



SIP INDUSTRIES  
SERAMPORE  
SINCE 1960

# SIP Industries



Quality Manufacturers Since 1960

## Utility Pipe Fittings Fusion Bonded Epoxy

# PRICE LIST

Effective : December 16, 2024

[www.sipindustries.com](http://www.sipindustries.com)

Toll Free 877-921-6111





## TABLE OF CONTENTS

GENERAL TERMS & CONDITIONS.....	Page : P002 - P004
FUSION BONDED EPOXY COMPACT MJ FITTINGS ANSI/AWWA C153/A21.53.....	Page : P005 - P018
FUSION BONDED EPOXY FULL BODY MJ FITTINGS ANSI/AWWA C110/A21.10.....	Page : P019 - P032
FUSION BONDED EPOXY COMPACT PUSH-ON FITTINGS ANSI/AWWA C153/A21.53.....	Page : P033 - P040
FUSION BONDED EPOXY FLANGE FITTINGS ANSI/AWWA C110/A21.10.....	Page : P041 - P054

- All dimensions are in inches unless noted otherwise.
- All weights are approximate in pounds unless noted otherwise.
- POA = Price on availability.
- R = Available multiple size reductions.

## SIP INDUSTRIES

### GENERAL TERMS AND CONDITIONS OF SALE

**1. Acceptance.** All sales by SIP Industries (Seller) are made pursuant to these Terms and Conditions. Submission of a purchase order to Seller, and/or acceptance of goods delivered by Seller, shall be deemed an acceptance of these Terms and Conditions by Purchaser. Please note that these Terms and Conditions may be modified from time to time; the applicable Terms and Conditions are those posted on SIP's website, [www.sipindustries.com](http://www.sipindustries.com), at the time that a purchase order is accepted or an agreement otherwise confirmed. Purchaser's alteration or addition to these Terms and Conditions, as same may be in effect from time to time, is expressly rejected unless accepted in writing by an authorized representative of Seller.

**2. Entire Agreement.** These Terms and Conditions, together with Seller's price list and Purchaser's purchase order, when accepted by Seller, shall be the entire agreement between Seller and Purchaser. Neither Seller nor Purchaser is relying on any representations, warranties or agreements except as expressly provided in these Terms and Conditions and in an accepted purchase order. To the extent of any conflict between the terms of a purchase order or any other documents submitted by Purchaser, on the one hand, and these Terms and Conditions, on the other, these Terms and Conditions shall govern.

**3. Prices.** Prices and descriptions of goods stated in Seller's price lists are subject to change without notice. Prices are subject to tariffs, raw material surcharges, labor disputes and shipping surcharges. To submit a purchase order, SIP Industries item numbers and part codes should be included. Seller's quotations are on globally sourced products unless otherwise noted. The ordering party is responsible to specify any required origin as required for end use. Quotations, if provided by Seller, expire sixty (60) days from the date provided unless otherwise agreed in writing.

**4. Terms.** Invoices are due and payable thirty (30) days from date of shipment, unless otherwise written on the invoice or confirmed in writing by Seller. A five percent (5%) late fee will be charged on all past-due accounts. If it becomes necessary to retain attorneys to collect an account, the Purchaser is liable for Seller's attorney's fees and other costs of collection.

**5. FOB point of shipment.** All prices are FOB point of shipment, unless otherwise agreed in writing. Seller's responsibility for goods therefore ceases and title passes to the Purchaser at the point of shipment; all claims for damages or losses in transit must be directed to the carrier with copy to Seller within ten (10) days of shipment.

**6. Delivery.** Seller shall have the right to select the freight carrier unless otherwise agreed. Seller has the right to substitute material with same function and design to accommodate unforeseen delays, shortages or restrictions.

**7. Cancellations, Changes and Returns.** All cancellations, changes and returns must be accepted in writing by an authorized representative of Seller, otherwise they will not be valid and binding on Seller. Seller will not be responsible for unauthorized returned product. It will be the responsibility of purchaser at their expense to have unauthorized product returned or disposed of. Seller shall not be obligated to accept any cancellation, change or return, but if it does so the following terms shall apply: (i) goods must be returned to Seller's facility, in the same condition in which they were accepted by Purchaser; (ii) a handling charge of thirty-five percent (35%) of the purchase price will be deducted from the credit given to Purchaser; and (iii) shipping charges, if not prepaid by Purchaser, will likewise be deducted from the credit given to Purchaser.

**8. Specially Manufactured Goods.** Unless otherwise agreed, specially-manufactured goods, including goods designed to the Purchaser's specifications, may not be cancelled or returned once work has begun to design or manufacture the goods unless an agreement is reached and confirmed in writing by Seller, including compensation to Seller for work thus far done with respect to the goods.

**9. Delays; Force Majeure.** Seller shall not be liable for any expenses, loss or damage resulting from any delay in delivery of goods or other failure of Seller's performance due to fire, floods, acts of god, strikes, labor disputes, labor shortages, riots, accidents, transportation delays or other causes beyond the reasonable control of Seller.

**10. Disclaimer regarding weights.** All stated weights are approximate and are given for inventory and shipping purposes only.

**11. Taxes.** Seller's prices do not include sales, excise or other taxes. Purchaser shall pay all such taxes. If Purchaser claims a tax exemption, Purchaser shall provide Seller with the necessary tax-exemption numbers and certificates. If Purchaser aims a tax exemption, Purchaser shall provide Seller with the necessary tax-exemption numbers and certificates. If Seller accepts an exemption but is later required by the taxing authority to pay taxes, Purchaser shall reimburse to Seller the amount of such taxes.

**12. Limited Warranty.** For a period of one calendar year from the date of shipment, Seller warrants that goods sold and delivered by Seller to Purchaser will conform to the number and type of goods described in the accepted purchase order and that such goods will be free from defects in material and workmanship.

THIS LIMITED WARRANTY IS SELLER'S SOLE AND EXCLUSIVE WARRANTY. SELLER MAKES NO OTHER WARRANTY OF ANY KIND, EXPRESS OR IMPLIED. SELLER DOES NOT WARRANT THAT THE GOODS ARE FIT FOR ANY PARTICULAR PURPOSE. SELLER DOES NOT WARRANT THAT THE GOODS ARE MERCHANTABILITY.

**13. Product Disclaimers.** All tooling required to manufacture products are the property of Seller even if tooling costs are incurred by Purchaser. Seller has the right to change product design, engineering, materials, tooling and processes that do not affect the intended use and application of the product. Seller will notify Purchaser if changes are substantial and may affect the application or appearance of the product. Furthermore, references to Buyer's specifications and similar requirements are only to describe the goods and do not give rise to any representation, warranty or other sales term.

Seller manufactures to industry standards and makes every effort to address applications of its products. Please see current technical advisory at Seller's web site, sipindustries.com, for up to date product support and recommendations. All product dimension, designs, technology, tooling, process, software, innovations, and drawings are considered intellectual property and are owned and confidential to Seller. Purchaser has no rights or privileges to SIP industries intellectual property including product applications without Seller's express written consent.

**14. Prompt notice required for Limited Warranty claims.** Buyer is responsible for promptly inspecting goods on delivery and notifying Seller, within sixty (60) days of delivery to Buyer, of any nonconformity or defect that would be discovered on a reasonable and customary inspection. Provided that such notice is given and that the warranty claim is made within one year, Seller will provide a replacement or price adjustment, in Seller's discretion, not to exceed the net sales price of the defective product. However, this warranty shall be of no force or effect absent such timely notice. Seller shall not in any event be responsible for labor, removal or installation charges incurred in connection with the replacement of defective goods.

**15. Conditions to Limited Warranty.** Purchaser shall notify Seller immediately upon discovery of a defect so that Seller may inspect the product in its installed condition. Seller shall not be responsible for defects or failures in goods of which it is not so notified; nor shall Seller be responsible for goods manufactured or sold by other parties or losses or impairments caused by such goods; nor shall Seller be responsible for defects or failure of goods due to improper installation, improper usage, normal or abnormal wear and tear, erosion or corrosion, improper storage, use or maintenance, vandalism, vehicular or other accidents, or storms or other forces beyond the control of the parties. Seller also shall not be responsible for goods that have been damaged by misuse, negligence or accident or that have been altered or repaired by any party other than Seller.

**16. Limitation on Liability.** In the event any remedy hereunder fails of its essential purpose and monetary damages may be imposed, Seller's liability, whether founded in contract or tort (including negligence), arising out of or resulting from (i) the Purchase Order and resulting contract or the performance or breach thereof, or (ii) the design, manufacture, delivery, sale, repair, replacement or use of the goods, shall not exceed the cost of the goods at issue in the claim. NOTWITHSTANDING ANYTHING CONTAINED HEREIN TO THE CONTRARY, SELLER SHALL NOT BE LIABLE TO PURCHASER OR ANY OTHER PERSON FOR CONSEQUENTIAL, INCIDENTAL, SPECIAL, EXEMPLARY, PUNITIVE OR OTHER INDIRECT DAMAGES, INCLUDING, WITHOUT LIMITATION, LOSS OF PROFITS, RECALL-RELATED EXPENSES, AND LOSS OF USE OF THE GOODS.

**17. Purchaser specifications.** If Seller has designed the goods using information provided by Purchaser, Seller shall not be responsible for design errors resulting from inaccurate or incomplete information supplied by Purchaser. If

Purchaser has provided specifications or a model or sample from which a good is designed and manufactured, Seller shall not be responsible for any defect, error or inadequacy provided that the good is designed or manufactured in compliance with Purchaser's specifications, model or sample.

**18. Solvency and Security Interest.** By submitting a Purchase Order, Buyer represents to Seller that Buyer is solvent and capable of timely fulfilling its payment and other obligations to Seller. Until the goods and any other indebtedness of Buyer have been paid in full, Buyer, its agents any successors: (i) will hold the goods subject to a security interest in favor of Seller allowing for the right or re-possession by Seller to the extent permitted by applicable law, (ii) will not alter, remove, destroy, or damage any identifying mark on the goods or their packaging, and (iii) will keep the goods separate from any other products.

**19. Governing law; venue.** All sales shall be governed by the law of the state of Texas. In the event that a lawsuit is filed between the parties on any claim arising out of or in connection with such sales, Seller and Purchaser agree that exclusive venue and jurisdiction shall be in the state or federal courts of Harris County, Texas.

**20. Attorney's fees and costs.** In the event of litigation between the parties with respect to the sale of goods, the prevailing party shall be entitled to recover its reasonable attorney's fees and costs, including expert witness fees.

# Utility Pipe Fittings Fusion Bonded Epoxy

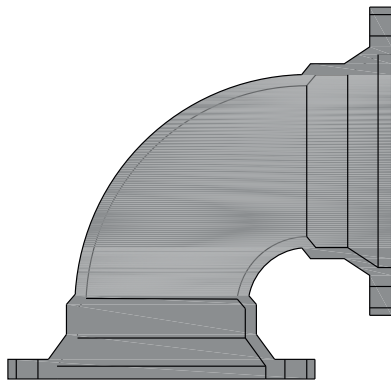

ANSI/AWWA C153/A21.53  
**COMPACT MJ FITTINGS**  
**FUSION BONDED EPOXY**

## PRICE LIST

Effective December 16, 2024



**BENDS : MJ X MJ  
90° (1/4)**

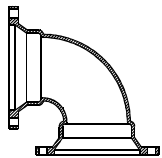

Size (in.)	Item No.	Crt. Qty.	List Price (\$)	Wt. (lb.)
2	CDMJB9002E	36	174.00	14
3	CDMJB9003E	80	195.00	23
4	CDMJB9004E	60	195.00	27
6	CDMJB9006E	36	317.00	39
8	CDMJB9008E	18	463.00	57
10	CDMJB9010E	12	725.00	89
12	CDMJB9012E	8	973.00	108
14	CDMJB9014E	4	1,772.00	210
16	CDMJB9016E	2	2,369.00	264
18	CDMJB9018E		2,958.00	335
20	CDMJB9020E		4,010.00	400
24	CDMJB9024E		5,995.00	565
30	CDMJB9030E		9,635.00	960
36	CDMJB9036E		15,050.00	1499
42	CDMJB9042E		25,601.00	2205
48	CDMJB9048E		31,289.00	2990

**BENDS :MJ X MJ  
45° (1/8)**

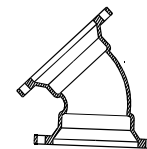

Size (in.)	Item No.	Crt. Qty.	List Price (\$)	Wt. (lb.)
2	CDMJB4502E	36	139.00	13
3	CDMJB4503E	80	174.00	21
4	CDMJB4504E	100	160.00	23
6	CDMJB4506E	48	259.00	32
8	CDMJB4508E	27	376.00	46
10	CDMJB4510E	18	542.00	70
12	CDMJB4512E	12	805.00	86
14	CDMJB4514E	8	1,379.00	164
16	CDMJB4516E	8	1,576.00	202
18	CDMJB4518E	2	2,451.00	250
20	CDMJB4520E		2,667.00	305
24	CDMJB4524E		3,646.00	405
30	CDMJB4530E		8,091.00	783
36	CDMJB4536E		10,832.00	1142
42	CDMJB4542E		18,019.00	1610
48	CDMJB4548E		23,612.00	2090

**BENDS : MJ X MJ  
22½° (1/16)**

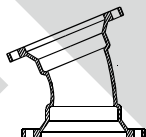

Size (in.)	Item No.	Crt. Qty.	List Price (\$)	Wt. (lb.)
2	CDMJB2202E	50	181.00	9
3	CDMJB2203E	50	112.00	16
4	CDMJB2204E	100	168.00	18
6	CDMJB2206E	48	237.00	32
8	CDMJB2208E	27	367.00	46
10	CDMJB2210E	18	539.00	64
12	CDMJB2212E	12	707.00	84
14	CDMJB2214E	8	1,396.00	148
16	CDMJB2216E	8	1,495.00	178
18	CDMJB2218E	2	2,089.00	255
20	CDMJB2220E	2	2,794.00	310
24	CDMJB2224E	2	3,393.00	412
30	CDMJB2230E		6,801.00	796
36	CDMJB2236E		9,939.00	1160
42	CDMJB2242E		14,844.00	1350
48	CDMJB2248E		19,370.00	1760

**BENDS : MJ X MJ  
11¼° (1/32)**

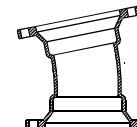

Size (in.)	Item No.	Crt. Qty.	List Price (\$)	Wt. (lb.)
2	CDMJB1102E	30	216.00	8
3	CDMJB1103E	30	126.00	14
4	CDMJB1104E	50	160.00	16
6	CDMJB1106E	60	246.00	30
8	CDMJB1108E	27	333.00	42
10	CDMJB1110E	18	565.00	58
12	CDMJB1112E	16	655.00	74
14	CDMJB1114E	8	1,558.00	130
16	CDMJB1116E	4	1,550.00	158
18	CDMJB1118E	2	2,353.00	205
20	CDMJB1120E	2	2,599.00	245
24	CDMJB1124E	2	3,167.00	315
30	CDMJB1130E		6,776.00	800
36	CDMJB1136E		9,261.00	1165
42	CDMJB1142E		13,895.00	1180
48	CDMJB1148E		18,824.00	1475

CALL FOR BARE/BARE FITTINGS

\* AWWA C110



**BENDS : MJ X PE**  
**90° (1/4)**

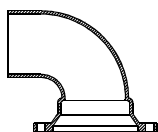

Size (in.)	Item No.	Crt. Qty.	List Price (\$)	Wt. (lb.)
3	CDMJPB9003E	72	188.00	16
4	CDMJPB9004E	60	242.00	22
6	CDMJPB9006E	36	413.00	41
8	CDMJPB9008E	9	568.00	61
10	CDMJPB9010E	12	893.00	83
12	CDMJPB9012E	8	1,162.00	114
14	CDMJPB9014E	4	2,009.00	197
16	CDMJPB9016E	4	3,074.00	248
18	CDMJPB9018E		5,179.00	325
20	CDMJPB9020E		5,773.00	390
24	CDMJPB9024E		6,497.00	575
30	CDMJPB9030E		10,350.00	945
36	CDMJPB9036E		22,154.00	1362
42	CDMJPB9042E		23,720.00	2068
48	CDMJPB9048E		42,162.00	

**BENDS : MJ X PE**  
**45° (1/8)**

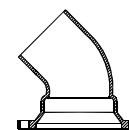

Size (in.)	Item No.	Crt. Qty.	List Price (\$)	Wt. (lb.)
3	CDMJPB4503E	100	160.00	13
4	CDMJPB4504E	100	185.00	19
6	CDMJPB4506E	24	308.00	34
8	CDMJPB4508E	24	482.00	49
10	CDMJPB4510E	18	723.00	72
12	CDMJPB4512E	12	1,006.00	98
14	CDMJPB4514E	8	1,605.00	148
16	CDMJPB4516E	8	1,927.00	184
18	CDMJPB4518E	2	4,172.00	235
20	CDMJPB4520E		4,350.00	290
24	CDMJPB4524E		4,406.00	390
30	CDMJPB4530E		8,556.00	772
36	CDMJPB4536E		19,836.00	1056
42	CDMJPB4542E		21,141.00	1505
48	CDMJPB4548E		26,812.00	2055

**BENDS : MJ X PE**  
**22½° (1/16)**

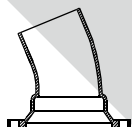

Size (in.)	Item No.	Crt. Qty.	List Price (\$)	Wt. (lb.)
3	CDMJPB2203E	100	135.00	12
4	CDMJPB2204E	100	186.00	18
6	CDMJPB2206E	48	311.00	29
8	CDMJPB2208E		481.00	43
10	CDMJPB2210E	18	646.00	61
12	CDMJPB2212E	12	841.00	81
14	CDMJPB2214E	8	1,663.00	133
16	CDMJPB2216E	8	2,594.00	166
18	CDMJPB2218E		2,958.00	235
20	CDMJPB2220E		4,120.00	300
24	CDMJPB2224E		5,785.00	395
30	CDMJPB2230E		7,174.00	600
36	CDMJPB2236E		POA	
42	CDMJPB2242E		POA	
48	CDMJPB2248E		POA	

**BENDS : MJ X PE**  
**11¼° (1/32)**

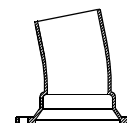

Size (in.)	Item No.	Crt. Qty.	List Price (\$)	Wt. (lb.)
3	CDMJPB1103E	100	135.00	12
4	CDMJPB1104E	100	179.00	17
6	CDMJPB1106E	48	294.00	27
8	CDMJPB1108E		455.00	39
10	CDMJPB1110E	18	570.00	52
12	CDMJPB1112E	12	730.00	70
14	CDMJPB1114E	8	1,358.00	122
16	CDMJPB1116E	8	1,684.00	148
18	CDMJPB1118E		2,958.00	235
20	CDMJPB1120E		4,120.00	300
24	CDMJPB1124E		5,794.00	465
30	CDMJPB1130E		14,343.00	562
42	CDMJPB1142E		27,911.00	

\* AWWA C110

**BENDS : MJ X FE**  
**90° (1/4)**

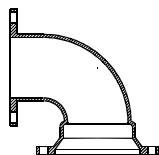

Size (in.)	Item No.	Crt. Qty.	List Price (\$)	Wt. (lb.)
3	CDMJFB9003E	72	207.00	20
4	CDMJFB9004E	48	258.00	26
6	CDMJFB9006E	27	443.00	47
8	CDMJFB9008E	18	738.00	68
10	CDMJFB9010E	12	1,149.00	102
12	CDMJFB9012E	8	1,637.00	134
14	CDMJFB9014E	4	2,800.00	223
16	CDMJFB9016E	4	3,406.00	303
24	CDMJFB9024E		9,143.00	625
30	CDMJFB9030E		15,973.00	1020

**BENDS : MJ X FE**  
**45° (1/8)**

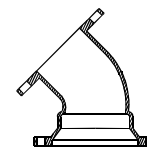

Size (in.)	Item No.	Crt. Qty.	List Price (\$)	Wt. (lb.)
3	CDMJFB4503E	32	249.00	17
4	CDMJFB4504E	100	255.00	24
6	CDMJFB4506E	48	373.00	39
8	CDMJFB4508E	27	709.00	57
10	CDMJFB4510E	18	1,074.00	83
12	CDMJFB4512E	12	1,543.00	111
14	CDMJFB4514E	8	2,271.00	208
16	CDMJFB4516E	8	3,166.00	300
24	CDMJFB4524E		6,799.00	617
30	CDMJFB4530E		26,450.00	1014

**BENDS : MJ X FE**  
**22½° (1/16)**

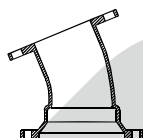

Size (in.)	Item No.	Crt. Qty.	List Price (\$)	Wt. (lb.)
3	CDMJFB2203E	24	381.00	18
4	CDMJFB2204E	100	325.00	27
6	CDMJFB2206E	48	413.00	36
8	CDMJFB2208E	27	639.00	53
10	CDMJFB2210E	18	928.00	100
12	CDMJFB2212E	12	1,348.00	145
30	CDMJFB2230E		24,624.00	

**BENDS : MJ X FE**  
**11¼° (1/32)**

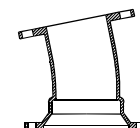

Size (in.)	Item No.	Crt. Qty.	List Price (\$)	Wt. (lb.)
4	CDMJFB1104E	100	285.00	20
6	CDMJFB1106E	48	401.00	30
8	CDMJFB1108E	27	531.00	50
10	CDMJFB1110E	18	871.00	74
12	CDMJFB1112E	12	1,115.00	85

CALL FOR BARE/BARE FITTINGS

Size (in.)	Item No.	Crt. Qty.	List Price (\$)	Wt. (lb.)
2 X 2	CDMJT0202E		216.00	22
3 X 2	CDMJT0302E		455.00	43
3 X 3	CDMJT0303E	50	260.00	28
4 X 2	CDMJT0402E	36	394.00	29
4 X 3	CDMJT0403E	16	305.00	35
4 X 4	CDMJT0404E	60	285.00	32
6 X 2	CDMJT0602E		POA	42
6 X 3	CDMJT0603E	12	377.00	42
6 X 4	CDMJT0604E	36	461.00	46
6 X 4 X 6	CDMJT060406E	12	POA	60
6 X 6	CDMJT0606E	24	458.00	56
6 X 6 X 8	CDMJT060608E	25	POA	75

**TEES : MJ X MJ**

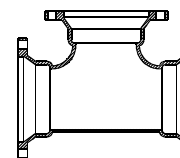

Size (in.)	Item No.	Crt. Qty.	List Price (\$)	Wt. (lb.)
8 X 3	CDMJT0803E	9	584.00	52
8 X 4	CDMJT0804E	27	488.00	60
8 X 6	CDMJT0806E	18	568.00	72
8 X 6 X 6	CDMJT080606E	9	POA	75
8 X 6 X 8	CDMJT080608E	9	POA	85
8 X 8	CDMJT0808E	18	687.00	86
10X 3	CDMJT1003E	6	760.00	75
10X 4	CDMJT1004E	18	790.00	78
10X 6	CDMJT1006E	12	725.00	90

\* AWWA C110

Contd.....

**TEES : MJ X MJ**  
Contd.....

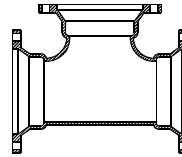

Size (in.)	Item No.	Crt. Qty.	List Price (\$)	Wt. (lb.)
10X 8	CDMJT1008E	12	849.00	105
10X10	CDMJT1010E	12	970.00	120
12X 3	CDMJT1203E		1,031.00	90
12X 4	CDMJT1204E	12	964.00	94
12X 6	CDMJT1206E	8	916.00	110
12X 8	CDMJT1208E	8	1,056.00	125
12X10	CDMJT1210E	8	1,427.00	140
12X12	CDMJT1212E	8	1,354.00	160
14X 6	CDMJT1406E	8	1,594.00	182
14X 8	CDMJT1408E	8	1,806.00	206
14X10	CDMJT1410E	8	2,324.00	228
14X12	CDMJT1412E	4	2,494.00	234
14X14	CDMJT1414E	4	2,451.00	280
16X 4	CDMJT1604E		3,409.00	
16X 6	CDMJT1606E	4	2,058.00	228
16X 8	CDMJT1608E	4	2,048.00	248
16X10	CDMJT1610E	2	2,848.00	264
16X12	CDMJT1612E	4	2,670.00	280
16X14	CDMJT1614E	4	3,510.00	316
16X16	CDMJT1616E	4	3,087.00	322
18X 4	CDMJT1804E		4,804.00	
18X 6	CDMJT1806E		2,963.00	287
18X 8	CDMJT1808E		3,206.00	295
18X10	CDMJT1810E		3,165.00	325
18X12	CDMJT1812E		3,805.00	340
18X14	CDMJT1814E		4,750.00	380
18X16	CDMJT1816E		4,958.00	425
18X18	CDMJT1818E		4,955.00	450
20X 6	CDMJT2006E		3,331.00	320
20X 8	CDMJT2008E		3,123.00	366
20X10	CDMJT2010E		4,485.00	370
20X12	CDMJT2012E		4,216.00	395
20X14	CDMJT2014E		5,082.00	475
20X16	CDMJT2016E		4,148.00	505
20X18	CDMJT2018E		6,533.00	505
20X20	CDMJT2020E		4,568.00	550
24X 6	CDMJT2406E		3,660.00	415
24X 8	CDMJT2408E		4,057.00	445
24X10	CDMJT2410E		5,343.00	470
24X12	CDMJT2412E		4,631.00	500

Size (in.)	Item No.	Crt. Qty.	List Price (\$)	Wt. (lb.)
24X14	CDMJT2414E		6,281.00	550
24X16	CDMJT2416E		5,855.00	580
24X18	CDMJT2418E		6,775.00	625
24X20	CDMJT2420E		7,345.00	660
24X24	CDMJT2424E		6,779.00	720
30X 4	CDMJT3004E		9,627.00	
30X 6	CDMJT3006E		6,692.00	742
30X 8	CDMJT3008E		7,558.00	755
30X10	CDMJT3010E		12,336.00	
30X12	CDMJT3012E		8,483.00	817
30X16	CDMJT3016E		9,805.00	931
30X18	CDMJT3018E		14,015.00	1085
30X20	CDMJT3020E		10,367.00	995
30X24	CDMJT3024E		10,839.00	1389
30X30	CDMJT3030E		13,890.00	1318
36X 6	CDMJT3606E		13,153.00	1000
36X 8	CDMJT3608E		13,019.00	1050
36X10	CDMJT3610E		11,300.00	
36X12	CDMJT3612E		11,274.00	1150
36X16	CDMJT3616E		12,166.00	1167
36X18	CDMJT3618E		20,475.00	1505
36X20	CDMJT3620E		21,403.00	1520
36X24	CDMJT3624E		15,270.00	1498
36X30	CDMJT3630E		17,124.00	2381
36X36	CDMJT3636E		20,278.00	2065
42X 6	CDMJT4206E		24,314.00	1800
42X 8	CDMJT4208E		24,931.00	1980
42X12	CDMJT4212E		27,293.00	1950
42X16	CDMJT4216E		25,753.00	2040
42X18	CDMJT4218E		27,688.00	2195
42X20	CDMJT4220E		27,688.00	2235
42X24	CDMJT4224E		24,675.00	2270
42X30	CDMJT4230E		25,127.00	2608
42X36	CDMJT4236E		32,117.00	3000
42X42	CDMJT4242E		34,064.00	3175
48X 6	CDMJT4806E		38,939.00	2155
48X 8	CDMJT4808E		40,463.00	
48X12	CDMJT4812E		31,557.00	2620
48X16	CDMJT4816E		38,832.00	2650
48X18	CDMJT4818E		38,832.00	

\* AWWA C110

Contd.....

CALL FOR BARE/BARE FITTINGS

**TEES : MJ X MJ**  
Contd.....

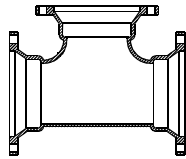

Size (in.)	Item No.	Crt. Qty.	List Price (\$)	Wt. (lb.)
48X20	CDMJT4820E		38,832.00	
48X24	CDMJT4824E		30,341.00	2870
48X30	CDMJT4830E		47,330.00	3050
48X36	CDMJT4836E		42,803.00	3900
48X42	CDMJT4842E		52,440.00	4100
48X48	CDMJT4848E		45,697.00	4250

**TEES : MJ X PE X MJ**

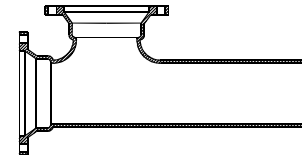

Size (in.)	Item No.	Crt. Qty.	List Price (\$)	Wt. (lb.)
6	CDMJPEMJT06E		539.00	57
8 X 6	CDMJPEMJT0806E		POA	69
8	CDMJPEMJT08E	9	797.00	77
10	CDMJPEMJT10E		POA	120
12	CDMJPEMJT12E		1,804.00	

**TEES : MJ X FE**

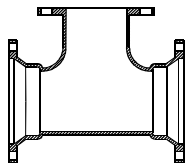

Size (in.)	Item No.	Crt. Qty.	List Price (\$)	Wt. (lb.)
3 X 3	CDMJFT0303E	40	327.00	30
4 X 2	CDMJFT0402E		POA	53
4 X 3	CDMJFT0403E	16	365.00	34
4 X 4	CDMJFT0404E	36	361.00	38
6 X 3	CDMJFT0603E	12	531.00	51
6 X 4	CDMJFT0604E	36	558.00	54
6 X 6	CDMJFT0606E	24	598.00	62
8 X 3	CDMJFT0803E		958.00	
8 X 4	CDMJFT0804E	27	663.00	79
8 X 6	CDMJFT0806E	18	633.00	80
8 X 8	CDMJFT0808E	18	878.00	90
10X 4	CDMJFT1004E	6	910.00	89
10X 6	CDMJFT1006E	8	1,140.00	110
10X 8	CDMJFT1008E	6	1,224.00	115
10X10	CDMJFT1010E	4	1,530.00	130
12X 4	CDMJFT1204E	8	1,220.00	117
12X 6	CDMJFT1206E	8	1,304.00	133
12X 8	CDMJFT1208E	8	1,471.00	135
12X10	CDMJFT1210E	4	1,639.00	150
12X12	CDMJFT1212E	4	2,028.00	170
14X 6	CDMJFT1406E	8	2,058.00	185
14X 8	CDMJFT1408E		POA	225
14X10	CDMJFT1410E	8	2,864.00	244
14X12	CDMJFT1412E	8	3,146.00	284
14X14	CDMJFT1414E	8	3,440.00	305
16X 6	CDMJFT1606E	2	2,324.00	210

Size (in.)	Item No.	Crt. Qty.	List Price (\$)	Wt. (lb.)
16X 8	CDMJFT1608E	2	2,790.00	260
16X10	CDMJFT1610E	4	3,355.00	287
16X12	CDMJFT1612E	4	3,457.00	312
16X14	CDMJFT1614E	4	POA	348
16X16	CDMJFT1616E	4	4,776.00	374
18X 6	CDMJFT1806E	4	2,894.00	320
18X 8	CDMJFT1808E	4	3,789.00	352
18X12	CDMJFT1812E		POA	358
18X18	CDMJFT1818E		10,590.00	445
20X 6	CDMJFT2006E	4	4,029.00	362
20X 8	CDMJFT2008E		8,220.00	384
20X10	CDMJFT2010E		POA	
24X 6	CDMJFT2406E	2	4,598.00	408
24X 8	CDMJFT2408E		4,944.00	472
24X10	CDMJFT2410E		8,634.00	
24X12	CDMJFT2412E	2	6,464.00	580
24X16	CDMJFT2416E	2	8,130.00	745
24X18	CDMJFT2418E		POA	
24X20	CDMJFT2420E		POA	
24X24	CDMJFT2424E		9,533.00	923
30X 6	CDMJFT3006E		9,627.00	805
30X 8	CDMJFT3008E		POA	695
30X12	CDMJFT3012E		12,185.00	715
30X16	CDMJFT3016E		POA	1187
30X24	CDMJFT3024E		POA	
36X 6	CDMJFT3606E		16,409.00	1175
36X12	CDMJFT3612E		POA	
36X16	CDMJFT3616E		POA	1475
36X24	CDMJFT3624E		28,450.00	
36X36	CDMJFT3636E		POA	
42X24	CDMJFT4224E		POA	
42X30	CDMJFT4230E		34,434.00	

CALL FOR BARE/BARE FITTINGS

\* AWWA C110

**MJ X SWIVEL HYDRANT TEE  
(W/SWIVEL GLAND) ANCHOR TEE**

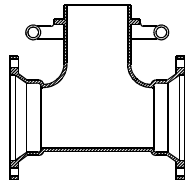

Size (in.)	Item No.	Crt. Qty.	List Price (\$)	Wt. (lb.)
4 X 4	CDMJHT0404E		POA	
6 X 6	CDMJHT0606E	24	528.00	66
8 X 6	CDMJHT0806E	18	660.00	86
8 X 8	CDMJHT0808E	16	1,047.00	105
10X 6	CDMJHT1006E	12	813.00	110
10X 8	CDMJHT1008E	4	1,187.00	120
12X 6	CDMJHT1206E	8	942.00	128
12X 8	CDMJHT1208E	4	1,356.00	130
14X 6	CDMJHT1406E	8	2,335.00	211
16X 6	CDMJHT1606E	4	1,669.00	280
16X 8	CDMJHT1608E	4	3,896.00	298
18X 6	CDMJHT1806E		3,104.00	280
20X 6	CDMJHT2006E		3,085.00	360
24X 6	CDMJHT2406E		4,085.00	465
30X 6	CDMJHT3006E		13,247.00	
36X 6	CDMJHT3606E		14,868.00	

**CROSSES : MJ X MJ**

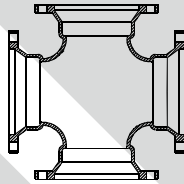

Size (in.)	Item No.	Crt. Qty.	List Price (\$)	Wt. (lb.)
3 X 3	CDMJX0303E		339.00	40
4 X 3	CDMJX0403E		401.00	49
4 X 4	CDMJX0404E	12	571.00	42
6 X 4	CDMJX0604E	6	622.00	68
6 X 6	CDMJX0606E	16	722.00	80
8 X 4	CDMJX0804E	6	986.00	100
8 X 6	CDMJX0806E	12	722.00	105
8 X 8	CDMJX0808E	12	708.00	110
10X 4	CDMJX1004E	4	960.00	120
10X 6	CDMJX1006E	12	929.00	125
10X 8	CDMJX1008E	8	1,153.00	130
10X10	CDMJX1010E	8	1,216.00	145
12X 4	CDMJX1204E	8	1,187.00	123
12X 6	CDMJX1206E	8	1,168.00	140
12X 8	CDMJX1208E	8	1,344.00	155

Size (in.)	Item No.	Crt. Qty.	List Price (\$)	Wt. (lb.)
12X10	CDMJX1210E	4	2,123.00	187
12X12	CDMJX1212E	8	2,123.00	215
14X 6	CDMJX1406E	8	2,117.00	210
14X 8	CDMJX1408E	8	2,392.00	230
14X10	CDMJX1410E		POA	255
14X12	CDMJX1412E		4,017.00	270
14X14	CDMJX1414E	4	3,669.00	336
16X 6	CDMJX1606E	4	2,544.00	250
16X 8	CDMJX1608E		2,941.00	264
16X10	CDMJX1610E		3,778.00	285
16X12	CDMJX1612E		4,040.00	310
16X16	CDMJX1616E		5,876.00	390
18X 6	CDMJX1806E		6,816.00	
18X10	CDMJX1810E		7,225.00	
18X12	CDMJX1812E		6,685.00	437
18X18	CDMJX1818E		7,077.00	657
20X 6	CDMJX2006E		5,963.00	
20X 8	CDMJX2008E		4,853.00	440
20X10	CDMJX2010E		5,917.00	
20X12	CDMJX2012E		4,669.00	558
20X16	CDMJX2016E		7,680.00	
20X18	CDMJX2018E		7,885.00	698
20X20	CDMJX2020E		10,563.00	798
24X 6	CDMJX2406E		5,436.00	481
24X 8	CDMJX2408E		5,647.00	500
24X10	CDMJX2410E		10,270.00	
24X12	CDMJX2412E		6,829.00	620
24X16	CDMJX2416E		8,130.00	720
24X18	CDMJX2418E		9,802.00	868
24X20	CDMJX2420E		11,452.00	1014
24X24	CDMJX2424E		10,141.00	1038
30X 6	CDMJX3006E		15,009.00	
30X 8	CDMJX3008E		14,619.00	
30X12	CDMJX3012E		13,530.00	1130
30X16	CDMJX3016E		21,518.00	
30X24	CDMJX3024E		21,831.00	1640
30X30	CDMJX3030E		21,996.00	1840
36X24	CDMJX3624E		28,848.00	1955
36X36	CDMJX3636E		32,044.00	2655
42X12	CDMJX4212E		29,577.00	
42X16	CDMJX4216E		30,995.00	
42X24	CDMJX4224E		33,245.00	
42X30	CDMJX4230E		52,792.00	
42X36	CDMJX4236E		59,431.00	3375

\* AWWA C110

Contd.....

CALL FOR BARE/BARE FITTINGS

**CROSSES : MJ X MJ**

Contd.....

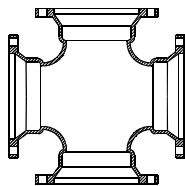

Size (in.)	Item No.	Crt. Qty.	List Price (\$)	Wt. (lb.)
42X42	CDMJX4242E		66,947.00	
48X12	CDMJX4812E		40,519.00	
48X16	CDMJX4816E		42,586.00	
48X24	CDMJX4824E		60,987.00	
48X30	CDMJX4830E		64,575.00	4506
48X36	CDMJX4836E		64,866.00	4700
48X42	CDMJX4842E		65,057.00	
48X48	CDMJX4848E		62,548.00	5000

**TEES : MJ TANGENTIAL**

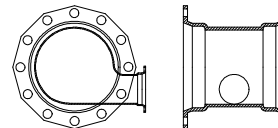

Size (in.)	Item No.	Crt. Qty.	List Price (\$)	Wt. (lb.)
16 X 6	CDMJTLT1606E		POA	270
16 X 12	CDMJTLT1612E		POA	344
18 X 6	CDMJTLT1806E		POA	306
24 X 6	CDMJTLT2406E		POA	375
24 X 12	CDMJTLT2412E		POA	450

**TEES : MJ TAPPED 2"**

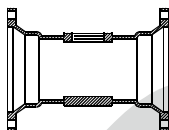

Size (in.)	Item No.	Crt. Qty.	List Price (\$)	Wt. (lb.)
3	CDMJTT0303E	48	293.00	18
4	CDMJTT0404E	48	339.00	25
6	CDMJTT0606E	48	411.00	35
8	CDMJTT0808E	36	637.00	55
10	CDMJTT1010E	18	1,304.00	70
12	CDMJTT1212E	8	1,772.00	85
16	CDMJTT1616E		1,911.00	164

**REDUCERS : MJ X FE**

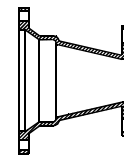

Size (in.)	Item No.	Crt. Qty.	List Price (\$)	Wt. (lb.)
4 X 3	CDMJFR0403E		POA	17
6 X 4	CDMJFR0604E	32	POA	23
8 X 6	CDMJFR0806E	18	POA	34
12X 8	CDMJFR1208E		POA	58
18X 8	CDMJFR1808E		POA	190
18X12	CDMJFR1812E		POA	198
24X12	CDMJFR2412E		POA	318

**REDUCERS : MJ X MJ**

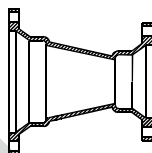

Size (in.)	Item No.	Crt. Qty.	List Price (\$)	Wt. (lb.)
3 X 2	CDMJR0302E		231.00	26
4 X 2	CDMJR0402E	36	231.00	35
4 X 3	CDMJR0403E	80	181.00	18
6 X 2	CDMJR0602E		307.00	45
6 X 3	CDMJR0603E	32	238.00	26
6 X 4	CDMJR0604E	64	201.00	24
8 X 3	CDMJR0803E		339.00	
8 X 4	CDMJR0804E	36	274.00	32
8 X 6	CDMJR0806E	36	270.00	36
10X 4	CDMJR1004E	9	428.00	46

Size (in.)	Item No.	Crt. Qty.	List Price (\$)	Wt. (lb.)
10X 6	CDMJR1006E	27	374.00	47
10X 8	CDMJR1008E	24	411.00	50
12X 4	CDMJR1204E	18	544.00	58
12X 6	CDMJR1206E	18	495.00	60
12X 8	CDMJR1208E	18	466.00	60
12X10	CDMJR1210E	18	550.00	64
14X 6	CDMJR1406E	4	1,122.00	110
14X 8	CDMJR1408E	12	1,113.00	115
14X10	CDMJR1410E	12	878.00	120
14X12	CDMJR1412E	4	878.00	130
16X 6	CDMJR1606E	4	1,275.00	140
16X 8	CDMJR1608E	4	1,229.00	155
16X10	CDMJR1610E	4	1,186.00	160
16X12	CDMJR1612E	6	1,046.00	161
16X14	CDMJR1614E	4	1,448.00	165
18X 4	CDMJR1804E		2,605.00	
18X 8	CDMJR1808E		1,814.00	200
18X10	CDMJR1810E		1,777.00	195

CALL FOR BARE/BARE FITTINGS

\* AWWA C110

Contd.....

**REDUCERS : MJ X MJ**

Contd.....

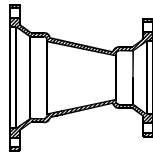

Size (in.)	Item No.	Crt. Qty.	List Price (\$)	Wt. (lb.)
18X12	CDMJR1812E		1,728.00	180
18X14	CDMJR1814E		2,261.00	200
18X16	CDMJR1816E	2	1,833.00	195
20X 6	CDMJR2006E		3,844.00	232
20X 8	CDMJR2008E		2,292.00	227
20X10	CDMJR2010E		2,405.00	220
20X12	CDMJR2012E		1,921.00	205
20X14	CDMJR2014E		1,915.00	200
20X16	CDMJR2016E		1,777.00	215
20X18	CDMJR2018E	2	2,359.00	225
24X 8	CDMJR2408E		4,710.00	
24X10	CDMJR2410E		5,367.00	
24X12	CDMJR2412E		2,944.00	305
24X14	CDMJR2414E		5,846.00	310
24X16	CDMJR2416E		3,055.00	320
24X18	CDMJR2418E		2,910.00	305
24X20	CDMJR2420E		3,482.00	320
30X12	CDMJR3012E		10,031.00	705
30X16	CDMJR3016E		6,520.00	633
30X18	CDMJR3018E		6,762.00	658
30X20	CDMJR3020E		6,403.00	628
30X24	CDMJR3024E		4,890.00	478
36X12	CDMJR3612E		13,121.00	1037
36X16	CDMJR3616E		8,626.00	1078
36X18	CDMJR3618E		15,894.00	1329
36X20	CDMJR3620E		9,914.00	975
36X24	CDMJR3624E		7,872.00	770
36X30	CDMJR3630E		8,563.00	650
42X16	CDMJR4216E		POA	
42X18	CDMJR4218E		POA	
42X20	CDMJR4220E		12,803.00	
42X24	CDMJR4224E		14,585.00	1356
42X30	CDMJR4230E		11,479.00	1083
42X36	CDMJR4236E		12,003.00	1114
48X16	CDMJR4816E		POA	
48X18	CDMJR4818E		POA	
48X20	CDMJR4820E		16,125.00	
48X24	CDMJR4824E		16,527.00	1700
48X30	CDMJR4830E		19,916.00	1779
48X36	CDMJR4836E		17,545.00	1641
48X42	CDMJR4842E		18,650.00	1462

**REDUCERS : PE X PE**

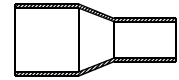

Size (in.)	Item No.	Crt. Qty.	List Price (\$)	Wt. (lb.)
4 X 3	CDMJRP0403E	48	151.00	16
6 X 3	CDMJRP0603E	48	241.00	22
6 X 4	CDMJRP0604E	25	238.00	30
8 X 4	CDMJRP0804E	36	346.00	34
8 X 6	CDMJRP0806E	16	365.00	40
10X 4	CDMJRP1004E		678.00	
10X 6	CDMJRP1006E	9	480.00	46
10X 8	CDMJRP1008E	9	494.00	49
12X 4	CDMJRP1204E		606.00	58
12X 6	CDMJRP1206E	9	606.00	59
12X 8	CDMJRP1208E	9	622.00	59
12X10	CDMJRP1210E	9	576.00	62
14X12	CDMJRP1412E		872.00	95
16X 6	CDMJRP1606E		1,025.00	128
16X 8	CDMJRP1608E		1,329.00	130
16X10	CDMJRP1610E		1,308.00	129
16X12	CDMJRP1612E		1,090.00	115
16X14	CDMJRP1614E		1,531.00	133
18X10	CDMJRP1810E		3,602.00	
18X12	CDMJRP1812E		3,306.00	
20X12	CDMJRP2012E		3,347.00	
20X16	CDMJRP2016E		3,407.00	
24X 8	CDMJRP2408E		3,061.00	
24X20	CDMJRP2420E		3,340.00	
30X16	CDMJRP3016E		13,900.00	690

**REDUCERS : MJ LARGE END (LEB)**

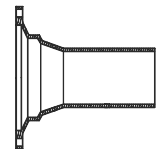

Size (in.)	Item No.	Crt. Qty.	List Price (\$)	Wt. (lb.)
3 X 2	CDMJRL0302E		POA	20
4 X 2	CDMJRL0402E		POA	30
4 X 3	CDMJRL0403E	40	188.00	18
6 X 3	CDMJRL0603E	30	267.00	30
6 X 4	CDMJRL0604E	60	299.00	26
8 X 4	CDMJRL0804E	50	350.00	35
8 X 6	CDMJRL0806E	48	301.00	33
10X 4	CDMJRL1004E	4	449.00	44
10X 6	CDMJRL1006E	18	468.00	48
10X 8	CDMJRL1008E	16	509.00	50

\* AWWA C110

Contd.....

CALL FOR BARE/BARE FITTINGS

**REDUCERS :  
MJ LARGE END (LEB)**

Contd.....

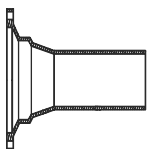

Size (in.)	Item No.	Crt. Qty.	List Price (\$)	Wt. (lb.)
12X 4	CDMJRL1204E	4	766.00	60
12X 6	CDMJRL1206E	18	615.00	60
12X 8	CDMJRL1208E	18	637.00	62
12X10	CDMJRL1210E	18	657.00	64
14X 6	CDMJRL1406E		1,098.00	112
14X 8	CDMJRL1408E		1,098.00	108
14X10	CDMJRL1410E		873.00	92
14X12	CDMJRL1412E		1,011.00	96
16X 6	CDMJRL1606E	4	1,511.00	148
16X 8	CDMJRL1608E		1,612.00	140
16X10	CDMJRL1610E	4	1,375.00	123
16X12	CDMJRL1612E	4	1,104.00	119
16X14	CDMJRL1614E		1,457.00	135
18X 8	CDMJRL1808E		1,851.00	195
18X10	CDMJRL1810E		POA	185

Size (in.)	Item No.	Crt. Qty.	List Price (\$)	Wt. (lb.)
18X12	CDMJRL1812E		1,982.00	175
18X14	CDMJRL1814E		2,261.00	200
18X16	CDMJRL1816E		2,174.00	192
20X10	CDMJRL2010E		2,378.00	210
20X12	CDMJRL2012E		3,126.00	210
20X14	CDMJRL2014E		1,940.00	205
20X16	CDMJRL2016E		1,833.00	238
20X18	CDMJRL2018E		POA	215
24X12	CDMJRL2412E		3,277.00	300
24X14	CDMJRL2414E		5,793.00	330
24X16	CDMJRL2416E		3,312.00	340
24X18	CDMJRL2418E		2,891.00	
24X20	CDMJRL2420E		6,140.00	
30X18	CDMJRL3018E		6,495.00	
30X24	CDMJRL3024E		8,253.00	
36X24	CDMJRL3624E		11,619.00	
36X30	CDMJRL3630E		8,527.00	
42X30	CDMJRL4230E		11,224.00	
42X36	CDMJRL4236E		POA	1114

**REDUCERS :  
MJ SMALL END (SEB)**

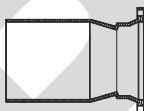

Size (in.)	Item No.	Crt. Qty.	List Price (\$)	Wt. (lb.)
3 X 2	CDMJRS0302E		POA	25
4 X 2	CDMJRS0402E		355.00	29
4 X 3	CDMJRS0403E	32	167.00	18
6 X 3	CDMJRS0603E	16	276.00	24
6 X 4	CDMJRS0604E	48	213.00	26
8 X 4	CDMJRS0804E	36	329.00	33
8 X 6	CDMJRS0806E	24	323.00	35
10X 4	CDMJRS1004E	4	449.00	44
10X 6	CDMJRS1006E	27	468.00	46
10X 8	CDMJRS1008E	12	496.00	49
12X 4	CDMJRS1204E	4	637.00	60
12X 6	CDMJRS1206E	27	664.00	58
12X 8	CDMJRS1208E	4	547.00	62
12X10	CDMJRS1210E	6	629.00	61
14X 6	CDMJRS1406E		POA	100
14X 8	CDMJRS1408E		POA	99
14X10	CDMJRS1410E	4	POA	97
14X12	CDMJRS1412E	4	POA	90
16X 6	CDMJRS1606E	4	1,385.00	125
16X 8	CDMJRS1608E	4	1,706.00	126

Size (in.)	Item No.	Crt. Qty.	List Price (\$)	Wt. (lb.)
16X10	CDMJRS1610E	4	1,679.00	124
16X12	CDMJRS1612E	4	1,375.00	122
16X14	CDMJRS1614E	4	POA	133
18X 8	CDMJRS1808E		1,413.00	170
18X10	CDMJRS1810E		POA	165
18X12	CDMJRS1812E		1,697.00	155
18X14	CDMJRS1814E		POA	175
18X16	CDMJRS1816E		1,276.00	170
20X 8	CDMJRS2008E		2,948.00	
20X10	CDMJRS2010E		2,573.00	200
20X12	CDMJRS2012E		1,923.00	170
20X14	CDMJRS2014E		2,221.00	190
20X16	CDMJRS2016E		2,095.00	185
20X18	CDMJRS2018E		POA	210
24X 8	CDMJRS2408E		4,266.00	
24X12	CDMJRS2412E		POA	275
24X14	CDMJRS2414E		POA	310
24X16	CDMJRS2416E		3,224.00	285
24X18	CDMJRS2418E		3,598.00	300
24X20	CDMJRS2420E		3,422.00	270
30X16	CDMJRS3016E		6,860.00	565
30X18	CDMJRS3018E		POA	648
30X20	CDMJRS3020E		7,062.00	560

\* AWWA C110

Contd.....



**REDUCERS : MJ SMALL  
END (SEB)** Contd.....

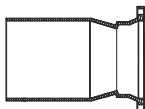

Size (in.)	Item No.	Crt. Qty.	List Price (\$)	Wt. (lb.)
30X24	CDMJRS3024E		POA	536
36X16	CDMJRS3616E		11,596.00	620
36X20	CDMJRS3620E		POA	874
36X24	CDMJRS3624E		8,924.00	790
36X30	CDMJRS3630E		9,908.00	788
42X24	CDMJRS4224E		15,204.00	1204
42X30	CDMJRS4230E		11,757.00	931
42X36	CDMJRS4236E		12,918.00	1023
48X30	CDMJRS4830E		23,755.00	1625
48X42	CDMJRS4842E		25,107.00	

**HYDRANT ADAPTERS :  
SWIVEL X SOLID  
WITH SWIVEL GLAND  
(ANCHOR COUPLING)**

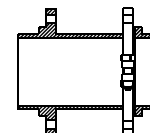

Size (in.)	Item No.	Crt. Qty.	List Price (\$)	Wt. (lb.)
4 X 13	CDMJHA0413E	18	301.00	29
6 X 13	CDMJHA0613E	36	498.00	46
6 X 18	CDMJHA0618E	24	604.00	55
6 X 24	CDMJHA0624E	24	733.00	59
6 X 36	CDMJHA0636E	6	1,024.00	75
6 X 48	CDMJHA0648E		1,322.00	94
8 X 13	CDMJHA0813E	24	720.00	54
8 X 18	CDMJHA0818E		POA	67
8 X 24	CDMJHA0824E		POA	82
8 X 48	CDMJHA0848E		POA	143
10 X 13	CDMJHA1013E		1,146.00	
12 X 13	CDMJHA1213E	8	1,559.00	120

**ADAPTERS : MJ X FLANGE**

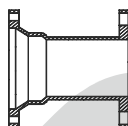

Size (in.)	Item No.	Crt. Qty.	List Price (\$)	Wt. (lb.)
3	CDMJFA03E	150	168.00	14
4	CDMJFA04E	120	214.00	23
6	CDMJFA06E	45	279.00	30
8	CDMJFA08E	45	422.00	46
10	CDMJFA10E	30	722.00	62
12	CDMJFA12E	24	924.00	98
14	CDMJFA14E	20	1,392.00	143
16	CDMJFA16E	10	1,612.00	170
18	CDMJFA18E	2	2,416.00	220
20	CDMJFA20E	10	2,985.00	240
24	CDMJFA24E	2	3,596.00	322
30	CDMJFA30E		6,667.00	544
36	CDMJFA36E		9,550.00	798
42	CDMJFA42E		24,219.00	1214
48	CDMJFA48E		29,150.00	1600

**HYDRANT ADAPTERS :  
SWIVEL X SWIVEL  
WITH TWO-SWIVEL GLAND**

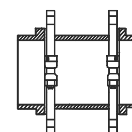

Size (in.)	Item No.	Crt. Qty.	List Price (\$)	Wt. (lb.)
6 X 12	CDMJHHA0612E		POA	30
6 X 13	CDMJHHA0613E		374.00	
6 X 18	CDMJHHA0618E		POA	49
6 X 24	CDMJHHA0624E		514.00	52
8 X 13	CDMJHHA0813E		540.00	

**HYDRANT ELL :  
SWIVEL X SWIVEL  
WITH TWO-SWIVEL GLAND**

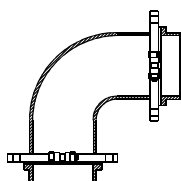

Size (in.)	Item No.	Crt. Qty.	List Price (\$)	Wt. (lb.)
6	CDMJHB9006E	24	542.00	50

**SWIVEL GLAND**

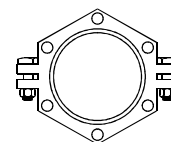

Size (in.)	Item No.	Crt. Qty.	List Price (\$)	Wt. (lb.)
4	CDMJGS04E	100	POA	8
6	CDMJGS06E	100	POA	9
8	CDMJGS08E	100	POA	11
12	CDMJGS12E	50	POA	24

\* AWWA C110

CALL FOR BARE/BARE FITTINGS

**MJ 45° LATERAL (WYES)**

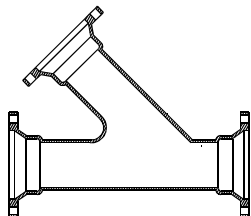

Size (in.)	Item No.	Crt. Qty.	List Price (\$)	Wt. (lb.)
3 X 3	CDMJL0303E		349.00	36
4 X 2	CDMJL0402E		707.00	
4 X 3	CDMJL0403E		388.00	40
4 X 4	CDMJL0404E	30	449.00	42
6 X 4	CDMJL0604E	12	462.00	53
6 X 6	CDMJL0606E	16	622.00	85
8 X 4	CDMJL0804E	6	931.00	75
8 X 6	CDMJL0806E	6	783.00	92
8 X 8	CDMJL0808E	6	980.00	105
10X 4	CDMJL1004E	4	1,512.00	147
10X 6	CDMJL1006E	4	1,593.00	156
10X 8	CDMJL1008E	4	1,731.00	172
10X10	CDMJL1010E	4	2,111.00	212
12X 4	CDMJL1204E	2	2,150.00	185
12X 6	CDMJL1206E	2	2,237.00	187
12X 8	CDMJL1208E	2	2,405.00	190
12X10	CDMJL1210E	2	2,821.00	245
12X12	CDMJL1212E	2	2,601.00	275
14X 6	CDMJL1406E	2	3,790.00	
14X 8	CDMJL1408E	2	7,308.00	
14X10	CDMJL1410E	2	4,031.00	
14X14	CDMJL1414E	2	4,600.00	474
16X 6	CDMJL1606E	2	3,032.00	300
16X 8	CDMJL1608E	2	3,554.00	349
16X10	CDMJL1610E		6,271.00	
16X12	CDMJL1612E		4,560.00	453
16X16	CDMJL1616E	2	5,542.00	575

**MJ PE CUTTING SLEEVES**

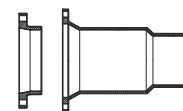

Size (in.)	Item No.	Crt. Qty.	List Price (\$)	Wt. (lb.)
4	CDMJPEESC04E	36	POA	50
6	CDMJPEESC06E	18	POA	62
8	CDMJPEESC08E	18	POA	90
10	CDMJPEESC10E	8	POA	105
12	CDMJPEESC12E	8	POA	128
16	CDMJPEESC16E		POA	275

**MJ X PE OFFSET**

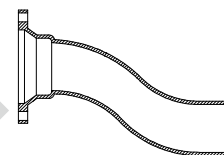

Size (in.)	Item No.	Crt. Qty.	List Price (\$)	Wt. (lb.)
3 X 6	CDMJOP0306E		307.00	32
3 X 12	CDMJOP0312E		409.00	42
3 X 18	CDMJOP0318E		500.00	54
3 X 24	CDMJOP0324E		554.00	58
4 X 6	CDMJOP0406E	12	459.00	45
4 X 12	CDMJOP0412E	12	564.00	56
4 X 18	CDMJOP0418E	16	678.00	62
4 X 24	CDMJOP0424E	6	746.00	70
6 X 6	CDMJOP0606E	12	543.00	55
6 X 12	CDMJOP0612E	8	704.00	68
6 X 18	CDMJOP0618E	8	994.00	97
6 X 24	CDMJOP0624E	4	1,212.00	116
8 X 6	CDMJOP0806E	4	810.00	84
8 X 12	CDMJOP0812E	4	1,138.00	110
8 X 18	CDMJOP0818E	4	1,282.00	124
8 X 24	CDMJOP0824E	3	1,343.00	147
10 X 6	CDMJOP1006E	6	1,343.00	127
10 X 12	CDMJOP1012E	4	1,773.00	130
10 X 18	CDMJOP1018E	4	1,949.00	160
10 X 24	CDMJOP1024E	4	2,350.00	169
12 X 6	CDMJOP1206E	4	2,021.00	115
12 X 12	CDMJOP1212E	4	2,046.00	198
12 X 18	CDMJOP1218E	4	2,784.00	270
12 X 24	CDMJOP1224E	2	3,443.00	335
12 X 30	CDMJOP1230E		2,117.00	225

CALL FOR BARE/BARE FITTINGS

\* AWWA C110

**MJ OFFSET**

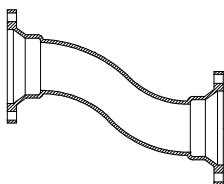

Size (in.)	Item No.	Crt. Qty.	List Price (\$)	Wt. (lb.)
3 X 6	CDMJO0306E		238.00	30
3 X 12	CDMJO0312E		346.00	40
3 X 18	CDMJO0318E		406.00	49
3 X 24	CDMJO0324E		480.00	55
4 X 6	CDMJO0406E	12	325.00	25
4 X 12	CDMJO0412E	12	421.00	55
4 X 18	CDMJO0418E	8	564.00	65
4 X 24	CDMJO0424E	16	651.00	75
6 X 6	CDMJO0606E	12	554.00	29
6 X 12	CDMJO0612E	16	720.00	69
6 X 18	CDMJO0618E	8	878.00	87
6 X 24	CDMJO0624E	8	1,109.00	107
8 X 6	CDMJO0806E	4	792.00	80
8 X 12	CDMJO0812E	4	1,025.00	104
8 X 18	CDMJO0818E	4	1,275.00	135
8 X 24	CDMJO0824E	3	1,825.00	141
10 X 6	CDMJO1006E	4	1,130.00	110
10 X 12	CDMJO1012E	4	1,490.00	135
10 X 18	CDMJO1018E	4	1,773.00	165
10 X 24	CDMJO1024E	4	3,153.00	175
12 X 6	CDMJO1206E	4	1,597.00	118
12 X 12	CDMJO1212E	4	1,773.00	203
12 X 18	CDMJO1218E	4	2,143.00	230
12 X 24	CDMJO1224E	2	3,030.00	277
12 X 30	CDMJO1230E		2,877.00	285
16 X 12	CDMJO1612E		8,352.00	305
16 X 18	CDMJO1618E		9,879.00	362
20 X 12	CDMJO2012E		11,770.00	437
20 X 18	CDMJO2018E		16,246.00	581

**MJ LONG SLEEVES**

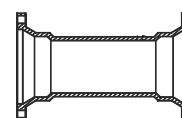

Size (in.)	Item No.	Crt. Qty.	List Price (\$)	Wt. (lb.)
2	CDMJLS02E	50	207.00	7
3	CDMJLS03E	126	172.00	18
4	CDMJLS04E	75	170.00	20
6	CDMJLS06E	36	298.00	36
8	CDMJLS08E	27	468.00	46
10	CDMJLS10E	18	554.00	62
12	CDMJLS12E	12	721.00	76
14	CDMJLS14E	8	1,224.00	140
16	CDMJLS16E	8	1,417.00	172
18	CDMJLS18E	5	2,010.00	225
20	CDMJLS20E	5	2,431.00	255
24	CDMJLS24E	5	2,931.00	335
30	CDMJLS30E		6,584.00	694
36	CDMJLS36E		8,179.00	1016
42	CDMJLS42E		12,181.00	1390
48	CDMJLS48E		16,756.00	1740

**MJ SHORT SLEEVES**

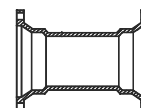

Size (in.)	Item No.	Crt. Qty.	List Price (\$)	Wt. (lb.)
2	CDMJSS02E		POA	12
3	CDMJSS03E	50	135.00	13
4	CDMJSS04E	125	131.00	17
6	CDMJSS06E	60	214.00	28
8	CDMJSS08E	45	305.00	38
10	CDMJSS10E	30	528.00	49
12	CDMJSS12E	20	595.00	56
14	CDMJSS14E	16	1,112.00	111
16	CDMJSS16E	16	1,379.00	130
18	CDMJSS18E	2	1,777.00	160
20	CDMJSS20E	8	2,174.00	195
24	CDMJSS24E	2	2,871.00	255
30	CDMJSS30E		5,832.00	500
36	CDMJSS36E		7,911.00	725
42	CDMJSS42E		11,138.00	877
48	CDMJSS48E		13,925.00	1406

CALL FOR BARE/BARE FITTINGS

\* AWWA C110

**MJ CAPS : SOLID**

Size (in.)	Item No.	Crt. Qty.	List Price (\$)	Wt. (lb.)
2	CDMJC02E		135.00	6
3	CDMJC03E	300	79.00	8
4	CDMJC04E	240	84.00	10
6	CDMJC06E	144	148.00	17
8	CDMJC08E	108	208.00	22
10	CDMJC10E	72	295.00	32
12	CDMJC12E	52	426.00	42
14	CDMJC14E	36	646.00	70
16	CDMJC16E	20	864.00	98
18	CDMJC18E	20	1,088.00	120
20	CDMJC20E	20	1,385.00	130
24	CDMJC24E	10	1,902.00	170
30	CDMJC30E	2	4,228.00	385
36	CDMJC36E	2	7,515.00	614
42	CDMJC42E		11,278.00	893
48	CDMJC48E		13,589.00	1067

**MJ CAPS : 2" TAPPED**

Size (in.)	Item No.	Crt. Qty.	List Price (\$)	Wt. (lb.)
2	CDMJCT02E		182.00	10
3	CDMJCT03E	300	147.00	8
4	CDMJCT04E	240	150.00	10
6	CDMJCT06E	144	214.00	17
8	CDMJCT08E	108	269.00	22
10	CDMJCT10E	72	361.00	32
12	CDMJCT12E	52	491.00	42
14	CDMJCT14E	36	760.00	70
16	CDMJCT16E	20	965.00	98
18	CDMJCT18E	20	1,234.00	120
20	CDMJCT20E	20	1,543.00	130
24	CDMJCT24E	10	2,010.00	170
30	CDMJCT30E	2	4,428.00	385
36	CDMJCT36E	2	7,715.00	614
42	CDMJCT42E		11,545.00	893
48	CDMJCT48E		13,858.00	1076

**MJ PLUGS : SOLID**

Size (in.)	Item No.	Crt. Qty.	List Price (\$)	Wt. (lb.)
2	CDMJPO2E		124.00	6
3	CDMJPO3E	100	110.00	8
4	CDMJPO4E	100	100.00	10
6	CDMJPO6E	144	185.00	22
8	CDMJPO8E	66	268.00	32
10	CDMJPO10E	52	459.00	40
12	CDMJPO12E	40	468.00	55
14	CDMJPO14E	16	966.00	70
16	CDMJPO16E	10	1,237.00	105
18	CDMJPO18E	4	1,584.00	125
20	CDMJPO20E	4	2,049.00	139
24	CDMJPO24E	4	2,843.00	180
30	CDMJPO30E	2	5,544.00	433
36	CDMJPO36E	2	8,563.00	674
42	CDMJPO42E		11,740.00	1067
48	CDMJPO48E		15,649.00	1313

**MJ PLUGS : 2" TAPPED**

Size (in.)	Item No.	Crt. Qty.	List Price (\$)	Wt. (lb.)
2	CDMJPT02E		174.00	5
3	CDMJPT03E	300	173.00	8
4	CDMJPT04E	240	166.00	10
6	CDMJPT06E	144	249.00	22
8	CDMJPT08E	108	333.00	32
10	CDMJPT10E	66	524.00	40
12	CDMJPT12E	24	532.00	55
14	CDMJPT14E	32	1,011.00	70
16	CDMJPT16E	20	1,301.00	105
18	CDMJPT18E	20	1,626.00	125
20	CDMJPT20E	20	2,041.00	139
24	CDMJPT24E	10	2,753.00	180
30	CDMJPT30E	2	5,537.00	433
36	CDMJPT36E	2	8,479.00	674
42	CDMJPT42E		11,977.00	1067
48	CDMJPT48E		15,918.00	1313

CALL FOR BARE/BARE FITTINGS

\* AWWA C110

# Utility Pipe Fittings Fusion Bonded Epoxy

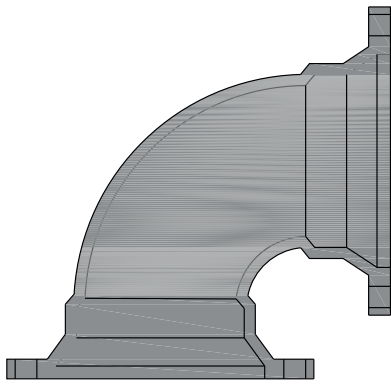

ANSI/AWWA C110/A21.10  
**FULL BODY MJ FITTINGS**  
**FUSION BONDED EPOXY**

**PRICE LIST**  
**Effective December 16, 2024**



**BENDS : MJ X MJ**  
**90° (1/4)**

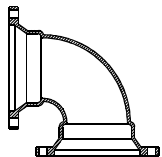

Size (in.)	Item No.	Crt. Qty.	List Price (\$)	Wt. (lb.)
2	XDMJB9002E	36	390.00	14
3	XDMJB9003E	36	361.00	35
4	XDMJB9004E	24	475.00	55
6	XDMJB9006E	12	726.00	85
8	XDMJB9008E	12	1,162.00	125
10	XDMJB9010E	4	1,961.00	190
12	XDMJB9012E	4	2,238.00	255
14	XDMJB9014E	0	4,066.00	380
16	XDMJB9016E	0	4,880.00	430
18	XDMJB9018E	0	7,164.00	545
20	XDMJB9020E	0	8,093.00	680
24	XDMJB9024E	0	10,607.00	1025
30	XDMJB9030E	0	18,832.00	1690
36	XDMJB9036E	0	25,679.00	2475
42	XDMJB9042E	0	43,043.00	3410
48	XDMJB9048E	0	58,001.00	4595

**BENDS :MJ X MJ**  
**45° (1/8)**

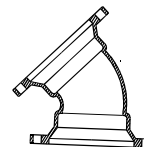

Size (in.)	Item No.	Crt. Qty.	List Price (\$)	Wt. (lb.)
2	XDMJB4502E	36	274.00	13
3	XDMJB4503E	0	307.00	30
4	XDMJB4504E	36	430.00	50
6	XDMJB4506E	12	650.00	75
8	XDMJB4508E	12	958.00	110
10	XDMJB4510E	4	1,459.00	155
12	XDMJB4512E	4	1,885.00	215
14	XDMJB4514E	0	2,958.00	270
16	XDMJB4516E	0	3,763.00	340
18	XDMJB4518E	0	4,955.00	420
20	XDMJB4520E	0	5,318.00	530
24	XDMJB4524E	0	6,844.00	755
30	XDMJB4530E	0	14,823.00	1380
36	XDMJB4536E	0	22,236.00	2095
42	XDMJB4542E	0	37,302.00	2955
48	XDMJB4548E	0	51,502.00	4080

**BENDS : MJ X MJ**  
**22½° (1/16)**

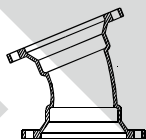

Size (in.)	Item No.	Crt. Qty.	List Price (\$)	Wt. (lb.)
2	XDMJB2202E	0	282.00	13
3	XDMJB2203E	0	307.00	30
4	XDMJB2204E	12	500.00	50
6	XDMJB2206E	12	672.00	75
8	XDMJB2208E	12	1,298.00	110
10	XDMJB2210E	4	1,609.00	160
12	XDMJB2212E	4	1,973.00	220
14	XDMJB2214E	0	3,014.00	275
16	XDMJB2216E	0	3,724.00	345
18	XDMJB2218E	0	4,858.00	430
20	XDMJB2220E	0	6,364.00	535
24	XDMJB2224E	0	6,735.00	765
30	XDMJB2230E	0	14,285.00	1400
36	XDMJB2236E	0	21,669.00	2135
42	XDMJB2242E	0	38,124.00	3020
48	XDMJB2248E	0	52,637.00	4170

**BENDS : MJ X MJ**  
**11¼° (1/32)**

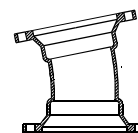

Size (in.)	Item No.	Crt. Qty.	List Price (\$)	Wt. (lb.)
2	XDMJB1102E	0	374.00	13
3	XDMJB1103E	0	301.00	30
4	XDMJB1104E	12	500.00	50
6	XDMJB1106E	12	748.00	75
8	XDMJB1108E	12	980.00	110
10	XDMJB1110E	0	1,609.00	160
12	XDMJB1112E	6	2,237.00	220
14	XDMJB1114E	0	3,014.00	275
16	XDMJB1116E	0	3,778.00	345
18	XDMJB1118E	0	5,025.00	430
20	XDMJB1120E	0	6,325.00	540
24	XDMJB1124E	0	8,597.00	770
30	XDMJB1130E	0	16,818.00	1410
36	XDMJB1136E	0	25,831.00	2145
42	XDMJB1142E	0	38,314.00	3035
48	XDMJB1148E	0	52,891.00	4190

CALL FOR BARE/BARE FITTINGS

**BENDS : MJ X PE**  
**90° (1/4)**

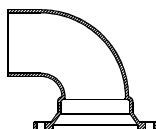

Size (in.)	Item No.	Crt. Qty.	List Price (\$)	Wt. (lb.)
3	XDMJBP9003E	0	365.00	35
4	XDMJBP9004E	8	521.00	50
6	XDMJBP9006E	12	972.00	80
8	XDMJBP9008E	12	1,524.00	120
10	XDMJBP9010E	8	1,961.00	170
12	XDMJBP9012E	4	2,628.00	255
14	XDMJBP9014E	0	5,502.00	330
16	XDMJBP9016E	0	4,487.00	410
18	XDMJBP9018E	0	5,875.00	600
20	XDMJBP9020E	0	7,339.00	775
24	XDMJBP9024E	0	11,122.00	985
30	XDMJBP9030E	0	18,954.00	1920
36	XDMJBP9036E	0	27,620.00	2310
42	XDMJBP9042E	0	45,097.00	3215
48	XDMJBP9048E	0	77,396.00	4345

**BENDS : MJ X PE**  
**45° (1/8)**

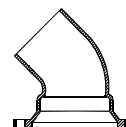

Size (in.)	Item No.	Crt. Qty.	List Price (\$)	Wt. (lb.)
3	XDMJBP4503E	24	317.00	32
4	XDMJBP4504E	50	481.00	45
6	XDMJBP4506E	12	810.00	70
8	XDMJBP4508E	24	1,224.00	105
10	XDMJBP4510E	12	1,737.00	155
12	XDMJBP4512E	4	2,217.00	215
14	XDMJBP4514E	4	2,787.00	258
16	XDMJBP4516E	4	3,253.00	320
18	XDMJBP4518E	0	4,462.00	455
20	XDMJBP4520E	0	5,647.00	664
24	XDMJBP4524E	2	7,981.00	715
30	XDMJBP4530E	0	15,250.00	1510
36	XDMJBP4536E	0	23,076.00	1930
42	XDMJBP4542E	0	41,727.00	2745
48	XDMJBP4548E	0	59,825.00	3820

**BENDS : MJ X PE**  
**22½° (1/16)**

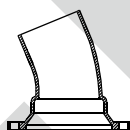

Size (in.)	Item No.	Crt. Qty.	List Price (\$)	Wt. (lb.)
3	XDMJBP2203E	24	961.00	32
4	XDMJBP2204E	24	474.00	50
6	XDMJBP2206E	0	726.00	70
8	XDMJBP2208E	0	1,090.00	105
10	XDMJBP2210E	0	1,651.00	160
12	XDMJBP2212E	0	2,268.00	220
14	XDMJBP2214E	4	POA	335
16	XDMJBP2216E	0	3,562.00	365
18	XDMJBP2218E	0	4,580.00	455
20	XDMJBP2220E	0	5,707.00	575
24	XDMJBP2224E	0	8,188.00	930
30	XDMJBP2230E	0	16,740.00	1540
36	XDMJBP2236E	0	23,555.00	1970
42	XDMJBP2242E	0	POA	2815

**BENDS : MJ X PE**  
**11¼° (1/32)**

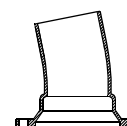

Size (in.)	Item No.	Crt. Qty.	List Price (\$)	Wt. (lb.)
3	XDMJBP1103E	24	629.00	32
4	XDMJBP1104E	24	948.00	50
6	XDMJBP1106E	24	1,236.00	70
8	XDMJBP1108E	16	1,090.00	105
12	XDMJBP1112E	0	1,603.00	220
14	XDMJBP1114E	0	6,587.00	260
16	XDMJBP1116E	2	8,098.00	365
18	XDMJBP1118E	0	POA	455
20	XDMJBP1120E	0	9,896.00	575
24	XDMJBP1124E	0	8,244.00	845
30	XDMJBP1130E	0	15,608.00	1305
36	XDMJBP1136E	0	23,673.00	2185
48	XDMJBP1148E	0	63,685.00	3945

CALL FOR BARE/BARE FITTINGS

**BENDS : MJ X FE**  
**90° (1/4)**

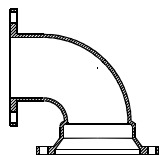

Size (in.)	Item No.	Crt. Qty.	List Price (\$)	Wt. (lb.)
4	XDMJFB9004E	0	524.00	53
6	XDMJFB9006E	0	730.00	75
8	XDMJFB9008E	2	1,130.00	115
10	XDMJFB9010E	0	1,637.00	177
12	XDMJFB9012E	0	2,689.00	246
16	XDMJFB9016E	0	4,683.00	465
18	XDMJFB9018E	0	6,000.00	577
20	XDMJFB9020E	0	7,208.00	745
24	XDMJFB9024E	0	13,559.00	1150

**BENDS : MJ X FE**  
**45° (1/8)**

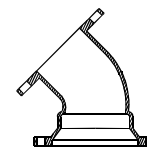

Size (in.)	Item No.	Crt. Qty.	List Price (\$)	Wt. (lb.)
4	XDMJFB4504E	0	439.00	45
6	XDMJFB4506E	0	682.00	69
8	XDMJFB4508E	0	1,066.00	105
10	XDMJFB4510E	0	1,646.00	155
12	XDMJFB4512E	0	2,137.00	215
16	XDMJFB4516E	0	3,626.00	360
18	XDMJFB4518E	0	4,858.00	422
20	XDMJFB4520E	0	6,823.00	543
24	XDMJFB4524E	0	10,355.00	903

**BENDS : MJ X FE**  
**22½° (1/16)**

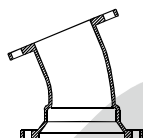

Size (in.)	Item No.	Crt. Qty.	List Price (\$)	Wt. (lb.)
4	XDMJFB2204E	0	879.00	45
6	XDMJFB2206E	0	601.00	69
8	XDMJFB2208E	0	1,031.00	105
10	XDMJFB2210E	0	1,496.00	155
12	XDMJFB2212E	0	2,311.00	215
16	XDMJFB2216E	0	3,256.00	373
18	XDMJFB2218E	0	3,587.00	422
20	XDMJFB2220E	0	10,087.00	575
24	XDMJFB2224E	0	9,537.00	800

**BENDS : MJ X FE**  
**11¼° (1/32)**

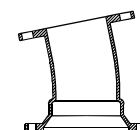

Size (in.)	Item No.	Crt. Qty.	List Price (\$)	Wt. (lb.)
4	XDMJFB1104E	0	820.00	45
6	XDMJFB1106E	0	689.00	69
8	XDMJFB1108E	0	1,016.00	105
10	XDMJFB1110E	0	2,299.00	155
12	XDMJFB1112E	0	2,071.00	215
16	XDMJFB1116E	0	3,682.00	360
18	XDMJFB1118E	0	4,480.00	422
20	XDMJFB1120E	0	10,087.00	575
24	XDMJFB1124E	0	9,537.00	800

**TEES : MJ X MJ**

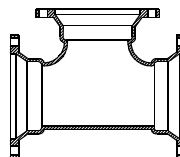

Size (in.)	Item No.	Crt. Qty.	List Price (\$)	Wt. (lb.)
2 X 2	XDMJT0202E	36	301.00	22
3 X 2	XDMJT0302E		474.00	43
3 X 3	XDMJT0303E		638.00	55
4 X 2	XDMJT0402E	24	1,275.00	65
4 X 3	XDMJT0403E		779.00	75
4 X 4	XDMJT0404E	12	795.00	80

Size (in.)	Item No.	Crt. Qty.	List Price (\$)	Wt. (lb.)
4 X 4 X 6	XDMJT040406E		POA	115
6 X 2	XDMJT0602E	12	1,058.00	100
6 X 3	XDMJT0603E	24	1,094.00	110
6 X 4	XDMJT0604E	12	1,146.00	115
6 X 6	XDMJT0606E	12	1,115.00	125
6 X 6 X 8	XDMJT060608E		POA	185

Contd.....

CALL FOR BARE/BARE FITTINGS



**TEES : MJ X MJ**  
Contd.....

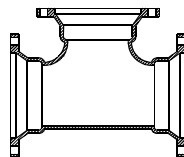

Size (in.)	Item No.	Crt. Qty.	List Price (\$)	Wt. (lb.)
8 X 3	XDMJT0803E		2,093.00	155
8 X 4	XDMJT0804E	9	1,644.00	165
8 X 6	XDMJT0806E	9	1,546.00	175
8 X 8	XDMJT0808E	9	1,671.00	185
10 X 3	XDMJT1003E		POA	216
10 X 4	XDMJT1004E	12	2,424.00	235
10 X 6	XDMJT1006E	4	2,512.00	250
10 X 8	XDMJT1008E	4	2,612.00	260
10 X 10	XDMJT1010E	4	3,116.00	310
12 X 3	XDMJT1203E		POA	290
12 X 4	XDMJT1204E	8	3,204.00	315
12 X 6	XDMJT1206E	4	2,984.00	325
12 X 8	XDMJT1208E	4	3,457.00	340
12 X 10	XDMJT1210E	4	3,964.00	390
12 X 12	XDMJT1212E	4	4,152.00	410
14 X 4	XDMJT1404E		5,762.00	383
14 X 6	XDMJT1406E	4	4,760.00	435
14 X 8	XDMJT1408E		4,921.00	450
14 X 10	XDMJT1410E		5,091.00	465
14 X 12	XDMJT1412E		5,417.00	495
14 X 14	XDMJT1414E		5,691.00	520
16 X 4	XDMJT1604E		7,264.00	600
16 X 6	XDMJT1606E		5,907.00	540
16 X 8	XDMJT1608E		6,015.00	550
16 X 10	XDMJT1610E		6,235.00	570
16 X 12	XDMJT1612E		6,455.00	590
16 X 14	XDMJT1614E		6,781.00	620
16 X 16	XDMJT1616E		7,522.00	650
18 X 4	XDMJT1804E		POA	528
18 X 6	XDMJT1806E		6,666.00	590
18 X 8	XDMJT1808E		6,836.00	605
18 X 10	XDMJT1810E		7,002.00	620
18 X 12	XDMJT1812E		7,225.00	640
18 X 14	XDMJT1814E		8,529.00	755
18 X 16	XDMJT1816E		8,867.00	785
18 X 18	XDMJT1818E		9,261.00	820
20 X 6	XDMJT2006E	2	8,994.00	725
20 X 8	XDMJT2008E	2	10,412.00	735
20 X 10	XDMJT2010E		8,529.00	755
20 X 12	XDMJT2012E	2	8,640.00	775

Size (in.)	Item No.	Crt. Qty.	List Price (\$)	Wt. (lb.)
20 X 14	XDMJT2014E		8,979.00	795
20 X 16	XDMJT2016E		10,547.00	945
20 X 18	XDMJT2018E		11,122.00	985
20 X 20	XDMJT2020E		9,730.00	1020
24 X 4	XDMJT2404E		12,793.00	985
24 X 6	XDMJT2406E		11,122.00	985
24 X 8	XDMJT2408E		11,290.00	1000
24 X 10	XDMJT2410E		13,443.00	1020
24 X 12	XDMJT2412E		11,630.00	1030
24 X 14	XDMJT2414E		11,916.00	1055
24 X 16	XDMJT2416E		12,273.00	1075
24 X 18	XDMJT2418E		15,801.00	1400
24 X 20	XDMJT2420E		19,184.00	1450
24 X 24	XDMJT2424E		19,471.00	1535
30 X 6	XDMJT3006E		20,682.00	1730
30 X 8	XDMJT3008E		20,869.00	1745
30 X 10	XDMJT3010E		21,043.00	1760
30 X 12	XDMJT3012E		21,280.00	1780
30 X 14	XDMJT3014E		30,555.00	1800
30 X 16	XDMJT3016E		30,907.00	1820
30 X 18	XDMJT3018E		22,061.00	1845
30 X 20	XDMJT3020E		22,419.00	1875
30 X 24	XDMJT3024E		28,689.00	2400
30 X 30	XDMJT3030E		31,023.00	2595
36 X 6	XDMJT3606E		29,888.00	2439
36 X 8	XDMJT3608E		30,127.00	2520
36 X 10	XDMJT3610E		31,208.00	2535
36 X 12	XDMJT3612E		30,489.00	2550
36 X 14	XDMJT3614E		30,727.00	2570
36 X 16	XDMJT3616E		26,129.00	2585
36 X 18	XDMJT3618E		31,208.00	2610
36 X 20	XDMJT3620E		31,504.00	2635
36 X 24	XDMJT3624E		32,160.00	2690
36 X 30	XDMJT3630E		42,383.00	3545
36 X 36	XDMJT3636E		36,175.00	3745
42 X 6	XDMJT4206E		74,580.00	3440
42 X 12	XDMJT4212E		44,875.00	3555
42 X 14	XDMJT4214E		45,130.00	3575
42 X 16	XDMJT4216E		45,381.00	3595
42 X 18	XDMJT4218E		78,644.00	3615

Contd.....

CALL FOR BARE/BARE FITTINGS

**TEES : MJ X MJ**

Contd.....

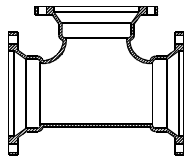

Size (in.)	Item No.	Crt. Qty.	List Price (\$)	Wt. (lb.)
42 X 20	XDMJT4220E		78,693.00	3640
42 X 24	XDMJT4224E		46,583.00	3690
42 X 30	XDMJT4230E		58,694.00	4650
42 X 36	XDMJT4236E		76,681.00	6075
42 X 42	XDMJT4242E		79,776.00	6320
48 X 12	XDMJT4812E		87,260.00	4870
48 X 14	XDMJT4814E		87,110.00	4885
48 X 16	XDMJT4816E		90,387.00	4905
48 X 18	XDMJT4818E		93,249.00	4925
48 X 20	XDMJT4820E		84,999.00	4950
48 X 24	XDMJT4824E		63,052.00	4995
48 X 30	XDMJT4830E		64,881.00	5140
48 X 36	XDMJT4836E		79,269.00	6280
48 X 42	XDMJT4842E		1,02,619.00	8130
48 X 36 X 48	XDMJT483648E		POA	6397
48 X 48	XDMJT4848E		1,06,278.00	8420

**TEES : MJ X PE X MJ**

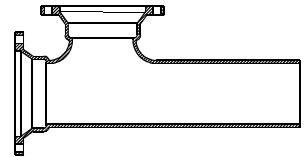

Size (in.)	Item No.	Crt. Qty.	List Price (\$)	Wt. (lb.)
4 X 4	XDMJPT0404E		POA	75
6 X 6	XDMJPT0606E		POA	120
8 X 4	XDMJPT0804E	6	2,160.00	160
8 X 6	XDMJPT0806E		POA	170
8 X 8	XDMJPT0808E		1,857.00	180
10 X 10	XDMJPT1010E		POA	250
12 X 4	XDMJPT1204E		POA	315
12 X 6	XDMJPT1206E		4,487.00	325
12 X 8	XDMJPT1208E		4,157.00	340
12 X 10	XDMJPT1210E		POA	390
12 X 12	XDMJPT1212E		5,114.00	410
14 X 14	XDMJPT1414E		6,332.00	500
16 X 8	XDMJPT1608E	2	6,182.00	530
16 X 16	XDMJPT1616E		7,890.00	625
24 X 6	XDMJPT2406E	2	15,061.00	945
24 X 8	XDMJPT2408E		15,408.00	960
24 X 12	XDMJPT2412E		15,706.00	990
24 X 16	XDMJPT2416E		16,327.00	1035
24 X 24	XDMJPT2424E		23,867.00	1490
36 X 12	XDMJPT3612E		42,066.00	2375
36 X 24	XDMJPT3624E		48,319.00	2515
36 X 36	XDMJPT3636E		68,229.00	3565

**MJ X SWIVEL HYDRANT TEE (W/SWIVEL GLAND)**

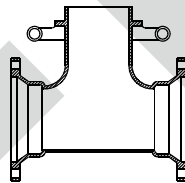

Size (in.)	Item No.	Crt. Qty.	List Price (\$)	Wt. (lb.)
6 X 6	XDMJTH0606E	9	1,358.00	145
8 X 6	XDMJTH0806E	9	1,710.00	165
8 X 8	XDMJTH0808E		2,834.00	210
10 X 6	XDMJTH1006E		2,833.00	270
12 X 6	XDMJTH1206E	4	3,598.00	365
12 X 8	XDMJTH1208E	4	6,223.00	350
16 X 6	XDMJTH1606E		6,076.00	619
16 X 8	XDMJTH1608E		POA	649
20 X 6	XDMJTH2006E	2	20,268.00	725
24 X 6	XDMJTH2406E		24,977.00	973
30 X 6	XDMJTH3006E		23,816.00	2070
36 X 6	XDMJTH3606E		30,127.00	2830

**TEES : MJ TAPPED 2"**

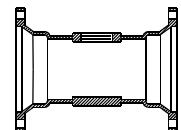

Size (in.)	Item No.	Crt. Qty.	List Price (\$)	Wt. (lb.)
4 X 4	XDMJX0404TE	0	538.00	45
6 X 6	XDMJX0606TE	0	791.00	70
8 X 8	XDMJX0808TE	0	1,223.00	95
10 X 10	XDMJX1010TE	0	1,408.00	130
12 X 12	XDMJX1212TE	0	1,772.00	165
16 X 16	XDMJX1616TE	0	3,048.00	274
18 X 18	XDMJX1818TE	0	5,054.00	305
20 X 20	XDMJX2020TE	0	5,742.00	352
24 X 24	XDMJX2424TE	0	7,130.00	496

CALL FOR BARE/BARE FITTINGS

**TEES : MJ X FE**

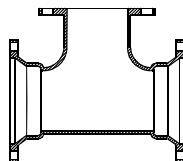

Size (in.)	Item No.	Crt. Qty.	List Price (\$)	Wt. (lb.)
3 X 3	XDMJFT0303E		POA	45
4 X 2	XDMJFT0402E		891.00	53
4 X 4	XDMJFT0404E		924.00	74
6 X 3	XDMJFT0603E		1,731.00	115
6 X 4	XDMJFT0604E		1,338.00	109
6 X 6	XDMJFT0606E	2	1,445.00	120
8 X 4	XDMJFT0804E		1,834.00	159
8 X 6	XDMJFT0806E	2	1,638.00	170
8 X 8	XDMJFT0808E	2	1,986.00	194
10 X 4	XDMJFT1004E		2,369.00	229
10 X 6	XDMJFT1006E	12	2,319.00	245
10 X 8	XDMJFT1008E		2,568.00	250
12 X 4	XDMJFT1204E	2	3,305.00	323
12 X 6	XDMJFT1206E	2	3,197.00	320
12 X 8	XDMJFT1208E	2	4,598.00	342
12 X 10	XDMJFT1210E		POA	372
12 X 12	XDMJFT1212E		POA	401
14 X 6	XDMJFT1406E		7,145.00	457
14 X 8	XDMJFT1408E		10,533.00	473
16 X 4	XDMJFT1604E		6,291.00	575
16 X 6	XDMJFT1606E		6,621.00	605
16 X 8	XDMJFT1608E		6,730.00	615
16 X 12	XDMJFT1612E		7,125.00	651
16 X 16	XDMJFT1616E		7,985.00	730
18 X 6	XDMJFT1806E		7,511.00	665
18 X 8	XDMJFT1808E		7,626.00	675
18 X 12	XDMJFT1812E		7,964.00	735
18 X 18	XDMJFT1818E		10,332.00	915
20 X 6	XDMJFT2006E		9,747.00	820
20 X 8	XDMJFT2008E		9,431.00	835
20 X 12	XDMJFT2012E		10,678.00	700
20 X 20	XDMJFT2020E		13,153.00	1165
24 X 6	XDMJFT2406E		12,706.00	1125
24 X 8	XDMJFT2408E		12,866.00	1140
24 X 12	XDMJFT2412E		13,153.00	1165
24 X 18	XDMJFT2418E		20,945.00	1349
24 X 24	XDMJFT2424E		20,263.00	1795
30 X 6	XDMJFT3006E		20,448.00	1800

Size (in.)	Item No.	Crt. Qty.	List Price (\$)	Wt. (lb.)
30 X 8	XDMJFT3008E		30,042.00	1725
30 X 30	XDMJFT3030E		POA	3080
36 X 6	XDMJFT3606E		29,752.00	2430
36 X 8	XDMJFT3608E		39,249.00	
36 X 12	XDMJFT3612E		30,489.00	2550
36 X 16	XDMJFT3616E		30,388.00	2450
36 X 24	XDMJFT3624E		41,832.00	2660
36 X 30	XDMJFT3630E		86,683.00	2964
36 X 36	XDMJFT3636E		87,743.00	3461
42 X 12	XDMJFT4212E		1,27,869.00	3547
42 X 16	XDMJFT4216E		1,28,867.00	3562
42 X 24	XDMJFT4224E		1,27,450.00	3527
48 X 24	XDMJFT4824E		POA	4965

**CROSSES : MJ X FE**

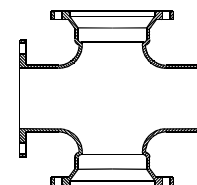

Size (in.)	Item No.	Crt. Qty.	List Price (\$)	Wt. (lb.)
6 X 6	XDMJFX0606E	0	POA	140
8 X 6	XDMJFX0806E	0	POA	185
8 X 8	XDMJFX0808E	0	POA	240
10 X 10	XDMJFX1010E	0	POA	354
12 X 6	XDMJFX1206E	0	POA	340
12 X 8	XDMJFX1208E	0	POA	365
12 X 12	XDMJFX1212E	0	POA	487
16 X 8	XDMJFX1608E	0	POA	655
16 X 16	XDMJFX1616E	0	POA	875

**CALL FOR BARE/BARE FITTINGS**

**CROSSES : MJ X MJ**

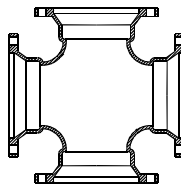

Size (in.)	Item No.	Crt. Qty.	List Price (\$)	Wt. (lb.)
4 X 4	XDMJX0404E		1,090.00	105
6 X 4	XDMJX0604E		1,445.00	142
6 X 6	XDMJX0606E	8	1,587.00	160
8 X 4	XDMJX0804E		1,913.00	185
8 X 6	XDMJX0806E		2,117.00	205
8 X 8	XDMJX0808E	4	2,335.00	235
10 X 6	XDMJX1006E		2,939.00	285
10 X 8	XDMJX1008E		3,192.00	310
10 X 10	XDMJX1010E		3,913.00	380
12 X 4	XDMJX1204E		4,224.00	340
12 X 6	XDMJX1206E		3,708.00	360
12 X 8	XDMJX1208E	2	3,915.00	385
12 X 12	XDMJX1212E	2	5,028.00	495
14 X 8	XDMJX1408E		4,921.00	500
14 X 14	XDMJX1414E		6,948.00	635
16 X 6	XDMJX1606E		6,291.00	575
16 X 8	XDMJX1608E		6,621.00	605
16 X 12	XDMJX1612E		12,108.00	685
16 X 16	XDMJX1616E		8,638.00	790
18 X 8	XDMJX1808E		7,184.00	655
18 X 10	XDMJX1810E		7,736.00	685
18 X 12	XDMJX1812E		8,188.00	725
18 X 18	XDMJX1818E		11,237.00	995
20 X 8	XDMJX2008E		8,810.00	790
20 X 12	XDMJX2012E		9,713.00	860
20 X 16	XDMJX2016E		12,253.00	1085
20 X 20	XDMJX2020E		13,884.00	1230
24 X 6	XDMJX2406E		11,439.00	1025
24 X 8	XDMJX2408E		11,801.00	1045
24 X 12	XDMJX2412E		12,522.00	1110
24 X 16	XDMJX2416E		13,553.00	1200
24 X 20	XDMJX2420E		18,909.00	1675
24 X 24	XDMJX2424E		20,715.00	1835
30 X 6	XDMJX3006E		21,164.00	1770
30 X 12	XDMJX3012E		22,302.00	1865
30 X 16	XDMJX3016E		38,800.00	1968
30 X 24	XDMJX3024E		31,982.00	2675
30 X 30	XDMJX3030E		36,764.00	3075
36 X 12	XDMJX3612E		31,442.00	2645

Size (in.)	Item No.	Crt. Qty.	List Price (\$)	Wt. (lb.)
36 X 16	XDMJX3616E		50,612.00	2718
36 X 20	XDMJX3620E		51,686.00	2815
36 X 24	XDMJX3624E		47,427.00	2910
36 X 30	XDMJX3630E		64,604.00	3978
36 X 36	XDMJX3636E		52,241.00	4370
42 X 24	XDMJX4224E		1,18,297.00	3924
42 X 30	XDMJX4230E		1,49,567.00	5039
42 X 36	XDMJX4236E		1,81,849.00	5428
42 X 42	XDMJX4242E		1,96,547.00	7145
48 X 24	XDMJX4824E		81,525.00	5225
48 X 30	XDMJX4830E		85,828.00	5510
48 X 36	XDMJX4836E		85,707.00	6795
48 X 42	XDMJX4842E		1,22,560.00	8827
48 X 48	XDMJX4848E		1,53,975.00	9400

**MJ 45° LATERAL (WYES)**

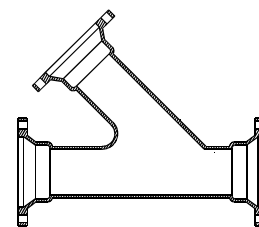

Size (in.)	Item No.	Crt. Qty.	List Price (\$)	Wt. (lb.)
3 X 3	XDMJL0303E		622.00	60
4 X 3	XDMJL0403E		1,042.00	
4 X 4	XDMJL0404E		931.00	90
6 X 4	XDMJL0604E	12	1,395.00	130
6 X 6	XDMJL0606E	4	1,739.00	145
8 X 4	XDMJL0804E		1,961.00	190
8 X 6	XDMJL0806E	4	2,117.00	205
8 X 8	XDMJL0808E	4	2,172.00	230
10 X 4	XDMJL1004E		4,566.00	274
10 X 6	XDMJL1006E		2,939.00	285
10 X 8	XDMJL1008E		3,146.00	310
10 X 10	XDMJL1010E		3,864.00	340
12 X 4	XDMJL1204E		4,286.00	382
12 X 6	XDMJL1206E		4,913.00	396
12 X 8	XDMJL1208E		4,377.00	425

CALL FOR BARE/BARE FITTINGS

Contd.....

**MJ 45° LATERAL (WYES)** Contd.....

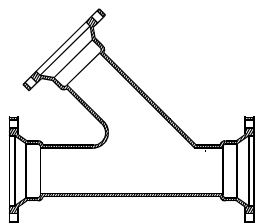

Size (in.)	Item No.	Crt. Qty.	List Price (\$)	Wt. (lb.)
12 X 10	XDMJL1210E		6,301.00	512
12 X 12	XDMJL1212E		5,508.00	535
14 X 6	XDMJL1406E		6,183.00	615
14 X 8	XDMJL1408E		6,957.00	630
14 X 12	XDMJL1412E		9,728.00	652
14 X 14	XDMJL1414E		8,261.00	725
16 X 6	XDMJL1606E		8,421.00	770
16 X 8	XDMJL1608E		8,696.00	795
16 X 10	XDMJL1610E		9,078.00	835
16 X 12	XDMJL1612E		9,515.00	872
16 X 16	XDMJL1616E		9,733.00	1079
18 X 6	XDMJL1806E		8,244.00	752
18 X 8	XDMJL1808E		10,758.00	968
18 X 10	XDMJL1810E		12,080.00	975
18 X 12	XDMJL1812E		12,758.00	1015
18 X 16	XDMJL1816E		12,981.00	1135
18 X 18	XDMJL1818E		13,548.00	1200
20 X 06	XDMJL2006E		16,880.00	872
20 X 08	XDMJL2008E		17,954.00	689
20 X 10	XDMJL2010E		14,142.00	1220
20 X 12	XDMJL2012E		13,569.00	1260
20 X 14	XDMJL2014E		22,592.00	1368
20 X 16	XDMJL2016E		13,189.00	1375
20 X 20	XDMJL2020E		17,219.00	1525
24 X 6	XDMJL2406E		25,612.00	1874
24 X 8	XDMJL2408E		28,731.00	1882
24 X 12	XDMJL2412E		33,610.00	1388
24 X 16	XDMJL2416E		36,432.00	1827
24 X 18	XDMJL2418E		38,764.00	2075
24 X 20	XDMJL2420E		32,763.00	2148
24 X 24	XDMJL2424E		25,341.00	2372
30 X 12	XDMJL3012E		52,894.00	3125
30 X 16	XDMJL3016E		45,622.00	3264
30 X 18	XDMJL3018E		46,394.00	2995
30 X 20	XDMJL3020E		41,978.00	3418
30 X 24	XDMJL3024E		44,158.00	3292
30 X 30	XDMJL3030E		43,876.00	3670
36 X 12	XDMJL3612E		74,066.00	4695
36 X 16	XDMJL3616E		67,384.00	5050

Size (in.)	Item No.	Crt. Qty.	List Price (\$)	Wt. (lb.)
36 X 18	XDMJL3618E		71,447.00	5025
36 X 20	XDMJL3620E		62,860.00	5090
36 X 24	XDMJL3624E		62,979.00	5851
36 X 30	XDMJL3630E		69,330.00	5815
36 X 36	XDMJL3636E		83,380.00	6900
42 X 24	XDMJL4224E		85,957.00	6810
42 X 30	XDMJL4230E		91,005.00	7280
42 X 36	XDMJL4236E		1,05,461.00	8355
42 X 42	XDMJL4242E		1,33,387.00	9915
48 X 20	XDMJL4820E		1,24,384.00	6554
48 X 24	XDMJL4824E		POA	
48 X 30	XDMJL4830E		1,30,498.00	6574
48 X 48	XDMJL4848E		1,42,415.00	11892

**MJ X PE OFFSET**

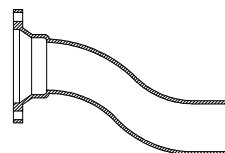

Size (in.)	Item No.	Crt. Qty.	List Price (\$)	Wt. (lb.)
4 X 6	XDMJOP0406E		1,173.00	70
4 X 12	XDMJOP0412E		1,195.00	80
4 X 24	XDMJOP0424E		1,609.00	125
6 X 6	XDMJOP0606E		1,445.00	105
6 X 12	XDMJOP0612E		1,343.00	130
6 X 18	XDMJOP0618E		1,577.00	160
6 X 24	XDMJOP0624E		1,559.00	160
8 X 6	XDMJOP0806E		2,620.00	155
8 X 12	XDMJOP0812E		2,136.00	195
8 X 18	XDMJOP0818E		3,956.00	240
8 X 24	XDMJOP0824E		3,068.00	285
10 X 12	XDMJOP1012E		POA	280
10 X 18	XDMJOP1018E		POA	340
12 X 06	XDMJOP1206E		4,419.00	328
12 X 12	XDMJOP1212E		7,411.00	420
12 X 18	XDMJOP1218E	2	POA	520
12 X 24	XDMJOP1224E		POA	630
16 X 18	XDMJOP1618E		POA	690

CALL FOR BARE/BARE FITTINGS

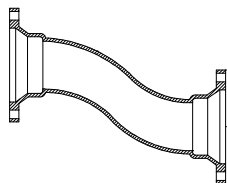
**MJ OFFSET**

Size (in.)	Item No.	Crt. Qty.	List Price (\$)	Wt. (lb.)
4 X 6	XDMJO0406E	0	POA	75
4 X 12	XDMJO0412E	0	886.00	85
4 X 18	XDMJO0418E	0	1,090.00	105
4 X 24	XDMJO0424E	0	1,294.00	126
6 X 6	XDMJO0606E	0	1,138.00	114
6 X 12	XDMJO0612E	0	1,395.00	135
6 X 18	XDMJO0618E	0	1,706.00	188
6 X 24	XDMJO0624E	0	1,597.00	182
8 X 6	XDMJO0806E	0	1,651.00	177
8 X 12	XDMJO0812E	0	2,060.00	231
8 X 18	XDMJO0818E	0	2,518.00	287
8 X 24	XDMJO0824E	0	2,634.00	280
10 X 12	XDMJO1012E	0	3,447.00	347
10 X 18	XDMJO1018E	0	3,500.00	340
10 X 24	XDMJO1024E	0	4,321.00	420
12 X 6	XDMJO1206E	0	6,842.00	345
12 X 12	XDMJO1212E	0	4,321.00	420
12 X 18	XDMJO1218E	0	5,353.00	520
12 X 24	XDMJO1224E	0	6,587.00	649
16 X 12	XDMJO1612E	0	7,080.00	715
16 X 18	XDMJO1618E	0	7,597.00	850
20 X 12	XDMJO2012E	0	8,188.00	1025
20 X 18	XDMJO2018E	0	13,434.00	1246
20 X 24	XDMJO2024E	0	28,765.00	1362

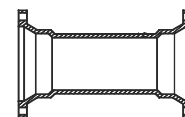
**MJ LONG SLEEVES**

Size (in.)	Item No.	Crt. Qty.	List Price (\$)	Wt. (lb.)
2	XDMJSL02E	0	319.00	18
3	XDMJSL03E	0	317.00	30
4	XDMJSL04E	24	406.00	45
6	XDMJSL06E	27	584.00	65
8	XDMJSL08E	27	738.00	85
10	XDMJSL10E	12	1,195.00	115
12	XDMJSL12E	12	1,385.00	145
14	XDMJSL14E	2	2,137.00	195
16	XDMJSL16E	2	2,538.00	235
18	XDMJSL18E	0	3,569.00	285
20	XDMJSL20E	2	3,629.00	325
24	XDMJSL24E	0	4,769.00	425
30	XDMJSL30E	0	11,042.00	1088
36	XDMJSL36E	0	14,913.00	1052
42	XDMJSL42E	0	16,664.00	1550
48	XDMJSL48E	0	26,548.00	1940

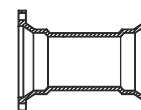
**MJ SHORT SLEEVES**

Size (in.)	Item No.	Crt. Qty.	List Price (\$)	Wt. (lb.)
2	XDMJSS02E	48	186.00	12
3	XDMJSS03E		407.00	25
4	XDMJSS04E	4	356.00	35
6	XDMJSS06E	4	408.00	45
8	XDMJSS08E	27	584.00	65
10	XDMJSS10E	4	859.00	85
12	XDMJSS12E	12	1,122.00	110
14	XDMJSS14E		2,501.00	150
16	XDMJSS16E		1,909.00	180
18	XDMJSS18E		2,433.00	215
20	XDMJSS20E		2,714.00	240
24	XDMJSS24E		4,190.00	320
30	XDMJSS30E		9,022.00	635
36	XDMJSS36E		12,315.00	855
42	XDMJSS42E		14,081.00	1115
48	XDMJSS48E		21,154.00	1385

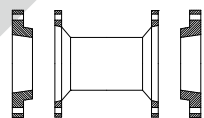
**MJ DUAL PURPOSE SLEEVES**

Size (in.)	Item No.	Crt. Qty.	List Price (\$)	Wt. (lb.)
4	XDMJSSDP04E	24	POA	35
6	XDMJSSDP06E	18	POA	45
8	XDMJSSDP08E	0	POA	65

CALL FOR BARE/BARE FITTINGS

**REDUCERS : MJ X MJ**

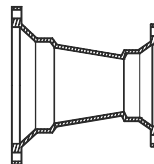

Size (in.)	Item No.	Crt. Qty.	List Price (\$)	Wt. (lb.)
3 X 2	XDMJR0302E	60	314.00	26
4 X 2	XDMJR0402E	48	327.00	30
4 X 3	XDMJR0403E	48	401.00	40
6 X 2	XDMJR0602E	24	477.00	45
6 X 3	XDMJR0603E	24	554.00	55
6 X 4	XDMJR0604E	24	538.00	60
8 X 3	XDMJR0803E		964.00	84
8 X 4	XDMJR0804E	16	859.00	80
8 X 6	XDMJR0806E	16	847.00	95
10 X 4	XDMJR1004E		1,451.00	105
10 X 6	XDMJR1006E	12	1,161.00	115
10 X 8	XDMJR1008E	12	1,362.00	135
12 X 4	XDMJR1204E	8	1,471.00	135
12 X 6	XDMJR1206E	8	1,807.00	150
12 X 8	XDMJR1208E	8	1,701.00	165
12 X 10	XDMJR1210E	8	1,922.00	190
14 X 6	XDMJR1406E	4	1,895.00	190
14 X 8	XDMJR1408E		2,303.00	214
14 X 10	XDMJR1410E		2,519.00	236
14 X 12	XDMJR1412E	2	2,800.00	255
16 X 6	XDMJR1606E		2,519.00	230
16 X 8	XDMJR1608E		3,355.00	250
16 X 10	XDMJR1610E		3,052.00	280
16 X 12	XDMJR1612E		3,664.00	305
16 X 14	XDMJR1614E		3,669.00	335
18 X 8	XDMJR1808E		3,337.00	295
18 X 10	XDMJR1810E		3,677.00	325
18 X 12	XDMJR1812E		3,956.00	350
18 X 14	XDMJR1814E		4,296.00	380
18 X 16	XDMJR1816E		4,692.00	415
20 X 8	XDMJR2008E		7,519.00	345
20 X 10	XDMJR2010E		4,190.00	375
20 X 12	XDMJR2012E		4,580.00	405
20 X 14	XDMJR2014E		6,612.00	435
20 X 16	XDMJR2016E		5,310.00	470
20 X 18	XDMJR2018E		5,762.00	510
24 X 12	XDMJR2412E		6,210.00	550
24 X 16	XDMJR2416E		6,950.00	615
24 X 18	XDMJR2418E		7,453.00	660

Size (in.)	Item No.	Crt. Qty.	List Price (\$)	Wt. (lb.)
24 X 20	XDMJR2420E		7,964.00	705
30 X 12	XDMJR3012E		12,096.00	920
30 X 16	XDMJR3016E		11,783.00	985
30 X 18	XDMJR3018E		11,840.00	990
30 X 20	XDMJR3020E		12,560.00	1050
30 X 24	XDMJR3024E		13,933.00	1165
36 X 20	XDMJR3620E		17,341.00	1450
36 X 24	XDMJR3624E		18,890.00	1580
36 X 30	XDMJR3630E		22,182.00	1855
42 X 20	XDMJR4220E		24,178.00	1928
42 X 24	XDMJR4224E		26,002.00	2060
42 X 30	XDMJR4230E		29,919.00	2370
42 X 36	XDMJR4236E		34,024.00	2714
48 X 30	XDMJR4830E		37,936.00	3005
48 X 36	XDMJR4836E		42,542.00	3385
48 X 42	XDMJR4842E		47,335.00	3776

**REDUCERS : FE X MJ**

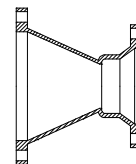

Size (in.)	Item No.	Crt. Qty.	List Price (\$)	Wt. (lb.)
4 X 3	FXDMJR0403E	0	349.00	34
6 X 4	FXDMJR0604E	0	527.00	60
8 X 4	FXDMJR0804E	0	717.00	80
8 X 6	FXDMJR0806E	0	866.00	89
10 X 6	FXDMJR1006E	0	1,136.00	114
10 X 8	FXDMJR1008E	0	1,254.00	130
12 X 6	FXDMJR1206E	0	1,407.00	151
12 X 8	FXDMJR1208E	0	1,658.00	183
12 X 10	FXDMJR1210E	0	1,808.00	190
16 X 12	FXDMJR1612E	0	3,068.00	305

**CALL FOR BARE/BARE FITTINGS**

**REDUCERS : MJ  
SMALL END (SEB)**

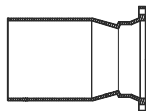

**REDUCERS : MJ X FE**

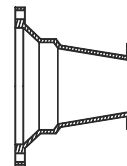

Size (in.)	Item No.	Crt. Qty.	List Price (\$)	Wt. (lb.)
3 X 2	XDMJRS0302E	48	431.00	14
4 X 2	XDMJRS0402E	48	370.00	18
4 X 3	XDMJRS0403E		365.00	35
6 X 2	XDMJRS0602E	26	501.00	45
6 X 3	XDMJRS0603E		521.00	50
6 X 4	XDMJRS0604E		622.00	60
8 X 3	XDMJRS0803E		791.00	77
8 X 4	XDMJRS0804E	16	829.00	80
8 X 6	XDMJRS0806E	16	931.00	90
10 X 6	XDMJRS1006E		1,188.00	115
10 X 8	XDMJRS1008E		1,343.00	130
12 X 4	XDMJRS1204E		1,343.00	130
12 X 6	XDMJRS1206E		1,547.00	150
12 X 8	XDMJRS1208E	12	1,706.00	165
12 X 10	XDMJRS1210E		1,961.00	190
16 X 8	XDMJRS1608E		2,519.00	230
16 X 12	XDMJRS1612E		3,122.00	285
16 X 14	XDMJRS1614E		5,718.00	310
18 X 12	XDMJRS1812E		3,677.00	325
20 X 8	XDMJRS2008E		7,358.00	345
20 X 12	XDMJRS2012E		4,241.00	375
20 X 16	XDMJRS2016E		4,914.00	435
20 X 18	XDMJRS2018E		7,358.00	345
24 X 12	XDMJRS2412E		5,762.00	510
24 X 14	XDMJRS2414E		9,418.00	535
24 X 16	XDMJRS2416E		6,497.00	575
24 X 18	XDMJRS2418E		7,002.00	620
24 X 20	XDMJRS2420E		7,511.00	665
30 X 16	XDMJRS3016E		10,760.00	900
30 X 18	XDMJRS3018E		10,587.00	885
30 X 20	XDMJRS3020E		11,304.00	945
30 X 24	XDMJRS3024E		12,675.00	1060
36 X 20	XDMJRS3620E		24,828.00	1285
36 X 24	XDMJRS3624E		28,048.00	1410
36 X 30	XDMJRS3630E		20,210.00	1690
42 X 30	XDMJRS4230E		38,911.00	2165
42 X 36	XDMJRS4236E		41,890.00	2485
48 X 36	XDMJRS4836E		39,129.00	3100

Size (in.)	Item No.	Crt. Qty.	List Price (\$)	Wt. (lb.)
4 X 3	XDMJFR0403E	0	361.00	35
6 X 3	XDMJFR0603E	0	544.00	49
6 X 4	XDMJFR0604E	0	571.00	54
8 X 4	XDMJFR0804E	0	771.00	75
8 X 6	XDMJFR0806E	2	840.00	80
10 X 6	XDMJFR1006E	0	973.00	105
10 X 8	XDMJFR1008E	0	1,254.00	130
12 X 6	XDMJFR1206E	0	1,282.00	145
12 X 8	XDMJFR1208E	0	1,801.00	175
12 X 10	XDMJFR1210E	0	1,781.00	185
14 X 6	XDMJFR1406E	0	1,960.00	195
14 X 8	XDMJFR1408E	0	2,363.00	215
14 X 12	XDMJFR1412E	0	2,466.00	270
16 X 12	XDMJFR1612E	0	3,714.00	325
18 X 8	XDMJFR1808E	0	3,392.00	300
18 X 12	XDMJFR1812E	0	4,491.00	360
18 X 16	XDMJFR1816E	0	5,028.00	445
20 X 16	XDMJFR2016E	0	5,762.00	510
24 X 12	XDMJFR2412E	0	7,472.00	455

**REDUCERS : MJ  
LARGE END (LEB)**

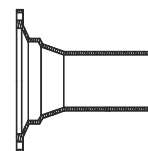

Size (in.)	Item No.	Crt. Qty.	List Price (\$)	Wt. (lb.)
4 X 3	XDMJRL0403E		414.00	40
6 X 3	XDMJRL0603E		571.00	55
6 X 4	XDMJRL0604E		622.00	60
8 X 3	XDMJRL0803E		777.00	70
8 X 4	XDMJRL0804E		829.00	80
8 X 6	XDMJRL0806E		1,016.00	98
10 X 6	XDMJRL1006E		1,188.00	115
10 X 8	XDMJRL1008E		1,343.00	130
12 X 4	XDMJRL1204E		1,879.00	135
12 X 6	XDMJRL1206E		1,498.00	145
12 X 8	XDMJRL1208E		1,706.00	165
12 X 10	XDMJRL1210E		1,913.00	185

CALL FOR BARE/BARE FITTINGS

Contd.....



**REDUCERS : MJ  
LARGE END (LEB)**

Contd.....

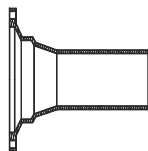

Size (in.)	Item No.	Crt. Qty.	List Price (\$)	Wt. (lb.)
16 X 8	XDMJRL1608E		4,328.00	
16 X 10	XDMJRL1610E		4,699.00	
16 X 12	XDMJRL1612E		3,341.00	305
20 X 10	XDMJRL2010E		5,768.00	375
20 X 16	XDMJRL2016E		5,028.00	445
24 X 16	XDMJRL2416E		6,722.00	595
24 X 20	XDMJRL2420E		7,626.00	675
30 X 16	XDMJRL3016E		15,850.00	910
30 X 18	XDMJRL3018E		16,112.00	965
30 X 20	XDMJRL3020E		12,198.00	1020
30 X 24	XDMJRL3024E		13,455.00	1125
36 X 20	XDMJRL3620E		16,979.00	1420
36 X 24	XDMJRL3624E		18,357.00	1535
36 X 30	XDMJRL3630E		20,127.00	1750
42 X 30	XDMJRL4230E		42,202.00	2265
42 X 36	XDMJRL4236E		46,813.00	2530
48 X 42	XDMJRL4842E		77,790.00	3540

**ADAPTERS : MJ X FLANGE**

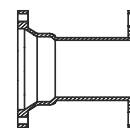

Size (in.)	Item No.	Crt. Qty.	List Price (\$)	Wt. (lb.)
3	XDMJFA03E		317.00	30
4	XDMJFA04E	16	414.00	40
6	XDMJFA06E	8	622.00	60
8	XDMJFA08E	8	886.00	85
10	XDMJFA10E		1,408.00	115
12	XDMJFA12E		1,771.00	155
14	XDMJFA14E	4	2,137.00	195
16	XDMJFA16E		2,848.00	240
18	XDMJFA18E		3,426.00	280
20	XDMJFA20E		4,128.00	340
24	XDMJFA24E		5,173.00	455
30	XDMJFA30E		9,089.00	760
36	XDMJFA36E		12,797.00	1070
42	XDMJFA42E		19,003.00	1505
48	XDMJFA48E		24,498.00	1942

**HYDRANT ADAPTERS :  
SWIVEL X SOLID  
WITH SWIVEL GLAND  
(ANCHOR COUPLING)**

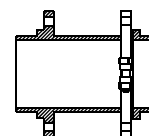

**HYDRANT ELL :  
SWIVEL X SWIVEL  
WITH TWO-SWIVEL GLAND**

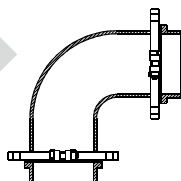

Size (in.)	Item No.	Crt. Qty.	List Price (\$)	Wt. (lb.)
6	XDMJHB9006E	0	POA	87
8	XDMJHB9008E	0	POA	158

Size (in.)	Item No.	Crt. Qty.	List Price (\$)	Wt. (lb.)
4 X 13	XDMJHA0413E	60	POA	28
6 X 13	XDMJHA0613E		POA	54
6 X 18	XDMJHA0618E		POA	68
6 X 24	XDMJHA0624E		POA	81
6 X 36	XDMJHA0636E		POA	110
6 X 48	XDMJHA0648E		POA	139
8 X 13	XDMJHA0813E	27	POA	68
8 X 18	XDMJHA0818E		POA	88
8 X 24	XDMJHA0824E		POA	112
8 X 48	XDMJHA0848E		POA	208
12 X 13	XDMJHA1213E	12	POA	123

CALL FOR BARE/BARE FITTINGS

**MJ CAPS : SOLID**



Size (in.)	Item No.	Crt. Qty.	List Price (\$)	Wt. (lb.)
2	XDMJC02E	100	99.00	5
3	XDMJC03E	50	126.00	12
4	XDMJC04E	18	156.00	20
6	XDMJC06E	18	232.00	30
8	XDMJC08E	18	395.00	45
10	XDMJC10E	8	609.00	60
12	XDMJC12E	8	817.00	80
14	XDMJC14E	2	1,558.00	110
16	XDMJC16E	2	1,645.00	155
18	XDMJC18E	2	1,959.00	185
20	XDMJC20E	2	2,682.00	200
24	XDMJC24E	2	3,901.00	300
30	XDMJC30E	0	7,062.00	590
36	XDMJC36E	0	10,169.00	815
42	XDMJC42E	0	14,896.00	1180
48	XDMJC48E	0	20,138.00	1595

**MJ CAPS : 2" TAPPED**



Size (in.)	Item No.	Crt. Qty.	List Price (\$)	Wt. (lb.)
2	XDMJC02TE	0	164.00	5
3	XDMJC03TE	0	192.00	12
4	XDMJC04TE	0	211.00	20
6	XDMJC06TE	18	305.00	30
8	XDMJC08TE	18	474.00	45
10	XDMJC10TE	0	672.00	60
12	XDMJC12TE	8	880.00	80
14	XDMJC14TE	0	1,660.00	110
16	XDMJC16TE	0	1,759.00	155
18	XDMJC18TE	0	1,976.00	185
20	XDMJC20TE	0	2,598.00	200
24	XDMJC24TE	0	3,690.00	300
30	XDMJC30TE	0	7,259.00	590
36	XDMJC36TE	0	10,369.00	815
42	XDMJC42TE	0	15,033.00	1180
48	XDMJC48TE	0	20,406.00	1595

**MJ PLUGS : SOLID**



Size (in.)	Item No.	Crt. Qty.	List Price (\$)	Wt. (lb.)
2	XDMJP02E	24	97.00	5
3	XDMJP03E	0	106.00	10
4	XDMJP04E	18	156.00	20
6	XDMJP06E	18	255.00	30
8	XDMJP08E	12	455.00	50
10	XDMJP10E	8	659.00	65
12	XDMJP12E	8	871.00	85
14	XDMJP14E	0	1,264.00	115
16	XDMJP16E	2	1,580.00	145
18	XDMJP18E	0	1,538.00	180
20	XDMJP20E	0	2,682.00	200
24	XDMJP24E	0	3,893.00	290
30	XDMJP30E	0	6,880.00	575
36	XDMJP36E	0	9,747.00	815
42	XDMJP42E	0	14,016.00	1110
48	XDMJP48E	0	18,371.00	1455

**MJ PLUGS : 2" TAPPED**



Size (in.)	Item No.	Crt. Qty.	List Price (\$)	Wt. (lb.)
2	XDMJP02TE		160.00	
3	XDMJP03TE	0	168.00	10
4	XDMJP04TE	18	211.00	20
6	XDMJP06TE	120	305.00	30
8	XDMJP08TE	100	481.00	50
10	XDMJP10TE	8	671.00	65
12	XDMJP12TE	40	860.00	85
14	XDMJP14TE	0	1,370.00	115
16	XDMJP16TE	0	1,668.00	145
18	XDMJP18TE	0	1,490.00	180
20	XDMJP20TE	0	2,615.00	200
24	XDMJP24TE	0	3,924.00	290
30	XDMJP30TE	0	6,658.00	575
36	XDMJP36TE	0	9,949.00	815
42	XDMJP42TE	0	15,693.00	1110
48	XDMJP48TE	0	20,885.00	1455

CALL FOR BARE/BARE FITTINGS

# Utility Pipe Fittings Fusion Bonded Epoxy

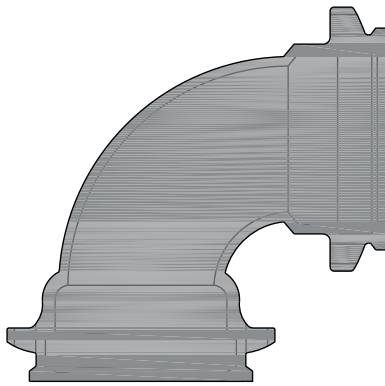

ANSI/AWWA C153/A21.53  
**COMPACT PUSH-ON FITTINGS**  

---

**FUSION BONDED EPOXY**

## PRICE LIST

**Effective December 16, 2024**



**BENDS : PO X PO  
90° (1/4)**

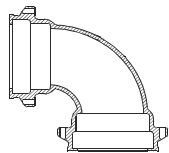

Size (in.)	Item No.	Crt. Qty.	List Price (\$)	Wt. (lb.)
4	CDPOB9004E	60	350.00	28
6	CDPOB9006E	32	558.00	44
8	CDPOB9008E	18	826.00	71
10	CDPOB9010E	12	1,082.00	100
12	CDPOB9012E	6	1,788.00	140
14	CDPOB9014E	0	2,599.00	254
16	CDPOB9016E	4	4,644.00	280
18	CDPOB9018E	0	6,289.00	482
20	CDPOB9020E	0	7,038.00	640
24	CDPOB9024E	2	8,785.00	710

**BENDS : PO X PO  
45° (1/8)**

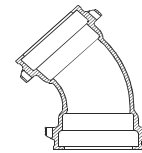

Size (in.)	Item No.	Crt. Qty.	List Price (\$)	Wt. (lb.)
4	CDPOB4504E	75	319.00	23
6	CDPOB4506E	36	474.00	38
8	CDPOB4508E	27	691.00	54
10	CDPOB4510E	18	1,033.00	84
12	CDPOB4512E	8	1,377.00	110
14	CDPOB4514E		2,060.00	150
16	CDPOB4516E	4	3,250.00	210
18	CDPOB4518E		3,664.00	309
20	CDPOB4520E		5,176.00	397
24	CDPOB4524E		6,416.00	455

**BENDS : PO X PO  
22½° (1/16)**

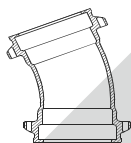

Size (in.)	Item No.	Crt. Qty.	List Price (\$)	Wt. (lb.)
4	CDPOB2204E	75	305.00	22
6	CDPOB2206E	48	421.00	34
8	CDPOB2208E	27	588.00	55
10	CDPOB2210E	18	874.00	70
12	CDPOB2212E	8	1,170.00	90
14	CDPOB2214E		2,060.00	162
16	CDPOB2216E	4	3,026.00	220
18	CDPOB2218E		4,000.00	209
20	CDPOB2220E		5,402.00	414
24	CDPOB2224E		7,364.00	455

**BENDS : PO X PO  
11¼° (1/32)**

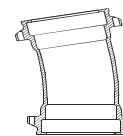

Size (in.)	Item No.	Crt. Qty.	List Price (\$)	Wt. (lb.)
4	CDPOB1104E	75	300.00	21
6	CDPOB1106E	48	413.00	32
8	CDPOB1108E	25	576.00	52
10	CDPOB1110E	18	851.00	70
12	CDPOB1112E	8	1,132.00	95
14	CDPOB1114E		2,060.00	113
16	CDPOB1116E	4	3,064.00	170
18	CDPOB1118E		4,023.00	209
20	CDPOB1120E		4,900.00	265
24	CDPOB1124E	2	9,745.00	315

**BENDS : PO X PE  
90° (1/4)**

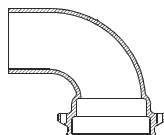

Size (in.)	Item No.	Crt. Qty.	List Price (\$)	Wt. (lb.)
4	CDPOPB9004E	60	637.00	24
6	CDPOPB9006E	32	604.00	48
8	CDPOPB9008E		POA	

**BENDS : PO X PE  
45° (1/8)**

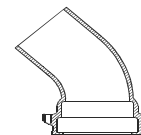

Size (in.)	Item No.	Crt. Qty.	List Price (\$)	Wt. (lb.)
4	CDPOPB4504E	75	232.00	21
6	CDPOPB4506E	36	489.00	38
8	CDPOPB4508E	27	764.00	60

CALL FOR BARE/BARE FITTINGS

**BENDS : PO X PE**  
**22½° (1/16)**

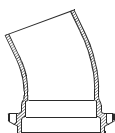

Size (in.)	Item No.	Crt. Qty.	List Price (\$)	Wt. (lb.)
4	CDPOPB2204E		POA	
6	CDPOPB2206E	48	450.00	35
8	CDPOPB2208E	27	726.00	57

**BENDS : PO X PE**  
**11¼° (1/32)**

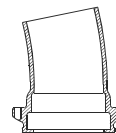

Size (in.)	Item No.	Crt. Qty.	List Price (\$)	Wt. (lb.)
4	CDPOPB1104E		POA	
6	CDPOPB1106E	48	461.00	35
8	CDPOPB1108E	27	703.00	55

**BENDS : PO X FE**  
**90° (1/4)**

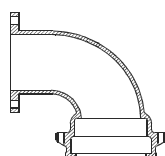

Size (in.)	Item No.	Crt. Qty.	List Price (\$)	Wt. (lb.)
4	CDPOFB9004E	24	308.00	32
6	CDPOFB9006E	36	774.00	49
8	CDPOFB9008E	18	874.00	74
10	CDPOFB9010E	16	1,451.00	130
12	CDPOFB9012E	16	2,190.00	158
14	CDPOFB9014E	0	2,014.00	231
16	CDPOFB9016E	4	2,944.00	233

**BENDS : PO X FE**  
**45° (1/8)**

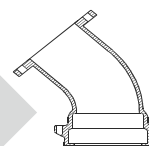

Size (in.)	Item No.	Crt. Qty.	List Price (\$)	Wt. (lb.)
4	CDPOFB4504E	0	274.00	21
6	CDPOFB4506E	36	595.00	42
8	CDPOFB4508E	18	912.00	60
10	CDPOFB4510E	0	1,181.00	93
12	CDPOFB4512E	0	1,701.00	122
14	CDPOFB4514E	0	2,052.00	162
16	CDPOFB4516E	0	3,479.00	275

**BENDS : PO X FE**  
**22½° (1/16)**

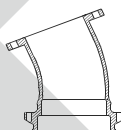

Size (in.)	Item No.	Crt. Qty.	List Price (\$)	Wt. (lb.)
4	CDPOFB2204E	48	342.00	25
6	CDPOFB2206E	36	447.00	44
8	CDPOFB2208E	24	740.00	64
10	CDPOFB2210E	12	1,041.00	90
12	CDPOFB2212E	8	1,688.00	112
14	CDPOFB2214E		2,052.00	174
16	CDPOFB2216E		3,479.00	228

**BENDS : PO X FE**  
**11¼° (1/32)**

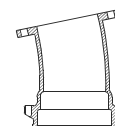

Size (in.)	Item No.	Crt. Qty.	List Price (\$)	Wt. (lb.)
4	CDPOFB1104E	48	308.00	24
6	CDPOFB1106E	36	447.00	30
8	CDPOFB1108E	27	746.00	60
10	CDPOFB1110E	12	975.00	80
12	CDPOFB1112E	8	1,451.00	96
14	CDPOFB1114E		2,154.00	170
16	CDPOFB1116E		2,887.00	230

**CALL FOR BARE/BARE FITTINGS**

**TEES : PO X PO**

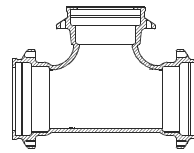

Size (in.)	Item No.	Crt. Qty.	List Price (\$)	Wt. (lb.)
4 X 4	CDPOT0404E	48	496.00	46
6 X 4	CDPOT0604E	24	628.00	58
6 X 6	CDPOT0606E	24	698.00	66
8 X 4	CDPOT0804E	16	841.00	93
8 X 6	CDPOT0806E	18	954.00	103
8 X 8	CDPOT0808E	18	1,136.00	109
10 X 4	CDPOT1004E	18	1,287.00	95
10 X 6	CDPOT1006E	12	1,408.00	129
10 X 8	CDPOT1008E	8	1,653.00	141
10 X 10	CDPOT1010E	8	2,052.00	145
12 X 4	CDPOT1204E	12	1,597.00	115
12 X 6	CDPOT1206E	8	1,495.00	164
12 X 8	CDPOT1208E	8	1,817.00	166
12 X 10	CDPOT1210E	4	2,071.00	175
12 X 12	CDPOT1212E	4	2,052.00	193
14 X 6	CDPOT1406E		2,023.00	176
14 X 10	CDPOT1410E		4,105.00	195
14 X 12	CDPOT1412E		4,160.00	196
14 X 14	CDPOT1414E		4,374.00	209
16 X 6	CDPOT1606E	2	3,787.00	231
16 X 8	CDPOT1608E	4	4,117.00	265
16 X 10	CDPOT1610E		4,286.00	232
16 X 12	CDPOT1612E	4	4,877.00	300
16 X 14	CDPOT1614E		6,097.00	349
16 X 16	CDPOT1616E	4	5,825.00	261
18 X 6	CDPOT1806E		4,541.00	348
18 X 8	CDPOT1808E		4,241.00	325
18 X 10	CDPOT1810E		4,488.00	344
18 X 12	CDPOT1812E		POA	344
18 X 14	CDPOT1814E		4,462.00	342
18 X 16	CDPOT1816E		4,723.00	362
18 X 18	CDPOT1818E		POA	377
20 X 6	CDPOT2006E		4,631.00	355
20 X 10	CDPOT2010E		4,817.00	369
20 X 12	CDPOT2012E		POA	425
20 X 14	CDPOT2014E		6,313.00	484
20 X 16	CDPOT2016E		7,951.00	510
20 X 18	CDPOT2018E		7,029.00	539
20 X 20	CDPOT2020E		POA	564

Size (in.)	Item No.	Crt. Qty.	List Price (\$)	Wt. (lb.)
24 X 6	CDPOT2406E		6,076.00	450
24 X 8	CDPOT2408E		POA	492
24 X 10	CDPOT2410E		6,235.00	478
24 X 12	CDPOT2412E		8,642.00	541
24 X 14	CDPOT2414E		7,064.00	542
24 X 16	CDPOT2416E		7,378.00	566
24 X 18	CDPOT2418E	2	7,731.00	593
24 X 20	CDPOT2420E		8,187.00	628
24 X 24	CDPOT2424E		11,523.00	884

**TEES : PO X FE**

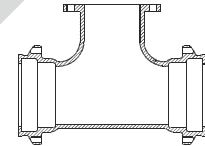

Size (in.)	Item No.	Crt. Qty.	List Price (\$)	Wt. (lb.)
4 X 4	CDPOFT0404E	24	534.00	42
6 X 4	CDPOFT0604E	24	686.00	59
6 X 6	CDPOFT0606E	24	723.00	67
8 X 4	CDPOFT0804E	18	921.00	79
8 X 6	CDPOFT0806E	18	954.00	85
8 X 8	CDPOFT0808E	18	1,156.00	105
10 X 4	CDPOFT1004E	18	1,232.00	97
10 X 6	CDPOFT1006E	8	1,591.00	102
10 X 8	CDPOFT1008E	8	1,769.00	128
10 X 10	CDPOFT1010E	8	1,802.00	165
12 X 4	CDPOFT1204E	12	1,584.00	125
12 X 6	CDPOFT1206E	8	1,624.00	135
12 X 8	CDPOFT1208E	8	1,876.00	155
12 X 10	CDPOFT1210E	4	1,907.00	142
12 X 12	CDPOFT1212E	4	2,676.00	210
14 X 6	CDPOFT1406E		3,203.00	212
14 X 8	CDPOFT1408E		4,522.00	265
14 X 10	CDPOFT1410E		4,072.00	246
14 X 12	CDPOFT1412E		4,855.00	296
14 X 14	CDPOFT1414E		5,248.00	321
16 X 6	CDPOFT1606E	8	3,435.00	236
16 X 8	CDPOFT1608E	8	4,255.00	269
16 X 10	CDPOFT1610E		4,171.00	330

Contd.....

CALL FOR BARE/BARE FITTINGS

**TEES : PO X FE**  
Contd.....

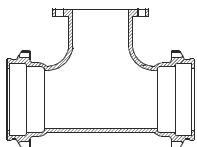

Size (in.)	Item No.	Crt. Qty.	List Price (\$)	Wt. (lb.)
16 X 12	CDPOFT1612E	4	4,056.00	348
16 X 14	CDPOFT1614E		5,573.00	342
16 X 16	CDPOFT1616E	4	5,781.00	355
18 X 6	CDPOFT1806E		3,927.00	301
18 X 8	CDPOFT1808E		4,161.00	319
18 X 10	CDPOFT1810E		4,394.00	337
18 X 14	CDPOFT1814E		5,123.00	393
18 X 16	CDPOFT1816E		5,477.00	420
20 X 6	CDPOFT2006E		4,447.00	341
20 X 10	CDPOFT2010E		5,711.00	420
20 X 14	CDPOFT2014E		6,449.00	474
20 X 16	CDPOFT2016E		6,775.00	498
20 X 18	CDPOFT2018E		10,289.00	528
24 X 6	CDPOFT2406E		6,957.00	512
24 X 8	CDPOFT2408E		8,931.00	594
24 X 10	CDPOFT2410E		6,364.00	468
24 X 12	CDPOFT2412E		6,839.00	503
24 X 14	CDPOFT2414E		7,218.00	531
24 X 16	CDPOFT2416E		7,546.00	555

**PO CROSSES**

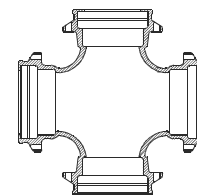

Size (in.)	Item No.	Crt. Qty.	List Price (\$)	Wt. (lb.)
4 X 4	CDPOX0404E		760.00	56
6 X 4	CDPOX0604E		904.00	69
6 X 6	CDPOX0606E	12	860.00	83
8 X 4	CDPOX0804E		1,582.00	117
8 X 6	CDPOX0806E	12	1,276.00	115
8 X 8	CDPOX0808E	12	1,451.00	128
10 X 4	CDPOX1004E		1,603.00	116
10 X 6	CDPOX1006E		2,299.00	
10 X 8	CDPOX1008E		2,753.00	159
10 X 10	CDPOX1010E		2,284.00	165
12 X 8	CDPOX1208E	8	2,030.00	197
12 X 10	CDPOX1210E		2,608.00	195
12 X 12	CDPOX1212E		2,747.00	241
14 X 6	CDPOX1406E		2,393.00	189
14 X 8	CDPOX1408E		2,579.00	204
14 X 10	CDPOX1410E		2,808.00	222
14 X 12	CDPOX 1412E		3,024.00	239
14 X 14	CDPOX1414E		3,412.00	270
16 X 6	CDPOX1606E		2,989.00	234
16 X 8	CDPOX1608E		4,082.00	323
16 X 10	CDPOX1610E		POA	268
16 X 12	CDPOX1612E		3,467.00	274
16 X 14	CDPOX 1614E		POA	322
16 X 16	CDPOX1616E		4,010.00	317
24 X 24	CDPOX2424E		POA	1178

**HYDRANT TEES : PO X SWIVEL**

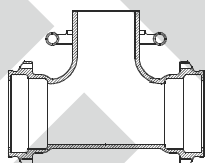

Size (in.)	Item No.	Crt. Qty.	List Price (\$)	Wt. (lb.)
6 X 6	CDPOHT0606E	24	760.00	70
8 X 6	CDPOHT0806E	24	1,264.00	90
8 X 8	CDPOHT0808E		1,393.00	110
10X 6	CDPOHT1006E		1,646.00	100
10X 8	CDPOHT1008E		1,976.00	156
12X 6	CDPOHT1206E	16	2,001.00	138
12X 8	CDPOHT1208E		2,002.00	158
14X 6	CDPOHT1406E		2,557.00	202
16X 6	CDPOHT1606E	2	2,897.00	230
16X 8	CDPOHT1608E		3,689.00	292
18X 6	CDPOHT1806E		4,541.00	348
18X 8	CDPOHT1808E		4,227.00	324
20X 6	CDPOHT2006E		5,215.00	400
24X 6	CDPOHT2406E		6,844.00	525

**TEES : PO X PE**

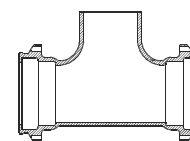

Size (in.)	Item No.	Crt. Qty.	List Price (\$)	Wt. (lb.)
6 X 6	CDPOPET0606E	24	781.00	60
8 X 6	CDPOPET0806E	18	1,186.00	75
12X 6	CDPOPET1206E	8	1,753.00	132

CALL FOR BARE/BARE FITTINGS

**TEES : PO TAPPED 2"**

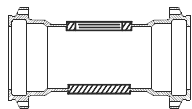

Size (in.)	Item No.	Crt. Qty.	List Price (\$)	Wt. (lb.)
4	CDCDPOTT04E		408.00	27
6	CDCDPOTT06E		543.00	38
8	CDCDPOTT08E		804.00	59
10	CDCDPOTT10E		959.00	72
12	CDCDPOTT12E		1,219.00	92

**PO FLANGE ADAPTER**

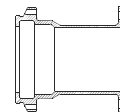

Size (in.)	Item No.	Crt. Qty.	List Price (\$)	Wt. (lb.)
4	CDPOFA04E	80	311.00	22
6	CDPOFA06E	48	476.00	34
8	CDPOFA08E	36	657.00	50
10	CDPOFA10E	24	827.00	70
12	CDPOFA12E	16	1,261.00	80
14	CDPOFA14E		2,188.00	113
16	CDPOFA16E	8	2,483.00	180
18	CDPOFA18E		3,492.00	226
20	CDPOFA20E		3,851.00	264
24	CDPOFA24E	4	7,029.00	308

**PO LATERAL WYES**

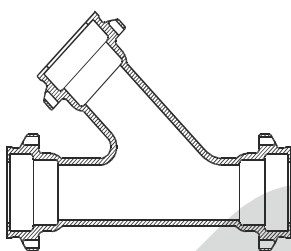

Size (in.)	Item No.	Crt. Qty.	List Price (\$)	Wt. (lb.)
4 X 4	CDPOL0404E	8	483.00	55
6 X 4	CDPOL0604E	8	1,028.00	75
6 X 6	CDPOL0606E	8	1,254.00	83
8 X 4	CDPOL0804E		1,273.00	90
8 X 6	CDPOL0806E	8	1,728.00	125
8 X 8	CDPOL0808E	8	2,028.00	140
10X 4	CDPOL1004E		1,515.00	141
10X 6	CDPOL1006E		1,921.00	155
10X 8	CDPOL1008E		2,494.00	160
10X10	CDPOL1010E	4	2,320.00	170
12X 4	CDPOL1204E		2,405.00	178
12X 6	CDPOL1206E		2,544.00	234
12X 8	CDPOL1208E		2,790.00	260
12X10	CDPOL1210E		3,058.00	280
12X12	CDPOL1212E	3	3,077.00	300
14X 6	CDPOL1406E		2,984.00	236
14X 8	CDPOL1408E		3,224.00	255
14X10	CDPOL1410E		4,108.00	325
14X14	CDPOL1414E		5,996.00	475
16X 6	CDPOL1606E		3,554.00	281
16X 8	CDPOL1608E		3,843.00	304
16X12	CDPOL1612E		4,371.00	346
16X16	CDPOL1616E		4,799.00	380

**REDUCERS : PO X PO**

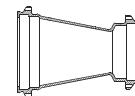

Size (in.)	Item No.	Crt. Qty.	List Price (\$)	Wt. (lb.)
6 X 4	CDPOR0604E	60	349.00	30
8 X 4	CDPOR0804E	36	495.00	40
8 X 6	CDPOR0806E	36	509.00	40
10X 4	CDPOR1004E		941.00	55
10X 6	CDPOR1006E		733.00	60
10X 8	CDPOR1008E	18	811.00	65
12X 4	CDPOR1204E	12	1,033.00	70
12X 6	CDPOR1206E	18	872.00	75
12X 8	CDPOR1208E	12	943.00	80
12X10	CDPOR1210E	12	1,130.00	107
14X 6	CDPOR1406E		948.00	84
14X 8	CDPOR1408E		961.00	85
14X10	CDPOR1410E		986.00	87
14X12	CDPOR1412E		1,174.00	104
16X 6	CDPOR1606E	4	1,996.00	138
16X 8	CDPOR1608E	4	2,070.00	137
16X10	CDPOR1610E	4	2,023.00	130
16X12	CDPOR1612E	4	2,135.00	135
16X14	CDPOR1614E		1,760.00	139
18X 8	CDPOR1808E		1,860.00	142
18X10	CDPOR1810E		1,973.00	151
18X12	CDPOR1812E		2,188.00	167
18X14	CDPOR1814E		2,837.00	217

CALL FOR BARE/BARE FITTINGS

Contd.....



**REDUCERS : PO X PO**

Contd.....

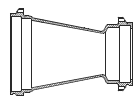

Size (in.)	Item No.	Crt. Qty.	List Price (\$)	Wt. (lb.)
18X16	CDPOR1816E		2,640.00	202
20X10	CDPOR2010E		2,350.00	180
20X12	CDPOR2012E		2,680.00	205
20X14	CDPOR2014E		3,039.00	233
20X16	CDPOR2016E		3,262.00	250
20X18	CDPOR2018E		3,239.00	248
24X12	CDPOR2412E		3,211.00	337
24X14	CDPOR2414E		3,668.00	339
24X16	CDPOR2416E		4,955.00	340
24X18	CDPOR2418E		5,087.00	390
24X20	CDPOR2420E		5,490.00	421

**REDUCERS : PO X FE**

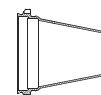

Size (in.)	Item No.	Crt. Qty.	List Price (\$)	Wt. (lb.)
6 X 4	CDPOFR0604E	16	430.00	32
8 X 4	CDPOFR0804E	16	625.00	46
8 X 6	CDPOFR0806E	36	631.00	47
10X 4	CDPOFR1004E		703.00	55
10X 6	CDPOFR1006E	12	753.00	59
10X 8	CDPOFR1008E	18	1,190.00	60
12X 4	CDPOFR1204E		991.00	78
12X 6	CDPOFR1206E	8	958.00	73
12X 8	CDPOFR1208E	8	941.00	74
12X10	CDPOFR1210E		1,207.00	95
14X 6	CDPOFR1406E		1,536.00	121
14X 8	CDPOFR1408E		1,624.00	128
14X10	CDPOFR1410E		1,613.00	127
14X12	CDPOFR1412E		1,825.00	144
16X 6	CDPOFR1606E		1,685.00	136
16X 8	CDPOFR1608E		1,788.00	144
16X10	CDPOFR1610E		2,002.00	160
16X12	CDPOFR1612E	4	2,175.00	170
16X14	CDPOFR1614E		2,481.00	196
18X 8	CDPOFR1808E		2,055.00	157
18X10	CDPOFR1810E		2,290.00	175
18X12	CDPOFR1812E		2,809.00	215
18X14	CDPOFR1814E		3,055.00	234
18X16	CDPOFR1816E		3,211.00	246
20X10	CDPOFR2010E		3,055.00	234
20X14	CDPOFR2014E		3,254.00	249
20X16	CDPOFR2016E		3,549.00	272
24X12	CDPOFR2412E		3,422.00	262
24X14	CDPOFR2414E		4,110.00	315
24X16	CDPOFR2416E		4,283.00	328

**PUSH-ON GASKET**



Size (in.)	Item No.	Crt. Qty.	List Price (\$)	Wt. (lb.)
4	6655.04E	180	POA	0.4
6	6655.06E	100	POA	0.6
8	6655.08E	80	POA	0.7
10	6655.10E	60	POA	0.9
12	6655.12E	60	POA	1.0
14	6655.14E	60	POA	1.3
16	6655.16E	50	POA	1.5

**TRANSITION PUSH-ON GASKET**



Size (in.)	Item No.	Crt. Qty.	List Price (\$)	Wt. (lb.)
4	6656.04E	180	POA	0.4
6	6656.06E	100	POA	0.6
8	6656.08E	80	POA	0.7
10	6656.10E	60	POA	0.9
12	6656.12E	60	POA	1.0

CALL FOR BARE/BARE FITTINGS

## PO CAPS SOLID

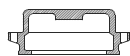

Size (in.)	Item No.	Crt. Qty.	List Price (\$)	Wt. (lb.)
4	CDPOC04E	120	156.00	13
6	CDPOC06E	72	233.00	20
8	CDPOC08E	54	361.00	32
10	CDPOC10E	36	475.00	40
12	CDPOC12E	24	666.00	63
14	CDPOC14E		POA	70
16	CDPOC16E	12	POA	110
18	CDPOC18E		POA	120
20	CDPOC20E		POA	150
24	CDPOC24E	4	POA	216

## PO CAPS TAPPED

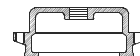

Size (in.)	Item No.	Crt. Qty.	List Price (\$)	Wt. (lb.)
4	CDPOCT04E	120	220.00	13
6	CDPOCT06E	72	300.00	20
8	CDPOCT08E	54	427.00	32
10	CDPOCT10E	36	541.00	40
12	CDPOCT12E	24	732.00	63
14	CDPOCT14E		POA	70
16	CDPOCT16E	12	POA	110
18	CDPOCT18E		POA	120
20	CDPOCT20E		POA	150
24	CDPOCT24E		POA	216

## PO PLUGS SOLID

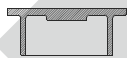

Size (in.)	Item No.	Crt. Qty.	List Price (\$)	Wt. (lb.)
4	CDPOP04E	200	119.00	12
6	CDPOP06E	96	201.00	18
8	CDPOP08E	72	275.00	29
10	CDPOP10E	36	411.00	35
12	CDPOP12E	30	475.00	46
14	CDPOP14E		1,273.00	74
16	CDPOP16E	20	3,896.00	60
18	CDPOP18E		4,214.00	120
20	CDPOP20E		4,580.00	145
24	CDPOP24E	4	4,889.00	204

## PO PLUGS TAPPED

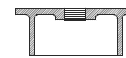

Size (in.)	Item No.	Crt. Qty.	List Price (\$)	Wt. (lb.)
4	CDPOPT04E	100	160.00	12
6	CDPOPT06E	72	268.00	18
8	CDPOPT08E	54	340.00	29
10	CDPOPT10E	36	477.00	35
12	CDPOPT12E	24	538.00	46
14	CDPOPT14E		1,591.00	74
16	CDPOPT16E	8	4,560.00	60
18	CDPOPT18E		4,805.00	120
20	CDPOPT20E		5,089.00	145
24	CDPOPT24E	4	5,983.00	204

CALL FOR BARE/BARE FITTINGS

# Utility Pipe Fittings Fusion Bonded Epoxy

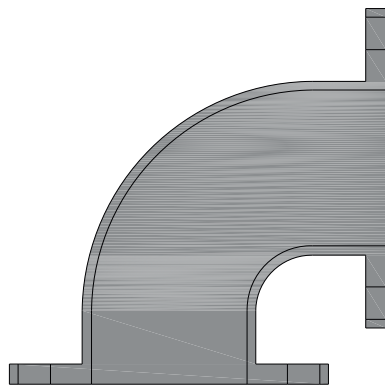

ANSI/AWWA C110/A21.10  
**FLANGE FITTINGS**  
FUSION BONDED EPOXY

## PRICE LIST

**Effective December 16, 2024**



**FLANGE BENDS  
90° (1/4)**

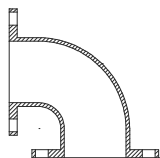

Size (in.)	Item No.	List Price (\$)	Wt. (lb.)
2	DFB9002E	201.00	14
3	DFB9003E	255.00	25
4	DFB9004E	358.00	45
6	DFB9006E	554.00	65
8	DFB9008E	909.00	105
10	DFB9010E	1,433.00	165
12	DFB9012E	2,026.00	235
14	DFB9014E	2,652.00	290
16	DFB9016E	3,284.00	370
18	DFB9018E	4,480.00	450
20	DFB9020E	5,499.00	580
24	DFB9024E	9,012.00	900
30	DFB9030E	15,474.00	1430
36	DFB9036E	21,023.00	2135
42	DFB9042E	38,586.00	3055
48	DFB9048E	51,693.00	4095
54	DFB9054E	POA	3740

**FLANGE BENDS  
45° (1/8)**

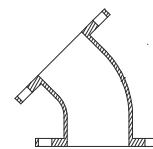

Size (in.)	Item No.	List Price (\$)	Wt. (lb.)
2	DFB4502E	207.00	12
3	DFB4503E	195.00	20
4	DFB4504E	346.00	40
6	DFB4506E	534.00	55
8	DFB4508E	820.00	90
10	DFB4510E	1,316.00	130
12	DFB4512E	1,713.00	195
14	DFB4514E	2,027.00	220
16	DFB4516E	2,575.00	280
18	DFB4518E	3,459.00	325
20	DFB4520E	4,636.00	430
24	DFB4524E	6,413.00	630
30	DFB4530E	13,394.00	1120
36	DFB4536E	20,985.00	1755
42	DFB4542E	32,819.00	2600
48	DFB4548E	45,190.00	3580
54	DFB4554E	POA	2735

**FLANGE BENDS  
22½° (1/16)**

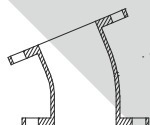

Size (in.)	Item No.	List Price (\$)	Wt. (lb.)
2	DFB2202E	273.00	12
3	DFB2203E	213.00	20
4	DFB2204E	345.00	40
6	DFB2206E	514.00	55
8	DFB2208E	799.00	90
10	DFB2210E	1,257.00	135
12	DFB2212E	1,838.00	205
14	DFB2214E	2,320.00	225
16	DFB2216E	2,661.00	285
18	DFB2218E	3,566.00	335
20	DFB2220E	4,914.00	435
24	DFB2224E	7,225.00	640
30	DFB2230E	13,573.00	1135
36	DFB2236E	21,403.00	1790
42	DFB2242E	33,644.00	2665
48	DFB2248E	46,266.00	3665
54	DFB2254E	POA	2260

**FLANGE BENDS  
11¼° (1/32)**

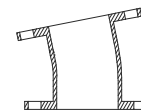

Size (in.)	Item No.	List Price (\$)	Wt. (lb.)
2	DFB1102E	273.00	12
3	DFB1103E	213.00	20
4	DFB1104E	401.00	40
6	DFB1106E	620.00	55
8	DFB1108E	846.00	90
10	DFB1110E	1,395.00	135
12	DFB1112E	2,117.00	205
14	DFB1114E	2,412.00	225
16	DFB1116E	2,939.00	285
18	DFB1118E	3,566.00	335
20	DFB1120E	4,914.00	435
24	DFB1124E	7,596.00	645
30	DFB1130E	13,754.00	1150
36	DFB1136E	21,583.00	1805
42	DFB1142E	33,832.00	2680
48	DFB1148E	46,644.00	3695
54	DFB1154E	POA	2100

CALL FOR BARE/BARE FITTINGS

**90° LONG RADIUS BENDS**

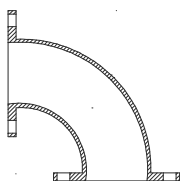

Size (in.)	Item No.	List Price (\$)	Wt. (lb.)
3	DFBLR9003E	317.00	30
4	DFBLR9004E	531.00	30
6	DFBLR9006E	912.00	80
8	DFBLR9008E	1,512.00	140
10	DFBLR9010E	2,217.00	215
12	DFBLR9012E	3,350.00	325
14	DFBLR9014E	3,965.00	580
16	DFBLR9016E	5,201.00	740
18	DFBLR9018E	6,693.00	840
20	DFBLR9020E	9,147.00	928
24	DFBLR9024E	13,999.00	1640
30	DFBLR9030E	25,169.00	2105
36	DFBLR9036E	39,274.00	3285
42	DFBLR9042E	61,413.00	4865
48	DFBLR9048E	85,706.00	7800
54	DFBLR9054E	POA	6205

**90° FLANGE X FLARE BENDS**

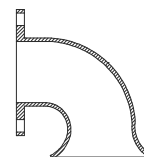

Size (in.)	Item No.	List Price (\$)	Wt. (lb.)
3	DFF9003E	267.00	25
4	DFF9004E	474.00	40
6	DFF9006E	726.00	70
8	DFF9008E	1,238.00	110
10	DFF9010E	2,014.00	175
12	DFF9012E	2,526.00	245
14	DFF9014E	3,500.00	340
16	DFF9016E	4,736.00	460
18	DFF9018E	5,952.00	560
20	DFF9020E	7,904.00	700
24	DFF9024E	11,437.00	1100
30	DFF9030E	23,555.00	1840
36	DFF9036E	32,636.00	2700
42	DFF9042E	40,393.00	3250
48	DFF9048E	66,080.00	4215
54	DFF9054E	POA	3965

**STRAIGHT FLANGE X FLARE**

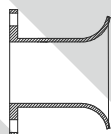

Size (in.)	Item No.	List Price (\$)	Wt. (lb.)
3	DFP03E	213.00	20
4	DFP04E	317.00	30
6	DFP06E	414.00	40
8	DFP08E	726.00	70
10	DFP10E	984.00	95
12	DFP12E	1,602.00	115
14	DFP14E	1,706.00	190
16	DFP16E	2,474.00	330
18	DFP18E	2,928.00	355
20	DFP20E	4,025.00	460
24	DFP24E	5,422.00	635
30	DFP30E	13,153.00	1025
36	DFP36E	17,456.00	1460
42	DFP42E	22,095.00	1900
48	DFP48E	29,982.00	2350
54	DFP54E	POA	2035

**LONG RADIUS 90° FLANGE X FLARE BENDS**

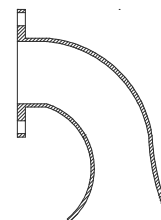

Size (in.)	Item No.	List Price (\$)	Wt. (lb.)
3	DFFLR9003E	365.00	30
4	DFFLR9004E	521.00	50
6	DFFLR9006E	931.00	90
8	DFFLR9008E	1,602.00	115
10	DFFLR9010E	2,579.00	250
12	DFFLR9012E	3,864.00	375
14	DFFLR9014E	5,147.00	500
16	DFFLR9016E	7,357.00	715
18	DFFLR9018E	8,497.00	800
20	DFFLR9020E	12,866.00	1140
24	DFFLR9024E	15,075.00	1335
30	DFFLR9030E	26,183.00	2190
36	DFFLR9036E	41,427.00	3465
42	DFFLR9042E	65,006.00	5150
48	DFFLR9048E	84,885.00	6725

**CALL FOR BARE/BARE FITTINGS**

## 90° REDUCING BENDS

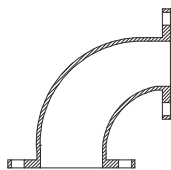

Size (in.)	Item No.	List Price (\$)	Wt. (lb.)
4 X 3	DFBR0403E	307.00	35
6 X 3	DFBR0603E	582.00	45
6 X 4	DFBR0604E	571.00	55
6 X 5	DFBR0605E	582.00	
8 X 4	DFBR0804E	779.00	80
8 X 6	DFBR0806E	886.00	90
10X 4	DFBR1004E	1,343.00	105
10X 6	DFBR1006E	1,395.00	125
10X 8	DFBR1008E	1,547.00	150
12X 4	DFBR1204E	1,445.00	
12X 6	DFBR1206E	1,651.00	165
12X 8	DFBR1208E	1,943.00	190
12X10	DFBR1210E	2,060.00	220
14X 6	DFBR1406E	1,961.00	144
14X 8	DFBR1408E	2,217.00	200
14X10	DFBR1410E	2,474.00	260
14X12	DFBR1412E	2,784.00	270
16X 6	DFBR1606E	2,268.00	220
16X 8	DFBR1608E	2,474.00	240
16X10	DFBR1610E	2,887.00	344
16X12	DFBR1612E	3,192.00	373
16X14	DFBR1614E	3,453.00	330
18X 6	DFBR1806E	2,766.00	260
18X 8	DFBR1808E	3,466.00	280
18X10	DFBR1810E	3,512.00	320
18X12	DFBR1812E	3,724.00	465
18X14	DFBR1814E	4,096.00	370
18X16	DFBR1816E	4,462.00	410
20X 6	DFBR2006E	3,618.00	320
20X 8	DFBR2008E	3,901.00	345
20X10	DFBR2010E	5,028.00	385
20X12	DFBR2012E	5,132.00	415
20X14	DFBR2014E	5,731.00	518
20X16	DFBR2016E	5,593.00	533
20X18	DFBR2018E	5,934.00	515
24X 6	DFBR2406E	5,422.00	480
24X 8	DFBR2408E	5,707.00	505
24X10	DFBR2410E	6,157.00	545
24X12	DFBR2412E	6,497.00	575
24X14	DFBR2414E	7,172.00	595

Size (in.)	Item No.	List Price (\$)	Wt. (lb.)
24X16	DFBR2416E	7,736.00	635
24X18	DFBR2418E	7,810.00	675
24X20	DFBR2420E	8,355.00	740
30X12	DFBR3012E	10,046.00	840
30X14	DFBR3014E	12,368.00	860
30X16	DFBR3016E	10,760.00	900
30X18	DFBR3018E	15,973.00	940
30X20	DFBR3020E	16,941.00	1005
30X24	DFBR3024E	14,411.00	1165
36X12	DFBR3612E	14,290.00	1195
36X14	DFBR3614E	18,289.00	1215
36X16	DFBR3616E	15,009.00	1255
36X18	DFBR3618E	19,344.00	1295
36X20	DFBR3620E	20,033.00	1315
36X24	DFBR3624E	18,954.00	1520
36X30	DFBR3630E	21,996.00	1785
42X12	DFBR4212E	POA	1655
42X14	DFBR4214E	25,407.00	1675
42X16	DFBR4216E	21,652.00	1715
42X18	DFBR4218E	28,628.00	1755
42X20	DFBR4220E	28,325.00	1820
42X24	DFBR4224E	24,999.00	1980
42X30	DFBR4230E	29,605.00	2245
42X36	DFBR4236E	42,793.00	2600
48X12	DFBR4812E	27,458.00	2175
48X14	DFBR4814E	32,868.00	2195
48X16	DFBR4816E	28,217.00	2235
48X18	DFBR4818E	39,749.00	2275
48X20	DFBR4820E	42,951.00	2340
48X24	DFBR4824E	40,899.00	2500
48X30	DFBR4830E	44,704.00	2765
48X36	DFBR4836E	44,974.00	3115
48X42	DFBR4842E	59,138.00	3580
54X12	DFBR5412E	POA	1990
54X14	DFBR5414E	POA	2015
54X16	DFBR5416E	POA	2055
54X18	DFBR5418E	POA	2095
54X20	DFBR5420E	POA	2160
54X24	DFBR5424E	POA	2320
54X30	DFBR5430E	POA	2585
54X36	DFBR5436E	POA	2940
54X42	DFBR5442E	POA	3395
54X48	DFBR5448E	POA	3565

CALL FOR BARE/BARE FITTINGS

**90° BASE BENDS**

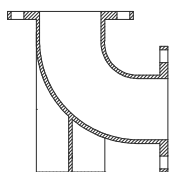

Size (in.)	Item No.	List Price (\$)	Wt. (lb.)
3	DFBB9003E	365.00	35
4	DFBB9004E	571.00	55
6	DFBB9006E	838.00	85
8	DFBB9008E	1,582.00	145
10	DFBB9010E	2,166.00	210
12	DFBB9012E	3,085.00	300
14	DFBB9014E	3,708.00	320
16	DFBB9016E	4,582.00	445
18	DFBB9018E	6,007.00	565
20	DFBB9020E	7,904.00	700
24	DFBB9024E	11,630.00	1030
30	DFBB9030E	19,431.00	1625
36	DFBB9036E	28,514.00	2385
42	DFBB9042E	52,780.00	3465
48	DFBB9048E	58,191.00	4610
54	DFBB9054E	POA	4415

**90° LONG RADIUS BASE BENDS**

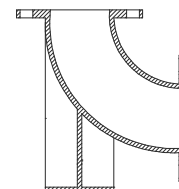

Size (in.)	Item No.	List Price (\$)	Wt. (lb.)
3	DFBBLR9003E	396.00	40
4	DFBBLR9004E	622.00	60
6	DFBBLR9006E	1,031.00	100
8	DFBBLR9008E	1,857.00	180
10	DFBBLR9010E	2,707.00	260
12	DFBBLR9012E	4,245.00	390
14	DFBBLR9014E	4,295.00	650
16	DFBBLR9016E	7,614.00	815
18	DFBBLR9018E	8,497.00	955
20	DFBBLR9020E	11,122.00	1200
24	DFBBLR9024E	16,140.00	1770
30	DFBBLR9030E	28,689.00	2295
36	DFBBLR9036E	43,991.00	3535
42	DFBBLR9042E	69,615.00	5275
48	DFBBLR9048E	96,370.00	7305
54	DFBBLR9054E	POA	6880

**BASE TEES**

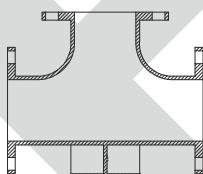

Size (in.)	Item No.	List Price (\$)	Wt. (lb.)
3	DFTB0303E	474.00	45
4	DFTB0404E	779.00	75
6	DFTB0606E	1,138.00	110
8	DFTB0808E	1,913.00	185
10	DFTB1010E	3,091.00	300
12	DFTB1212E	4,427.00	430
14	DFTB1414E	4,995.00	500
16	DFTB1616E	6,174.00	600
18	DFTB1818E	7,861.00	740
20	DFTB2020E	10,499.00	930
24	DFTB2424E	15,918.00	1410
30	DFTB3030E	27,141.00	2270
36	DFTB3636E	39,687.00	3320
42	DFTB4242E	73,840.00	5850
48	DFTB4848E	97,442.00	7720
54	DFTB5454E	POA	6465

CALL FOR BARE/BARE FITTINGS

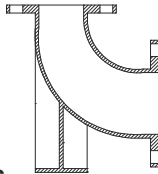
**90° REDUCING BASE BENDS**  
 (WITH BASE UNDER SMALL END)

R - Available multiple size reductions.

Size (in.)	Item No.	List Price (\$)	Wt. (lb.)
4 X 3	DFBBSDR0403E	POA	45
6 X 4	DFBBSDR0604E	POA	75
8 X 4	DFBBSDR0804E	POA	120
8 X 6	DFBBSDR0806E	POA	130
10X 6	DFBBSDR1006E	POA	170
10X 8	DFBBSDR1008E	POA	195
12X 6	DFBBSDR1206E	POA	230
12X 8	DFBBSDR1208E	POA	255
12X10	DFBBSDR1210E	POA	285
14X R	DFBBSDR14E	POA	
16X R	DFBBSDR16E	POA	
18X R	DFBBSDR18E	POA	
20X R	DFBBSDR20E	POA	
24X R	DFBBSDR24E	POA	
30X R	DFBBSDR30E	POA	
36X R	DFBBSDR36E	POA	
42X R	DFBBSDR42E	POA	
48X R	DFBBSDR48E	POA	
54X R	DFBBSDR54E	POA	

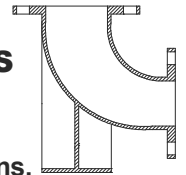
**90° REDUCING BASE BENDS**  
 (WITH BASE UNDER LARGE END)

R - Available multiple size reductions.

Size (in.)	Item No.	List Price (\$)	Wt. (lb.)
4 X 3	DFBBLDR0403E	POA	45
6 X 4	DFBBLDR0604E	POA	75
8 X 4	DFBBLDR0804E	POA	120
8 X 6	DFBBLDR0806E	POA	130
10X 6	DFBBLDR1006E	POA	170
10X 8	DFBBLDR1008E	POA	195
12X 6	DFBBLDR1206E	POA	230
12X 8	DFBBLDR1208E	POA	255
12X10	DFBBLDR1210E	POA	285
14X R	DFBBLDR14E	POA	
16X R	DFBBLDR16E	POA	
18X R	DFBBLDR18E	POA	
20X R	DFBBLDR20E	POA	
24X R	DFBBLDR24E	POA	
30X R	DFBBLDR30E	POA	
36X R	DFBBLDR36E	POA	
42X R	DFBBLDR42E	POA	
48X R	DFBBLDR48E	POA	
54X R	DFBBLDR54E	POA	

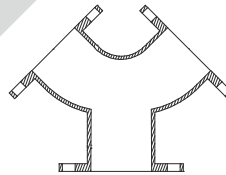
**TRUE WYES**

Size (in.)	Item No.	List Price (\$)	Wt. (lb.)
4 X 4 X 4	DFYT0404E	521.00	50
6 X 4 X 4	DFYT060404E	POA	75
6 X 6 X 6	DFYT0606E	829.00	80
8 X 6 X 6	DFYT080606E	POA	120
8 X 8 X 4	DFYT080804E	POA	
8 X 8 X 8	DFYT0808E	1,445.00	125
10 X 10 X 6	DFYT101006E	POA	
10 X 8 X 8	DFYT100808E	POA	155
10 X 10 X 10	DFYT101010E	1,913.00	185
12 X 12 X 6	DFYT121206E	POA	
12 X 12 X 8	DFYT121208E	POA	

Size (in.)	Item No.	List Price (\$)	Wt. (lb.)
12 X 12 X 10	DFYT121210E	POA	
12 X 12 X 12	DFYT1212E	3,091.00	300
14 X 14 X 14	DFYT1414E	4,273.00	415
16 X 16 X 16	DFYT1616E	5,973.00	580
18 X 18 X 18	DFYT1818E	7,224.00	680
20 X 20 X 20	DFYT2020E	10,839.00	960
24 X 24 X 24	DFYT2424E	15,466.00	1370
30 X 30 X 30	DFYT3030E	POA	80
36 X 36 X 36	DFYT3636E	POA	120
42 X 42 X 42	DFYT4242E	POA	125
48 X 48 X 48	DFYT4848E	POA	120

CALL FOR BARE/BARE FITTINGS



**FLANGE TEES**

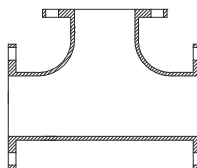

Size (in.)	Item No.	List Price (\$)	Wt. (lb.)
2 X 2	DFT0202E	252.00	20
3 X 2	DFT0302E	365.00	35
3 X 3	DFT0303E	361.00	40
4 X 2	DFT0402E	521.00	50
4 X 3	DFT0403E	622.00	60
4 X 4	DFT0404E	678.00	65
5 X 5	DFT0505E	886.00	80
6 X 2	DFT0602E	886.00	156
6 X 3	DFT0603E	931.00	85
6 X 4	DFT0604E	887.00	90
6 X 6	DFT0606E	1,427.00	95
8 X 3	DFT0803E	1,371.00	130
8 X 4	DFT0804E	1,275.00	140
8 X 6	DFT0806E	1,475.00	145
8 X 8	DFT0808E	POA	155
10X 4	DFT1004E	1,916.00	205
10X 6	DFT1006E	1,828.00	215
10X 8	DFT1008E	1,922.00	225
10X10	DFT1010E	2,232.00	270
12X 4	DFT1204E	2,620.00	290
12X 6	DFT1206E	2,548.00	295
12X 8	DFT1208E	2,686.00	310
12X10	DFT1210E	3,165.00	360
12X12	DFT1212E	3,231.00	385
14X 4	DFT1404E	POA	370
14X 6	DFT1406E	3,864.00	375
14X 8	DFT1408E	4,017.00	390
14X10	DFT1410E	4,117.00	400
14X12	DFT1412E	4,377.00	425
14X14	DFT1414E	4,481.00	435
16X 4	DFT1604E	POA	460
16X 6	DFT1606E	4,505.00	465
16X 8	DFT1608E	4,405.00	475
16X10	DFT1610E	5,065.00	495
16X12	DFT1612E	4,892.00	520
16X14	DFT1614E	5,458.00	530
16X16	DFT1616E	4,627.00	550
18X 6	DFT1806E	4,595.00	480
18X 8	DFT1808E	5,067.00	495
18X10	DFT1810E	5,421.00	510

Size (in.)	Item No.	List Price (\$)	Wt. (lb.)
18X12	DFT1812E	5,912.00	535
18X14	DFT1814E	6,587.00	630
18X16	DFT1816E	6,907.00	650
18X18	DFT1818E	6,441.00	785
20X 6	DFT2006E	6,891.00	610
20X 8	DFT2008E	7,002.00	620
20X10	DFT2010E	7,172.00	635
20X12	DFT2012E	7,453.00	660
20X14	DFT2014E	7,511.00	665
20X16	DFT2016E	9,147.00	810
20X18	DFT2018E	9,261.00	820
20X20	DFT2020E	8,150.00	855
24X 4	DFT2404E	9,544.00	
24X 6	DFT2406E	8,244.00	845
24X 8	DFT2408E	9,713.00	860
24X10	DFT2410E	9,936.00	880
24X12	DFT2412E	8,628.00	890
24X14	DFT2414E	10,087.00	900
24X16	DFT2416E	8,840.00	915
24X18	DFT2418E	13,773.00	1220
24X20	DFT2420E	14,170.00	1510
24X24	DFT2424E	12,897.00	1330
30X 6	DFT3006E	17,402.00	1450
30X 8	DFT3008E	17,456.00	
30X10	DFT3010E	17,816.00	
30X12	DFT3012E	17,816.00	1490
30X14	DFT3014E	17,816.00	1490
30X16	DFT3016E	17,997.00	1505
30X18	DFT3018E	18,117.00	1515
30X20	DFT3020E	18,411.00	1540
30X24	DFT3024E	24,212.00	2025
30X30	DFT3030E	22,444.00	2150
36X 6	DFT3606E	23,912.00	
36X 8	DFT3608E	25,706.00	
36X10	DFT3610E	25,767.00	3082
36X12	DFT3612E	25,945.00	2170
36X14	DFT3614E	26,006.00	2175
36X16	DFT3616E	26,126.00	2185
36X18	DFT3618E	26,183.00	2190

Contd.....

**CALL FOR BARE/BARE FITTINGS**

**FLANGE TEES**

Contd.....

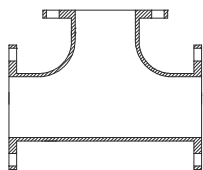

**FLANGE TEES - BULL HEAD**

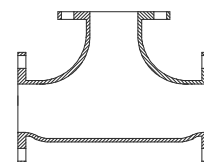

Size (in.)	Item No.	List Price (\$)	Wt. (lb.)
36X20	DFT3620E	26,423.00	2210
36X24	DFT3624E	26,961.00	2255
36X30	DFT3630E	35,862.00	3000
36X36	DFT3636E	33,348.00	3160
42X12	DFT4212E	39,953.00	3165
42X14	DFT4214E	40,016.00	3170
42X16	DFT4216E	40,142.00	3180
42X18	DFT4218E	40,204.00	3185
42X20	DFT4220E	40,461.00	3205
42X24	DFT4224E	40,964.00	3245
42X30	DFT4230E	52,070.00	4125
42X36	DFT4236E	67,657.00	5360
42X42	DFT4242E	70,434.00	5580
48X12	DFT4812E	54,470.00	4315
48X14	DFT4814E	54,470.00	4315
48X16	DFT4816E	54,657.00	4330
48X18	DFT4818E	54,657.00	4330
48X20	DFT4820E	54,908.00	4350
48X24	DFT4824E	55,349.00	4385
48X30	DFT4830E	56,237.00	4455
48X36	DFT4836E	70,119.00	7035
48X42	DFT4842E	90,817.00	7195
48X48	DFT4848E	93,216.00	7385
54X12	DFT5412E	POA	4435
54X14	DFT5414E	POA	4435
54X16	DFT5416E	POA	4450
54X18	DFT5418E	POA	4460
54X20	DFT5420E	POA	4480
54X24	DFT5424E	POA	4515
54X30	DFT5430E	POA	4615
54X36	DFT5436E	POA	4695
54X42	DFT5442E	POA	5740
54X48	DFT5448E	POA	5850
54X54	DFT5454E	POA	6025

Size (in.)	Item No.	List Price (\$)	Wt. (lb.)
4 X 4 X 6	DFTBH040406E	POA	90
6 X 6 X 8	DFTBH060608E	POA	140
8 X 8 X 10	DFTBH080810E	POA	260
8 X 8 X 12	DFTBH080812E	POA	291
10X10X12	DFTBH101012E	POA	355

**FLANGE TEES - REDUCING ON THE RUN**

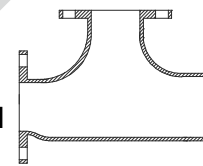

Size (in.)	Item No.	List Price (\$)	Wt. (lb.)
4 X 3 X 3	DFTROR040303E	POA	55
6 X 4 X 4	DFTROR060404E	931.00	103
6 X 4 X 6	DFTROR060406E	931.00	108
8 X 6 X 4	DFTROR080604E	1,458.00	146
8 X 6 X 6	DFTROR080606E	1,294.00	148
8 X 6 X 8	DFTROR080608E	1,498.00	145
10X 6 X 6	DFTROR100606E	3,002.00	275
10X 6 X 10	DFTROR100610E	2,954.00	305
10X 8 X 6	DFTROR100806E	3,019.00	280
10X 8 X 8	DFTROR100808E	3,186.00	302
10X 8 X 10	DFTROR100810E	3,268.00	325
12X 6 X 6	DFTROR120606E	3,732.00	340
12X 6 X 8	DFTROR120608E	3,906.00	360
12X 8 X 6	DFTROR120806E	3,828.00	355
12X 8 X 8	DFTROR120808E	4,045.00	375
12X 8 X 12	DFTROR120812E	4,529.00	420
12X10X 6	DFTROR121006E	3,738.00	390
12X10X 8	DFTROR121008E	4,312.00	400
12X10X10	DFTROR121010E	4,529.00	420
12X10X12	DFTROR121012E	4,743.00	440

CALL FOR BARE/BARE FITTINGS

**FLANGE CROSS**

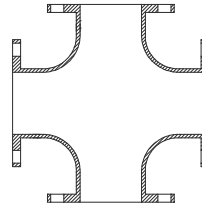

Size (in.)	Item No.	List Price (\$)	Wt. (lb.)
3 X 3	DFX0303E	521.00	50
4 X 3	DFX0403E	726.00	70
4 X 4	DFX0404E	748.00	80
6 X 3	DFX0603E	984.00	95
6 X 4	DFX0604E	1,138.00	110
6 X 6	DFX0606E	1,209.00	120
8 X 3	DFX0803E	POA	140
8 X 4	DFX0804E	1,602.00	155
8 X 6	DFX0806E	1,706.00	175
8 X 8	DFX0808E	1,808.00	195
10X 4	DFX1004E	2,268.00	220
10X 6	DFX1006E	2,474.00	240
10X 8	DFX1008E	2,733.00	265
10X10	DFX1010E	3,401.00	330
12X 4	DFX1204E	3,192.00	310
12X 6	DFX1206E	3,293.00	320
12X 8	DFX1208E	3,556.00	345
12X10	DFX1210E	4,273.00	415
12X12	DFX1212E	4,007.00	460
14X 6	DFX1406E	4,117.00	400
14X 8	DFX1408E	4,377.00	425
14X10	DFX1410E	4,736.00	460
14X12	DFX1412E	5,201.00	505
14X14	DFX1414E	5,458.00	530
16X 6	DFX1606E	5,045.00	490
16X 8	DFX1608E	5,353.00	520
16X10	DFX1610E	5,713.00	555
16X12	DFX1612E	6,231.00	605
16X14	DFX1614E	POA	620
16X16	DFX1616E	6,844.00	755
18X 6	DFX1806E	5,371.00	505
18X 8	DFX1808E	5,686.00	535
18X10	DFX1810E	5,952.00	560
18X12	DFX1812E	6,480.00	610
18X14	DFX1814E	7,648.00	720
18X16	DFX1816E	8,130.00	765
18X18	DFX1818E	8,450.00	795
20X 6	DFX2006E	7,172.00	635
20X 8	DFX2008E	7,511.00	665

Size (in.)	Item No.	List Price (\$)	Wt. (lb.)
20X10	DFX2010E	7,736.00	685
20X12	DFX2012E	8,301.00	735
20X14	DFX2014E	8,415.00	745
20X16	DFX2016E	10,332.00	915
20X18	DFX2018E	10,669.00	945
20X20	DFX2020E	11,461.00	1015
24X 6	DFX2406E	9,885.00	875
24X 8	DFX2408E	10,106.00	895
24X10	DFX2410E	10,499.00	930
24X12	DFX2412E	10,839.00	960
24X14	DFX2414E	11,010.00	975
24X16	DFX2416E	11,405.00	1010
24X18	DFX2418E	15,411.00	1365
24X20	DFX2420E	16,140.00	1430
24X24	DFX2424E	17,723.00	1570
30X10	DFX3010E	POA	
30X12	DFX3012E	18,715.00	1565
30X14	DFX3014E	18,774.00	1570
30X16	DFX3016E	19,195.00	1605
30X18	DFX3018E	19,310.00	1515
30X20	DFX3020E	19,968.00	1670
30X24	DFX3024E	26,844.00	2245
30X30	DFX3030E	29,888.00	2500
36X12	DFX3612E	26,780.00	2240
36X14	DFX3614E	26,780.00	2240
36X16	DFX3616E	27,141.00	2270
36X18	DFX3618E	27,259.00	2280
36X20	DFX3620E	27,797.00	2325
36X24	DFX3624E	28,754.00	2405
36X30	DFX3630E	39,449.00	3300
36X36	DFX3636E	43,275.00	3620
42X12	DFX4212E	40,899.00	3240
42X14	DFX4214E	40,899.00	3240
42X16	DFX4216E	41,279.00	3270
42X18	DFX4218E	41,341.00	3275
42X20	DFX4220E	41,911.00	3320
42X24	DFX4224E	42,858.00	4135
42X30	DFX4230E	55,224.00	4375
42X36	DFX4236E	72,199.00	5720

Contd.....

CALL FOR BARE/BARE FITTINGS

**FLANGE CROSS**

Contd.....

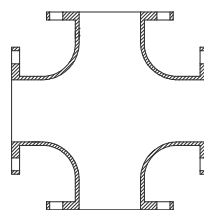

Size (in.)	Item No.	List Price (\$)	Wt. (lb.)
42X42	DFX4242E	77,694.00	6155
48X12	DFX4812E	55,414.00	4390
48X14	DFX4814E	55,349.00	4385
48X16	DFX4816E	55,733.00	4415
48X18	DFX4818E	55,791.00	4420
48X20	DFX4820E	56,297.00	4460
48X24	DFX4824E	57,246.00	4535
48X30	DFX4830E	58,946.00	5705
48X36	DFX4836E	74,218.00	7310
48X42	DFX4842E	96,308.00	7630
48X48	DFX4848E	1,01,042.00	8005

Size (in.)	Item No.	List Price (\$)	Wt. (lb.)
54X12	DFX5412E	POA	4575
54X14	DFX5414E	POA	4575
54X16	DFX5416E	POA	4605
54X18	DFX5418E	POA	4625
54X20	DFX5420E	POA	4665
54X24	DFX5424E	POA	4700
54X30	DFX5430E	POA	4800
54X36	DFX5436E	POA	4950
54X42	DFX5442E	POA	6210
54X48	DFX5448E	POA	6425
54X54	DFX5454E	POA	6780

**FLANGE LATERAL WYES**

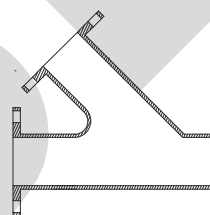

Size (in.)	Item No.	List Price (\$)	Wt. (lb.)
3 X 3	DFY0303E	474.00	45
4 X 2	DFY0402E	571.00	
4 X 3	DFY0403E	678.00	65
4 X 4	DFY0404E	659.00	75
6 X 3	DFY0603E	1,031.00	
6 X 4	DFY0604E	1,188.00	105
6 X 6	DFY0606E	1,054.00	120
8 X 4	DFY0804E	1,857.00	165
8 X 6	DFY0806E	1,794.00	175
8 X 8	DFY0808E	1,726.00	200
10X 4	DFY1004E	2,678.00	240
10X 6	DFY1006E	2,784.00	250
10X 8	DFY1008E	3,042.00	335
10X10	DFY1010E	2,756.00	335
12X 4	DFY1204E	3,913.00	350
12X 6	DFY1206E	4,070.00	427
12X 8	DFY1208E	4,017.00	452

Size (in.)	Item No.	List Price (\$)	Wt. (lb.)
12X10	DFY1210E	4,686.00	420
12X12	DFY1212E	4,201.00	515
14X 6	DFY1406E	5,353.00	475
14X 8	DFY1408E	5,612.00	500
14X10	DFY1410E	5,408.00	525
14X12	DFY1412E	6,379.00	570
14X14	DFY1414E	6,231.00	605
16X 6	DFY1606E	6,379.00	620
16X 8	DFY1608E	7,306.00	645
16X10	DFY1610E	7,614.00	675
16X12	DFY1612E	7,357.00	715
16X14	DFY1614E	8,541.00	755
16X16	DFY1616E	8,287.00	805
18X 6	DFY1806E	4,783.00	
18X 8	DFY1808E	6,644.00	780
18X10	DFY1810E	9,403.00	810
18X12	DFY1812E	9,879.00	850

Contd.....

CALL FOR BARE/BARE FITTINGS

**FLANGE LATERAL WYES**

Contd.....

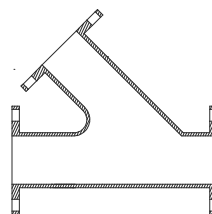

Size (in.)	Item No.	List Price (\$)	Wt. (lb.)
18X14	DFY1814E	10,358.00	885
18X16	DFY1816E	10,889.00	935
18X18	DFY1818E	10,411.00	1035
20X 8	DFY2008E	8,355.00	740
20X10	DFY2010E	9,093.00	1025
20X12	DFY2012E	12,536.00	1065
20X14	DFY2014E	13,720.00	1110
20X16	DFY2016E	14,337.00	1155
20X18	DFY2018E	13,548.00	1200
20X20	DFY2020E	14,284.00	1265
24X 6	DFY2406E	11,970.00	
24X 8	DFY2408E	12,192.00	1425
24X10	DFY2410E	16,991.00	1460
24X12	DFY2412E	13,548.00	1550
24X14	DFY2414E	19,752.00	1560
24X16	DFY2416E	21,332.00	1615
24X18	DFY2418E	20,944.00	1680
24X20	DFY2420E	19,752.00	1750
24X24	DFY2424E	21,505.00	1905
30X12	DFY3012E	33,416.00	2545
30X14	DFY3014E	34,075.00	2590
30X16	DFY3016E	34,730.00	2645
30X18	DFY3018E	35,385.00	2690
30X20	DFY3020E	36,340.00	2760
30X24	DFY3024E	38,316.00	2915
30X30	DFY3030E	38,557.00	3225
36X12	DFY3612E	53,676.00	4490
36X14	DFY3614E	54,333.00	4545
36X16	DFY3616E	53,260.00	4000
36X18	DFY3618E	55,827.00	4670

Size (in.)	Item No.	List Price (\$)	Wt. (lb.)
36X20	DFY3620E	54,692.00	4750
36X24	DFY3624E	56,486.00	4920
36X30	DFY3630E	62,158.00	5255
36X36	DFY3636E	68,612.00	5740
42X12	DFY4212E	72,263.00	5725
42X14	DFY4214E	73,210.00	5800
42X16	DFY4216E	73,840.00	5850
42X18	DFY4218E	75,735.00	6000
42X20	DFY4220E	77,124.00	6680
42X24	DFY4224E	78,956.00	6850
42X30	DFY4230E	86,528.00	7185
42X36	DFY4236E	96,562.00	7670
42X42	DFY4242E	1,15,745.00	9185
48X12	DFY4812E	90,881.00	7200
48X14	DFY4814E	91,829.00	7276
48X16	DFY4816E	93,404.00	7400
48X18	DFY4818E	96,180.00	7620
48X20	DFY4820E	97,001.00	7685
48X24	DFY4824E	86,336.00	8695
48X30	DFY4830E	1,01,168.00	5573
48X36	DFY4836E	1,13,218.00	9515
48X42	DFY4842E	1,38,968.00	11030
48X48	DFY4848E	1,52,722.00	12115
54X24	DFY5424E	POA	6220
54X30	DFY5430E	POA	7478
54X36	DFY5436E	POA	7600
54X42	DFY5442E	POA	8930
54X48	DFY5448E	POA	9480
54X54	DFY5454E	POA	11780
60X30	DFY6030E	POA	9045

**CALL FOR BARE/BARE FITTINGS**

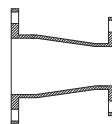
**CONCENTRIC REDUCER**

Size (in.)	Item No.	List Price (\$)	Wt. (lb.)
3 X 2	DFCR0302E	173.00	16
4 X 2	DFCR0402E	267.00	25
4 X 2.5	DFCR0402.5E	268.00	26
4 X 3	DFCR0403E	365.00	30
6 X 2	DFCR0602E	414.00	35
6 X 3	DFCR0603E	415.00	40
6 X 4	DFCR0604E	528.00	45
6 X 5	DFCR0605E	POA	52
8 X 3	DFCR0803E	625.00	60
8 X 4	DFCR0804E	726.00	65
8 X 5	DFCR0805E	679.00	70
8 X 6	DFCR0806E	886.00	75
10X 4	DFCR1004E	880.00	85
10X 6	DFCR1006E	1,102.00	90
10X 8	DFCR1008E	1,238.00	110
12X 4	DFCR1204E	1,298.00	120
12X 6	DFCR1206E	1,451.00	130
12X 8	DFCR1208E	1,645.00	145
12X10	DFCR1210E	1,602.00	170
14X 6	DFCR1406E	1,807.00	155
14X 8	DFCR1408E	1,989.00	175
14X10	DFCR1410E	1,942.00	190
14X12	DFCR1412E	1,961.00	248
16X 6	DFCR1606E	1,854.00	190
16X 8	DFCR1608E	2,084.00	210
16X10	DFCR1610E	2,674.00	235
16X12	DFCR1612E	2,887.00	265
16X14	DFCR1614E	2,554.00	280
18X 8	DFCR1808E	2,821.00	240
18X10	DFCR1810E	2,828.00	265
18X12	DFCR1812E	3,298.00	295
18X14	DFCR1814E	3,271.00	310
18X16	DFCR1816E	3,392.00	340
20X 6	DFCR2006E	3,224.00	

Size (in.)	Item No.	List Price (\$)	Wt. (lb.)
20X 8	DFCR2008E	3,506.00	
20X10	DFCR2010E	3,480.00	310
20X12	DFCR2012E	4,017.00	345
20X14	DFCR2014E	3,736.00	355
20X16	DFCR2016E	4,636.00	390
20X18	DFCR2018E	4,631.00	410
24X 8	DFCR2408E	5,310.00	410
24X10	DFCR2410E	5,767.00	
24X12	DFCR2412E	5,921.00	480
24X14	DFCR2414E	5,163.00	490
24X16	DFCR2416E	6,210.00	525
24X18	DFCR2418E	6,666.00	550
24X20	DFCR2420E	9,212.00	590
30X12	DFCR3012E	9,327.00	825
30X16	DFCR3016E	9,690.00	770
30X18	DFCR3018E	10,406.00	810
30X20	DFCR3020E	11,602.00	870
30X24	DFCR3024E	13,215.00	970
36X16	DFCR3616E	13,874.00	1105
36X18	DFCR3618E	14,707.00	
36X20	DFCR3620E	16,086.00	1230
36X24	DFCR3624E	18,595.00	1345
36X30	DFCR3630E	22,976.00	1555
42X24	DFCR4224E	26,002.00	1820
42X30	DFCR4230E	29,605.00	2060
42X36	DFCR4236E	29,476.00	2550
48X30	DFCR4830E	33,137.00	2625
48X36	DFCR4836E	37,239.00	2950
48X42	DFCR4842E	41,911.00	3320
54X30	DFCR5430E	POA	1625
54X36	DFCR5436E	POA	1680
54X42	DFCR5442E	POA	1800
54X48	DFCR5448E	POA	1695

CALL FOR BARE/BARE FITTINGS

**ECCENTRIC REDUCER**

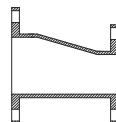

Size (in.)	Item No.	List Price (\$)	Wt. (lb.)
3 X 2	DFER0302E	173.00	16
4 X 2	DFER0402E	267.00	25
4 X 3	DFER0403E	317.00	30
6 X 2	DFER0602E	POA	35
6 X 3	DFER0603E	414.00	40
6 X 4	DFER0604E	474.00	45
6 X 5	DFER0605E	543.00	52
8 X 3	DFER0803E	POA	60
8 X 4	DFER0804E	678.00	65
8 X 5	DFER0805E	726.00	70
8 X 6	DFER0806E	779.00	75
10X 4	DFER1004E	886.00	85
10X 6	DFER1006E	931.00	90
10X 8	DFER1008E	1,138.00	110
12X 4	DFER1204E	1,238.00	120
12X 6	DFER1206E	1,343.00	130
12X 8	DFER1208E	1,498.00	145
12X10	DFER1210E	1,757.00	170
14X 6	DFER1406E	1,602.00	155
14X 8	DFER1408E	1,757.00	175
14X10	DFER1410E	1,961.00	190
14X12	DFER1412E	2,320.00	248
16X 6	DFER1606E	1,961.00	190
16X 8	DFER1608E	2,166.00	210
16X10	DFER1610E	2,424.00	235
16X12	DFER1612E	2,733.00	265
16X14	DFER1614E	2,887.00	280
18X 8	DFER1808E	2,554.00	240
18X10	DFER1810E	2,821.00	265
18X12	DFER1812E	3,142.00	295
18X14	DFER1814E	3,298.00	310
18X16	DFER1816E	3,614.00	340
20X 8	DFER2008E	3,277.00	
20X10	DFER2010E	3,506.00	310

Size (in.)	Item No.	List Price (\$)	Wt. (lb.)
20X12	DFER2012E	3,901.00	345
20X14	DFER2014E	4,017.00	355
20X16	DFER2016E	4,406.00	390
20X18	DFER2018E	4,631.00	410
24X 8	DFER2408E	5,196.00	
24X10	DFER2410E	5,310.00	
24X12	DFER2412E	5,422.00	480
24X14	DFER2414E	5,535.00	490
24X16	DFER2416E	5,934.00	525
24X18	DFER2418E	6,210.00	550
24X20	DFER2420E	6,666.00	590
30X10	DFER3010E	9,044.00	
30X14	DFER3014E	11,602.00	825
30X16	DFER3016E	11,185.00	770
30X18	DFER3018E	9,747.00	810
30X20	DFER3020E	10,406.00	870
30X24	DFER3024E	11,602.00	970
36X14	DFER3614E	15,426.00	1290
36X16	DFER3616E	13,335.00	1105
36X18	DFER3618E	13,874.00	
36X20	DFER3620E	14,650.00	1230
36X24	DFER3624E	16,021.00	1345
36X30	DFER3630E	18,535.00	1555
42X24	DFER4224E	22,976.00	1820
42X30	DFER4230E	26,002.00	2060
42X36	DFER4236E	29,605.00	2550
48X24	DFER4824E	31,551.00	
48X30	DFER4830E	33,137.00	2625
48X36	DFER4836E	37,239.00	2950
48X42	DFER4842E	41,911.00	3320
54X30	DFER5430E	POA	1625
54X36	DFER5436E	POA	1680
54X42	DFER5442E	POA	1800
54X48	DFER5448E	POA	1695

CALL FOR BARE/BARE FITTINGS

**BLIND FLANGES**

Size (in.)	Item No.	List Price (\$)	Wt. (lb.)
2	DBF02E	POA	9
3	DBF03E	101.00	9
4	DBF04E	174.00	16
6	DBF06E	264.00	25
8	DBF08E	439.00	42
10	DBF10E	656.00	63
12	DBF12E	880.00	85
14	DBF14E	1,237.00	120
16	DBF16E	1,498.00	145
18	DBF18E	2,074.00	195
20	DBF20E	2,766.00	245
24	DBF24E	4,113.00	370
30	DBF30E	5,974.00	500
36	DBF36E	11,460.00	960
42	DBF42E	16,382.00	1300
48	DBF48E	21,925.00	1740
54	DBF54E	POA	2600

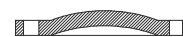
**2" TAPPED  
BLIND FLANGES**

Size (in.)	Item No.	List Price (\$)	Wt. (lb.)
3	DBFT03E	167.00	9
4	DBFT04E	238.00	16
6	DBFT06E	327.00	25
8	DBFT08E	501.00	42
10	DBFT10E	720.00	63
12	DBFT12E	946.00	85
14	DBFT14E	1,341.00	120
16	DBFT16E	1,605.00	145
18	DBFT18E	2,209.00	195
20	DBFT20E	2,900.00	245
24	DBFT24E	4,248.00	370
30	DBFT30E	6,174.00	500
36	DBFT36E	11,661.00	960
42	DBFT42E	16,648.00	1300
48	DBFT48E	22,191.00	1740
54	DBFT54E	POA	2600

CALL FOR BARE/BARE FITTINGS







# SIP Industries

Quality Manufacturers Since 1960



## PRODUCT LINE

### AWWA DI Fittings & Accessories

- C153 Compact MJ Fittings and Acc. 2" - 64"
- C110 Full Body MJ Fittings 2" - 64"
- C153 Trim Tyton® Push-On Fittings 4" - 24"
- C110 Flange Fittings 2" - 64"
- MJ x MJ Adapter for Connecting MJ Bells 3" - 24"
- Stainless Steel & Blue T-Bolts
- Made in India, China & Mexico
- Bare, Cement, Zinc, FBE & Other Linings

### Joint Restraint System

- EZD Joint Restraint for DI Pipe 3" - 48"
- EZDTP Joint Restraint Tandem for DI Pipe 3" - 48"
- EZDPTP Joint Restraint for Push-On Joints DI Pipe 3" - 48"
- Ductile Iron Retainer Glands 3" - 30"
- FAR / FAH Flange Adapter for DI Pipe 3" - 48"
- EZFA Restrained Flange Adapter for DI and PVC Pipe 3" - 36"
- EZPVC Joint Restraint for PVC Pipe 3" - 36"
- ULTRA Joint Restraint for PVC Pipe 4" - 12"
- EZPVCPTP Joint Restraint for Push-On Joints PVC Pipe 14" - 36"
- PTPVC Pipe to Pipe Restraint 4" - 48"
- PTPDF Pipe to MJ Fittings Restraint 4" - 48"
- PTPFC Pipe to PVC Fittings Restraint 4" - 12"
- Made in China & USA
- EZ Shield or Shop Coating

### Municipal Construction Castings

- Manhole Rings and Cover
- Frames and Grates
- Valve Boxes and Service Boxes
- Water Meter Covers and Boxes
- Cleanout and Monument Boxes
- Detectable Warning Plates
- Extension Rings
- Trench Grates and Tree Grates
- Made in India & USA

### Fabrication Products for DI Pipe

- High Hub Flanges Class 150 and 250. 3" - 64"
- Threaded Bell Flanges 3" - 48"
- Anchor Flanges 3" - 60"
- Filler Flanges 4" - 30"

### Other Products and Services

- All Thread Rod
- Pipe Lube and Hydraulic Cement
- Socket Clamps and Lugs
- Flange Packs
- OEM Castings



**SIP CORPORATE** 8876 Gulf Freeway, Suite 500, Houston, TX 77017

**SIP CENTRAL** 2900 Patio Drive, Houston, TX 77017

**SIP EAST** 600 Rayloc Drive, Atlanta, GA 30336

**SIP WEST** 8333 Almeria Avenue, Fontana, CA 92335

Phone: 877-921-6111 or 713-923-6111 | Fax: 713-923-6114 | [www.sipindustries.com](http://www.sipindustries.com) | [sales@sipindustries.com](mailto:sales@sipindustries.com)