

60+
YEARS OF SERVICE

★★★
SIP INDUSTRIES
SERAMPORE
SINCE 1960

SIP Industries



Quality Manufacturers Since 1960

Utility Pipe Fittings

PRICE LIST

Effective : December 16, 2024

www.sipindustries.com

Toll Free 877-921-6111



TABLE OF CONTENTS

GENERAL TERMS & CONDITIONS..... Page : P002 - P004

COMPACT MJ FITTINGS
ANSI/AWWA C153/A21.53..... Page : P005 - P020

FULL BODY MJ FITTINGS
ANSI/AWWA C110/A21.10..... Page : P021 - P034

COMPACT PUSH-ON FITTINGS
ANSI/AWWA C153/A21.53..... Page : P035 - P042

FLANGE FITTINGS
ANSI/AWWA C110/A21.10..... Page : P043 - P056

- All dimensions are in inches unless noted otherwise.
- All weights are approximate in pounds unless noted otherwise.
- POA = Price on availability.
- R = Available multiple size reductions.

SIP INDUSTRIES

GENERAL TERMS AND CONDITIONS OF SALE

1. Acceptance. All sales by SIP Industries (Seller) are made pursuant to these Terms and Conditions. Submission of a purchase order to Seller, and/or acceptance of goods delivered by Seller, shall be deemed an acceptance of these Terms and Conditions by Purchaser. Please note that these Terms and Conditions may be modified from time to time; the applicable Terms and Conditions are those posted on SIP's website, www.sipindustries.com, at the time that a purchase order is accepted or an agreement otherwise confirmed. Purchaser's alteration or addition to these Terms and Conditions, as same may be in effect from time to time, is expressly rejected unless accepted in writing by an authorized representative of Seller.

2. Entire Agreement. These Terms and Conditions, together with Seller's price list and Purchaser's purchase order, when accepted by Seller, shall be the entire agreement between Seller and Purchaser. Neither Seller nor Purchaser is relying on any representations, warranties or agreements except as expressly provided in these Terms and Conditions and in an accepted purchase order. To the extent of any conflict between the terms of a purchase order or any other documents submitted by Purchaser, on the one hand, and these Terms and Conditions, on the other, these Terms and Conditions shall govern.

3. Prices. Prices and descriptions of goods stated in Seller's price lists are subject to change without notice. Prices are subject to tariffs, raw material surcharges, labor disputes and shipping surcharges. To submit a purchase order, SIP Industries item numbers and part codes should be included. Seller's quotations are on globally sourced products unless otherwise noted. The ordering party is responsible to specify any required origin as required for end use. Quotations, if provided by Seller, expire sixty (60) days from the date provided unless otherwise agreed in writing.

4. Terms. Invoices are due and payable thirty (30) days from date of shipment, unless otherwise written on the invoice or confirmed in writing by Seller. A five percent (5%) late fee will be charged on all past-due accounts. If it becomes necessary to retain attorneys to collect an account, the Purchaser is liable for Seller's attorney's fees and other costs of collection.

5. FOB point of shipment. All prices are FOB point of shipment, unless otherwise agreed in writing. Seller's responsibility for goods therefore ceases and title passes to the Purchaser at the point of shipment; all claims for damages or losses in transit must be directed to the carrier with copy to Seller within ten (10) days of shipment.

6. Delivery. Seller shall have the right to select the freight carrier unless otherwise agreed. Seller has the right to substitute material with same function and design to accommodate unforeseen delays, shortages or restrictions.

7. Cancellations, Changes and Returns. All cancellations, changes and returns must be accepted in writing by an authorized representative of Seller, otherwise they will not be valid and binding on Seller. Seller will not be responsible for unauthorized returned product. It will be the responsibility of purchaser at their expense to have unauthorized product returned or disposed of. Seller shall not be obligated to accept any cancellation, change or return, but if it does so the following terms shall apply: (i) goods must be returned to Seller's facility, in the same condition in which they were accepted by Purchaser; (ii) a handling charge of thirty-five percent (35%) of the purchase price will be deducted from the credit given to Purchaser; and (iii) shipping charges, if not prepaid by Purchaser, will likewise be deducted from the credit given to Purchaser.

8. Specially Manufactured Goods. Unless otherwise agreed, specially-manufactured goods, including goods designed to the Purchaser's specifications, may not be cancelled or returned once work has begun to design or manufacture the goods unless an agreement is reached and confirmed in writing by Seller, including compensation to Seller for work thus far done with respect to the goods.

9. Delays; Force Majeure. Seller shall not be liable for any expenses, loss or damage resulting from any delay in delivery of goods or other failure of Seller's performance due to fire, floods, acts of god, strikes, labor disputes, labor shortages, riots, accidents, transportation delays or other causes beyond the reasonable control of Seller.

10. Disclaimer regarding weights. All stated weights are approximate and are given for inventory and shipping purposes only.

11. Taxes. Seller's prices do not include sales, excise or other taxes. Purchaser shall pay all such taxes. If Purchaser claims a tax exemption, Purchaser shall provide Seller with the necessary tax-exemption numbers and certificates. If Purchaser aims a tax exemption, Purchaser shall provide Seller with the necessary tax-exemption numbers and certificates. If Seller accepts an exemption but is later required by the taxing authority to pay taxes, Purchaser shall reimburse to Seller the amount of such taxes.

12. Limited Warranty. For a period of one calendar year from the date of shipment, Seller warrants that goods sold and delivered by Seller to Purchaser will conform to the number and type of goods described in the accepted purchase order and that such goods will be free from defects in material and workmanship.

THIS LIMITED WARRANTY IS SELLER'S SOLE AND EXCLUSIVE WARRANTY. SELLER MAKES NO OTHER WARRANTY OF ANY KIND, EXPRESS OR IMPLIED. SELLER DOES NOT WARRANT THAT THE GOODS ARE FIT FOR ANY PARTICULAR PURPOSE. SELLER DOES NOT WARRANT THAT THE GOODS ARE MERCHANTABILITY.

13. Product Disclaimers. All tooling required to manufacture products are the property of Seller even if tooling costs are incurred by Purchaser. Seller has the right to change product design, engineering, materials, tooling and processes that do not affect the intended use and application of the product. Seller will notify Purchaser if changes are substantial and may affect the application or appearance of the product. Furthermore, references to Buyer's specifications and similar requirements are only to describe the goods and do not give rise to any representation, warranty or other sales term.

Seller manufactures to industry standards and makes every effort to address applications of its products. Please see current technical advisory at Seller's web site, sipindustries.com, for up to date product support and recommendations. All product dimension, designs, technology, tooling, process, software, innovations, and drawings are considered intellectual property and are owned and confidential to Seller. Purchaser has no rights or privileges to SIP industries intellectual property including product applications without Seller's express written consent.

14. Prompt notice required for Limited Warranty claims. Buyer is responsible for promptly inspecting goods on delivery and notifying Seller, within sixty (60) days of delivery to Buyer, of any nonconformity or defect that would be discovered on a reasonable and customary inspection. Provided that such notice is given and that the warranty claim is made within one year, Seller will provide a replacement or price adjustment, in Seller's discretion, not to exceed the net sales price of the defective product. However, this warranty shall be of no force or effect absent such timely notice. Seller shall not in any event be responsible for labor, removal or installation charges incurred in connection with the replacement of defective goods.

15. Conditions to Limited Warranty. Purchaser shall notify Seller immediately upon discovery of a defect so that Seller may inspect the product in its installed condition. Seller shall not be responsible for defects or failures in goods of which it is not so notified; nor shall Seller be responsible for goods manufactured or sold by other parties or losses or impairments caused by such goods; nor shall Seller be responsible for defects or failure of goods due to improper installation, improper usage, normal or abnormal wear and tear, erosion or corrosion, improper storage, use or maintenance, vandalism, vehicular or other accidents, or storms or other forces beyond the control of the parties. Seller also shall not be responsible for goods that have been damaged by misuse, negligence or accident or that have been altered or repaired by any party other than Seller.

16. Limitation on Liability. In the event any remedy hereunder fails of its essential purpose and monetary damages may be imposed, Seller's liability, whether founded in contract or tort (including negligence), arising out of or resulting from (i) the Purchase Order and resulting contract or the performance or breach thereof, or (ii) the design, manufacture, delivery, sale, repair, replacement or use of the goods, shall not exceed the cost of the goods at issue in the claim. NOTWITHSTANDING ANYTHING CONTAINED HEREIN TO THE CONTRARY, SELLER SHALL NOT BE LIABLE TO PURCHASER OR ANY OTHER PERSON FOR CONSEQUENTIAL, INCIDENTAL, SPECIAL, EXEMPLARY, PUNITIVE OR OTHER INDIRECT DAMAGES, INCLUDING, WITHOUT LIMITATION, LOSS OF PROFITS, RECALL-RELATED EXPENSES, AND LOSS OF USE OF THE GOODS.

17. Purchaser specifications. If Seller has designed the goods using information provided by Purchaser, Seller shall not be responsible for design errors resulting from inaccurate or incomplete information supplied by Purchaser. If

Purchaser has provided specifications or a model or sample from which a good is designed and manufactured, Seller shall not be responsible for any defect, error or inadequacy provided that the good is designed or manufactured in compliance with Purchaser's specifications, model or sample.

18. Solvency and Security Interest. By submitting a Purchase Order, Buyer represents to Seller that Buyer is solvent and capable of timely fulfilling its payment and other obligations to Seller. Until the goods and any other indebtedness of Buyer have been paid in full, Buyer, its agents any successors: (i) will hold the goods subject to a security interest in favor of Seller allowing for the right or re-possession by Seller to the extent permitted by applicable law, (ii) will not alter, remove, destroy, or damage any identifying mark on the goods or their packaging, and (iii) will keep the goods separate from any other products.

19. Governing law; venue. All sales shall be governed by the law of the state of Texas. In the event that a lawsuit is filed between the parties on any claim arising out of or in connection with such sales, Seller and Purchaser agree that exclusive venue and jurisdiction shall be in the state or federal courts of Harris County, Texas.

20. Attorney's fees and costs. In the event of litigation between the parties with respect to the sale of goods, the prevailing party shall be entitled to recover its reasonable attorney's fees and costs, including expert witness fees.

Utility Pipe Fittings & Accessories

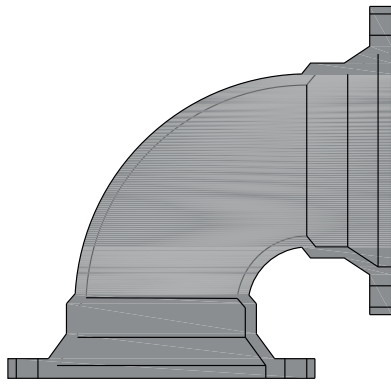

ANSI/AWWA C153/A21.53
COMPACT MJ FITTINGS

PRICE LIST

Effective December 16, 2024



**BENDS : MJ X MJ
90° (1/4)**

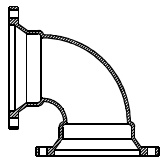

Size (in.)	Item No.	Crt. Qty.	List Price (\$)	Wt. (lb.)
2	CDMJB9002	36	POA	14
3	CDMJB9003	80	128.00	23
4	CDMJB9004	60	139.00	27
6	CDMJB9006	36	227.00	39
8	CDMJB9008	18	327.00	57
10	CDMJB9010	12	518.00	89
12	CDMJB9012	8	697.00	108
14	CDMJB9014	4	1,162.00	210
16	CDMJB9016	2	1,577.00	264
18	CDMJB9018		1,959.00	335
20	CDMJB9020		2,730.00	400
24	CDMJB9024		4,075.00	565
30	CDMJB9030		6,537.00	960
36	CDMJB9036		10,218.00	1499
42	CDMJB9042		17,520.00	2205
48	CDMJB9048		23,359.00	2990

**BENDS :MJ X MJ
45° (1/8)**

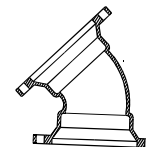

Size (in.)	Item No.	Crt. Qty.	List Price (\$)	Wt. (lb.)
2	CDMJB4502	36	POA	13
3	CDMJB4503	80	116.00	21
4	CDMJB4504	100	116.00	23
6	CDMJB4506	48	184.00	32
8	CDMJB4508	27	268.00	46
10	CDMJB4510	18	386.00	70
12	CDMJB4512	12	577.00	86
14	CDMJB4514	8	904.00	164
16	CDMJB4516	8	1,128.00	202
18	CDMJB4518	2	1,669.00	250
20	CDMJB4520		1,780.00	305
24	CDMJB4524		2,704.00	405
30	CDMJB4530		5,493.00	783
36	CDMJB4536		8,030.00	1142
42	CDMJB4542		12,333.00	1610
48	CDMJB4548		16,158.00	2090

**BENDS : MJ X MJ
22½° (1/16)**

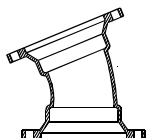

Size (in.)	Item No.	Crt. Qty.	List Price (\$)	Wt. (lb.)
2	CDMJB2202	50	132.00	9
3	CDMJB2203	50	73.00	16
4	CDMJB2204	100	109.00	18
6	CDMJB2206	48	167.00	32
8	CDMJB2208	27	261.00	46
10	CDMJB2210	18	385.00	64
12	CDMJB2212	12	504.00	84
14	CDMJB2214	8	916.00	148
16	CDMJB2216	8	1,082.00	178
18	CDMJB2218	2	1,371.00	255
20	CDMJB2220	2	1,860.00	310
24	CDMJB2224	2	2,497.00	412
30	CDMJB2230		4,602.00	796
36	CDMJB2236		6,744.00	1160
42	CDMJB2242		10,179.00	1350
48	CDMJB2248		13,256.00	1760

**BENDS : MJ X MJ
11¼° (1/32)**



Size (in.)	Item No.	Crt. Qty.	List Price (\$)	Wt. (lb.)
2	CDMJB1102	30	162.00	8
3	CDMJB1103	30	84.00	14
4	CDMJB1104	50	105.00	16
6	CDMJB1106	60	175.00	30
8	CDMJB1108	27	237.00	42
10	CDMJB1110	18	383.00	58
12	CDMJB1112	16	473.00	74
14	CDMJB1114	8	1,045.00	130
16	CDMJB1116	4	1,144.00	158
18	CDMJB1118	2	1,730.00	205
20	CDMJB1120	2	1,752.00	245
24	CDMJB1124	2	2,339.00	315
30	CDMJB1130		4,686.00	800
36	CDMJB1136		6,403.00	1165
42	CDMJB1142		9,717.00	1180
48	CDMJB1148		13,164.00	1475

CALL FOR BARE/BARE FITTINGS

* AWWA C110

BENDS : MJ X PE
90° (1/4)

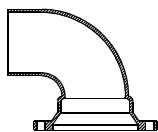

Size (in.)	Item No.	Crt. Qty.	List Price (\$)	Wt. (lb.)
3	CDMJPB9003	72	126.00	16
4	CDMJPB9004	60	165.00	22
6	CDMJPB9006	36	272.00	41
8	CDMJPB9008	9	386.00	61
10	CDMJPB9010	12	605.00	83
12	CDMJPB9012	8	789.00	114
14	CDMJPB9014	4	1,365.00	197
16	CDMJPB9016	4	2,092.00	248
18	CDMJPB9018		3,740.00	325
20	CDMJPB9020		4,184.00	390
24	CDMJPB9024		4,491.00	575
30	CDMJPB9030		7,237.00	945
36	CDMJPB9036		16,290.00	1360
42	CDMJPB9042		16,473.00	2062
48	CDMJPB9048		31,544.00	

BENDS : MJ X PE
45° (1/8)

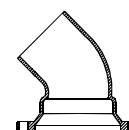

Size (in.)	Item No.	Crt. Qty.	List Price (\$)	Wt. (lb.)
3	CDMJPB4503	100	108.00	13
4	CDMJPB4504	100	122.00	19
6	CDMJPB4506	24	206.00	34
8	CDMJPB4508	24	325.00	49
10	CDMJPB4510	18	480.00	72
12	CDMJPB4512	12	683.00	98
14	CDMJPB4514	8	1,109.00	148
16	CDMJPB4516	8	1,275.00	184
18	CDMJPB4518	2	3,091.00	235
20	CDMJPB4520		3,143.00	290
24	CDMJPB4524		3,047.00	390
30	CDMJPB4530		5,985.00	772
36	CDMJPB4536		14,865.00	1460
42	CDMJPB4542		15,281.00	2055
48	CDMJPB4548		19,301.00	2235

BENDS : MJ X PE
22½° (1/16)

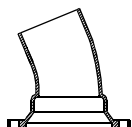

Size (in.)	Item No.	Crt. Qty.	List Price (\$)	Wt. (lb.)
3	CDMJPB2203	100	93.00	12
4	CDMJPB2204	100	125.00	18
6	CDMJPB2206	48	213.00	29
8	CDMJPB2208		325.00	43
10	CDMJPB2210	18	434.00	61
12	CDMJPB2212	12	573.00	81
14	CDMJPB2214	8	1,149.00	133
16	CDMJPB2216	8	1,767.00	166
18	CDMJPB2218		2,066.00	235
20	CDMJPB2220		2,954.00	300
24	CDMJPB2224		4,187.00	395
30	CDMJPB2230		5,018.00	600
36	CDMJPB2236		POA	874
42	CDMJPB2242		POA	1215
48	CDMJPB2248		POA	

BENDS : MJ X PE
11¼° (1/32)

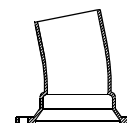

Size (in.)	Item No.	Crt. Qty.	List Price (\$)	Wt. (lb.)
3	CDMJPB1103	100	93.00	12
4	CDMJPB1104	100	121.00	17
6	CDMJPB1106	48	198.00	27
8	CDMJPB1108		306.00	39
10	CDMJPB1110	18	386.00	52
12	CDMJPB1112	12	497.00	70
14	CDMJPB1114	8	926.00	122
16	CDMJPB1116	8	1,145.00	148
18	CDMJPB1118		2,066.00	235
20	CDMJPB1120		2,954.00	300
24	CDMJPB1124		4,187.00	400
30	CDMJPB1130		10,492.00	562
42	CDMJPB1142		20,418.00	

* AWWA C110

BENDS : MJ X FE
90° (1/4)

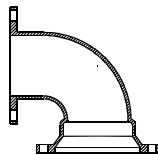

Size (in.)	Item No.	Crt. Qty.	List Price (\$)	Wt. (lb.)
3	CDMJFB9003	72	140.00	20
4	CDMJFB9004	48	159.00	26
6	CDMJFB9006	27	278.00	47
8	CDMJFB9008	18	483.00	68
10	CDMJFB9010	12	787.00	102
12	CDMJFB9012	8	1,131.00	134
14	CDMJFB9014	4	1,905.00	223
16	CDMJFB9016	4	2,319.00	303
24	CDMJFB9024		6,629.00	617
30	CDMJFB9030		11,628.00	1014

BENDS : MJ X FE
45° (1/8)

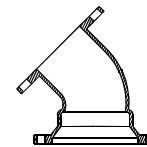

Size (in.)	Item No.	Crt. Qty.	List Price (\$)	Wt. (lb.)
3	CDMJFB4503	32	166.00	17
4	CDMJFB4504	100	172.00	24
6	CDMJFB4506	48	251.00	39
8	CDMJFB4508	27	480.00	57
10	CDMJFB4510	18	704.00	83
12	CDMJFB4512	12	1,050.00	111
14	CDMJFB4514	8	1,571.00	208
16	CDMJFB4516	8	2,155.00	240
24	CDMJFB4524		4,744.00	617
30	CDMJFB4530		20,744.00	1014

BENDS : MJ X FE
22½° (1/16)

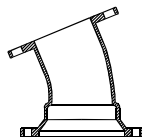

Size (in.)	Item No.	Crt. Qty.	List Price (\$)	Wt. (lb.)
3	CDMJFB2203	24	288.00	18
4	CDMJFB2204	100	220.00	27
6	CDMJFB2206	48	282.00	36
8	CDMJFB2208	27	434.00	53
10	CDMJFB2210	18	631.00	100
12	CDMJFB2212	12	918.00	145
30	CDMJFB2230		19,384.00	

BENDS : MJ X FE
11¼° (1/32)

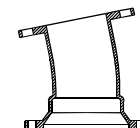

Size (in.)	Item No.	Crt. Qty.	List Price (\$)	Wt. (lb.)
4	CDMJFB1104	100	193.00	20
6	CDMJFB1106	48	272.00	30
8	CDMJFB1108	27	359.00	50
10	CDMJFB1110	18	605.00	74
12	CDMJFB1112	12	789.00	85

TEES : MJ X MJ

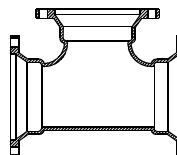

Size (in.)	Item No.	Crt. Qty.	List Price (\$)	Wt. (lb.)
2 X 2	CDMJT0202		POA	22
3 X 2	CDMJT0302		306.00	43
3 X 3	CDMJT0303	50	171.00	28
4 X 2	CDMJT0402	36	272.00	29
4 X 3	CDMJT0403	16	207.00	35
4 X 4	CDMJT0404	60	182.00	32
6 X 3	CDMJT0603	12	250.00	42
6 X 4	CDMJT0604	36	302.00	46

Size (in.)	Item No.	Crt. Qty.	List Price (\$)	Wt. (lb.)
6 X 4 X 6	CDMJT060406	12	727.00	60
6 X 6	CDMJT0606	24	325.00	56
6 X 6 X 8	CDMJT060608	25	637.00	75
8 X 3	CDMJT0803	9	396.00	52
8 X 4	CDMJT0804	27	351.00	60
8 X 6	CDMJT0806	18	403.00	72
8 X 6 X 6	CDMJT080606	9	1,016.00	75
8 X 6 X 8	CDMJT080608	9	1,016.00	85

CALL FOR BARE/BARE FITTINGS

* AWWA C110

Contd.....

TEES : MJ X MJ
Contd.....

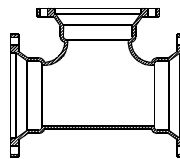

Size (in.)	Item No.	Crt. Qty.	List Price (\$)	Wt. (lb.)
8 X 8	CDMJT0808	18	487.00	86
10X 3	CDMJT1003	6	516.00	75
10X 4	CDMJT1004	18	536.00	78
10X 6	CDMJT1006	12	520.00	90
10X 8	CDMJT1008	12	608.00	105
10X10	CDMJT1010	12	694.00	120
12X 3	CDMJT1203		702.00	90
12X 4	CDMJT1204	12	657.00	94
12X 6	CDMJT1206	8	657.00	110
12X 8	CDMJT1208	8	756.00	125
12X10	CDMJT1210	8	972.00	140
12X12	CDMJT1212	8	968.00	160
14X 6	CDMJT1406	8	1,046.00	182
14X 8	CDMJT1408	8	1,185.00	206
14X10	CDMJT1410	8	1,579.00	228
14X12	CDMJT1412	4	1,696.00	234
14X14	CDMJT1414	4	1,606.00	280
16X 4	CDMJT1604		2,485.00	
16X 6	CDMJT1606	4	1,349.00	228
16X 8	CDMJT1608	4	1,465.00	248
16X10	CDMJT1610	2	1,937.00	264
16X12	CDMJT1612	4	1,751.00	280
16X14	CDMJT1614	4	2,390.00	316
16X16	CDMJT1616	4	2,210.00	322
18X 4	CDMJT1804		3,571.00	
18X 6	CDMJT1806		1,971.00	287
18X 8	CDMJT1808		2,136.00	295
18X10	CDMJT1810		2,182.00	325
18X12	CDMJT1812		2,532.00	340
18X14	CDMJT1814		3,275.00	380
18X16	CDMJT1816		3,420.00	425
18X18	CDMJT1818		3,298.00	450
20X 6	CDMJT2006		2,217.00	320
20X 8	CDMJT2008		2,267.00	366
20X10	CDMJT2010		3,068.00	370
20X12	CDMJT2012		2,805.00	395
20X14	CDMJT2014		3,505.00	475
20X16	CDMJT2016		2,761.00	505
20X18	CDMJT2018		4,506.00	505
20X20	CDMJT2020		3,040.00	550

Size (in.)	Item No.	Crt. Qty.	List Price (\$)	Wt. (lb.)
24X 6	CDMJT2406		2,668.00	415
24X 8	CDMJT2408		2,700.00	445
24X10	CDMJT2410		3,625.00	470
24X12	CDMJT2412		3,137.00	500
24X14	CDMJT2414		4,296.00	550
24X16	CDMJT2416		3,949.00	580
24X18	CDMJT2418		4,562.00	625
24X20	CDMJT2420		5,064.00	660
24X24	CDMJT2424		4,510.00	720
30X 4	CDMJT3004		6,985.00	
30X 6	CDMJT3006		4,530.00	742
30X 8	CDMJT3008		5,112.00	755
30X10	CDMJT3010		9,023.00	
30X12	CDMJT3012		5,740.00	817
30X16	CDMJT3016		6,631.00	931
30X18	CDMJT3018		9,938.00	1085
30X20	CDMJT3020		7,014.00	995
30X24	CDMJT3024		7,333.00	1389
30X30	CDMJT3030		9,453.00	1318
36X 6	CDMJT3606		9,201.00	1000
36X 8	CDMJT3608		8,786.00	1050
36X10	CDMJT3610		7,629.00	
36X12	CDMJT3612		7,629.00	1150
36X16	CDMJT3616		8,233.00	1167
36X18	CDMJT3618		15,194.00	1505
36X20	CDMJT3620		15,194.00	1520
36X24	CDMJT3624		10,407.00	1498
36X30	CDMJT3630		11,584.00	2381
36X36	CDMJT3636		13,716.00	2065
42X 6	CDMJT4206		18,210.00	1800
42X 8	CDMJT4208		17,612.00	
42X12	CDMJT4212		19,618.00	1950
42X16	CDMJT4216		18,193.00	2040
42X18	CDMJT4218		21,093.00	2195
42X20	CDMJT4220		21,093.00	2235
42X24	CDMJT4224		16,886.00	2270
42X30	CDMJT4230		17,196.00	2608
42X36	CDMJT4236		21,978.00	3000
42X42	CDMJT4242		23,309.00	3175
48X 6	CDMJT4806		30,295.00	2155

* AWWA C110

Contd.....

CALL FOR BARE/BARE FITTINGS

TEES : MJ X MJ

Contd.....

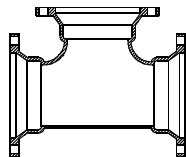

Size (in.)	Item No.	Crt. Qty.	List Price (\$)	Wt. (lb.)
48X 8	CDMJT4808		31,647.00	
48X12	CDMJT4812		22,293.00	2130
48X16	CDMJT4816		30,200.00	2650
48X18	CDMJT4818		30,200.00	
48X20	CDMJT4820		30,200.00	2500
48X24	CDMJT4824		20,763.00	2870
48X30	CDMJT4830		36,885.00	3050
48X36	CDMJT4836		29,291.00	3900
48X42	CDMJT4842		37,132.00	4100
48X48	CDMJT4848		31,274.00	4250

MJ X SWIVEL HYDRANT TEE (W/SWIVEL GLAND) ANCHOR TEE

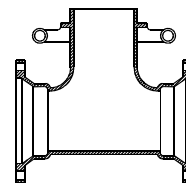

Size (in.)	Item No.	Crt. Qty.	List Price (\$)	Wt. (lb.)
6 X 6	CDMJHT0606	24	374.00	66
8 X 6	CDMJHT0806	18	469.00	86
8 X 8	CDMJHT0808	16	709.00	105
10X 6	CDMJHT1006	12	593.00	110
10X 8	CDMJHT1008	4	787.00	120
12X 6	CDMJHT1206	8	674.00	128
12X 8	CDMJHT1208	4	1,007.00	130
14X 6	CDMJHT1406	8	1,587.00	211
16X 6	CDMJHT1606	4	1,198.00	280
16X 8	CDMJHT1608	4	3,118.00	296
18X 6	CDMJHT1806		2,145.00	280
20X 6	CDMJHT2006		2,128.00	360
24X 6	CDMJHT2406		3,080.00	465
30X 6	CDMJHT3006		10,394.00	
36X 6	CDMJHT3606		11,190.00	

TEES : MJ X FE

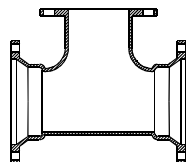

Size (in.)	Item No.	Crt. Qty.	List Price (\$)	Wt. (lb.)
3 X 3	CDMJFT0303	40	223.00	30
4 X 3	CDMJFT0403	16	251.00	34
4 X 4	CDMJFT0404	36	237.00	38
6 X 3	CDMJFT0603	12	359.00	51
6 X 4	CDMJFT0604	36	374.00	54
6 X 6	CDMJFT0606	24	374.00	62
8 X 3	CDMJFT0803		680.00	
8 X 4	CDMJFT0804	27	436.00	79
8 X 6	CDMJFT0806	18	452.00	80
8 X 8	CDMJFT0808	18	577.00	90
10X 4	CDMJFT1004	6	619.00	89
10X 6	CDMJFT1006	8	769.00	110
10X 8	CDMJFT1008	6	828.00	115
10X10	CDMJFT1010	4	1,053.00	130
12X 4	CDMJFT1204	8	820.00	117
12X 6	CDMJFT1206	8	865.00	133
12X 8	CDMJFT1208	8	960.00	135
12X10	CDMJFT1210	4	1,096.00	150
12X12	CDMJFT1212	4	1,376.00	170
14X 6	CDMJFT1406	8	1,400.00	185
14X 8	CDMJFT1408		POA	225
14X10	CDMJFT1410	8	2,008.00	244

Size (in.)	Item No.	Crt. Qty.	List Price (\$)	Wt. (lb.)
14X12	CDMJFT1412	8	2,179.00	284
14X14	CDMJFT1414	8	2,340.00	305
16X 6	CDMJFT1606	2	1,579.00	210
16X 8	CDMJFT1608	2	1,915.00	260
16X10	CDMJFT1610	4	2,283.00	287
16X12	CDMJFT1612	4	2,353.00	312
16X14	CDMJFT1614	4	POA	348
16X16	CDMJFT1616	4	3,251.00	374
18X 6	CDMJFT1806	4	1,993.00	320
18X 8	CDMJFT1808	4	2,596.00	352
18X12	CDMJFT1812		POA	358
18X16	CDMJFT1816		POA	558
18X18	CDMJFT1818		8,826.00	445
20X 6	CDMJFT2006	4	2,775.00	362
20X 8	CDMJFT2008		6,700.00	384
20X10	CDMJFT2010		POA	391
24X 6	CDMJFT2406	2	3,172.00	408
24X 8	CDMJFT2408		3,689.00	472
24X10	CDMJFT2410		6,963.00	586
24X12	CDMJFT2412	2	4,469.00	580
24X16	CDMJFT2416	2	5,621.00	745
24X24	CDMJFT2424		7,206.00	923

CALL FOR BARE/BARE FITTINGS

* AWWA C110

Contd.....

TEES : MJ X FE

Contd.....

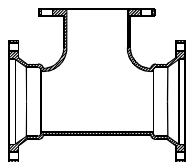

Size (in.)	Item No.	Crt. Qty.	List Price (\$)	Wt. (lb.)
30X 6	CDMJFT3006		6,733.00	805
30X 8	CDMJFT3008		POA	695
30X12	CDMJFT3012		9,008.00	715
30X16	CDMJFT3016		POA	1187
36X 6	CDMJFT3606		11,791.00	1175
36X12	CDMJFT3612		12,143.00	
36X16	CDMJFT3616		POA	1475
36X24	CDMJFT3624		23,117.00	
42X12	CDMJFT4212		26,071.00	
42X30	CDMJFT4230		28,342.00	

TEES : MJ TAPPED 2"

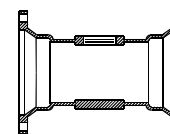

Size (in.)	Item No.	Crt. Qty.	List Price (\$)	Wt. (lb.)
3	CDMJTT0303	48	209.00	18
4	CDMJTT0404	48	234.00	25
6	CDMJTT0606	48	273.00	35
8	CDMJTT0808	36	453.00	55
10	CDMJTT1010	18	972.00	70
12	CDMJTT1212	8	1,219.00	85
16	CDMJTT1616		1,316.00	164

TEES : MJ X PE X MJ

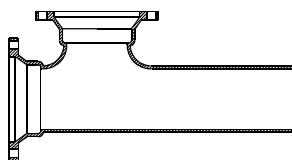

Size (in.)	Item No.	Crt. Qty.	List Price (\$)	Wt. (lb.)
6	CDMJPEMJT06		373.00	57
8 X 6	CDMJPEMJT0806		493.00	69
8	CDMJPEMJT08	9	565.00	77
10	CDMJPEMJT10		859.00	120
12	CDMJPEMJT12		1,288.00	168

TEES : MJ TANGENTIAL

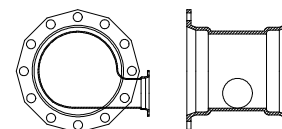

Size (in.)	Item No.	Crt. Qty.	List Price (\$)	Wt. (lb.)
16 X 6	CDMJTLT1606		POA	270
16 X12	CDMJTLT1612		POA	344
18 X 6	CDMJTLT1806		POA	306
24 X 6	CDMJTLT2406		POA	375
24 X 12	CDMJTLT2412		POA	450

CROSSES : MJ X MJ

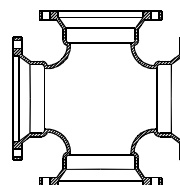

Size (in.)	Item No.	Crt. Qty.	List Price (\$)	Wt. (lb.)
3 X 3	CDMJX0303		229.00	40
4 X 3	CDMJX0403		272.00	49
4 X 4	CDMJX0404	12	386.00	42
6 X 4	CDMJX0604	6	423.00	68
6 X 6	CDMJX0606	16	473.00	80
8 X 4	CDMJX0804	6	666.00	100
8 X 6	CDMJX0806	12	491.00	105
8 X 8	CDMJX0808	12	516.00	110
10X 4	CDMJX1004	4	652.00	120
10X 6	CDMJX1006	12	632.00	125

Size (in.)	Item No.	Crt. Qty.	List Price (\$)	Wt. (lb.)
10X 8	CDMJX1008	8	783.00	130
10X10	CDMJX1010	8	826.00	145
12X 4	CDMJX1204	8	809.00	123
12X 6	CDMJX1206	8	798.00	140
12X 8	CDMJX1208	8	916.00	155
12X10	CDMJX1210	4	1,447.00	187
12X12	CDMJX1212	8	1,447.00	215
14X 6	CDMJX1406	8	1,440.00	210
14X 8	CDMJX1408	8	1,629.00	230
14X10	CDMJX1410		POA	255

* AWWA C110

Contd.....

CALL FOR BARE/BARE FITTINGS

CROSSES : MJ X MJ

Contd.....

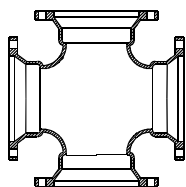

Size (in.)	Item No.	Crt. Qty.	List Price (\$)	Wt. (lb.)
14X12	CDMJX1412		2,928.00	270
14X14	CDMJX1414	4	2,536.00	336
16X 6	CDMJX1606	4	1,731.00	250
16X 8	CDMJX1608		2,002.00	264
16X10	CDMJX1610		2,613.00	285
16X12	CDMJX1612		2,749.00	310
16X14	CDMJX1614		POA	398
16X16	CDMJX1616		3,999.00	390
18X 6	CDMJX1806		5,062.00	392
18X10	CDMJX1810		6,080.00	
18X12	CDMJX1812		5,011.00	437
18X18	CDMJX1818		5,130.00	657
20X 6	CDMJX2006		4,510.00	298
20X 8	CDMJX2008		3,437.00	440
20X10	CDMJX2010		4,223.00	
20X12	CDMJX2012		3,229.00	558
20X16	CDMJX2016		5,308.00	632
20X18	CDMJX2018		5,451.00	698
20X20	CDMJX2020		7,408.00	798
24X 6	CDMJX2406		3,758.00	481
24X 8	CDMJX2408		3,905.00	500

Size (in.)	Item No.	Crt. Qty.	List Price (\$)	Wt. (lb.)
24X10	CDMJX2410		7,579.00	
24X12	CDMJX2412		4,843.00	620
24X16	CDMJX2416		5,621.00	720
24X18	CDMJX2418		6,777.00	868
24X20	CDMJX2420		7,915.00	1014
24X24	CDMJX2424		7,012.00	1038
30X 6	CDMJX3006		10,750.00	
30X 8	CDMJX3008		10,423.00	
30X12	CDMJX3012		9,462.00	1130
30X16	CDMJX3016		16,057.00	880
30X24	CDMJX3024		16,057.00	1640
30X30	CDMJX3030		15,385.00	1840
36X24	CDMJX3624		21,093.00	1955
36X36	CDMJX3636		22,200.00	2655
42X12	CDMJX4212		18,911.00	
42X16	CDMJX4216		20,105.00	
42X24	CDMJX4224		21,996.00	2668
42X30	CDMJX4230		38,440.00	2950
42X36	CDMJX4236		44,027.00	3375
42X42	CDMJX4242		49,825.00	3725
48X12	CDMJX4812		28,117.00	
48X16	CDMJX4816		29,854.00	
48X24	CDMJX4824		44,943.00	3682
48X30	CDMJX4830		46,594.00	4506
48X36	CDMJX4836		46,525.00	4700
48X42	CDMJX4842		46,525.00	4751
48X48	CDMJX4848		44,185.00	4955

REDUCERS : MJ X MJ

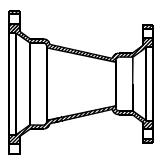

Size (in.)	Item No.	Crt. Qty.	List Price (\$)	Wt. (lb.)
3 X 2	CDMJR0302		POA	26
4 X 2	CDMJR0402	36	POA	35
4 X 3	CDMJR0403	80	120.00	18
6 X 2	CDMJR0602		216.00	
6 X 3	CDMJR0603	32	157.00	26
6 X 4	CDMJR0604	64	132.00	24
8 X 3	CDMJR0803	48	234.00	30
8 X 4	CDMJR0804	36	180.00	32
8 X 6	CDMJR0806	36	192.00	36
10X 4	CDMJR1004	9	291.00	46

Size (in.)	Item No.	Crt. Qty.	List Price (\$)	Wt. (lb.)
10X 6	CDMJR1006	27	246.00	47
10X 8	CDMJR1008	24	271.00	50
12X 4	CDMJR1204	18	369.00	58
12X 6	CDMJR1206	18	324.00	60
12X 8	CDMJR1208	18	330.00	60
12X10	CDMJR1210	18	367.00	64
14X 6	CDMJR1406	4	766.00	110
14X 8	CDMJR1408	12	766.00	115
14X10	CDMJR1410	12	577.00	120
14X12	CDMJR1412	4	577.00	130
16X 6	CDMJR1606	4	838.00	140
16X 8	CDMJR1608	4	805.00	155
16X10	CDMJR1610	4	776.00	160
16X12	CDMJR1612	6	748.00	161
16X14	CDMJR1614	4	950.00	165

CALL FOR BARE/BARE FITTINGS

* AWWA C110

Contd.....

REDUCERS : MJ X MJ

Contd.....

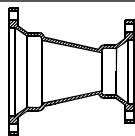

Size (in.)	Item No.	Crt. Qty.	List Price (\$)	Wt. (lb.)
18X 4	CDMJR1804	4	1,909.00	170
18X 8	CDMJR1808		1,252.00	200
18X10	CDMJR1810		1,182.00	195
18X12	CDMJR1812		1,152.00	180
18X14	CDMJR1814		1,565.00	200
18X16	CDMJR1816	2	1,221.00	195
20X 6	CDMJR2006		2,877.00	232
20X 8	CDMJR2008		1,457.00	227
20X10	CDMJR2010		1,660.00	220
20X12	CDMJR2012		1,281.00	205
20X14	CDMJR2014		1,274.00	200
20X16	CDMJR2016		1,182.00	215
20X18	CDMJR2018	2	1,593.00	225
24X 8	CDMJR2408		3,413.00	260
24X10	CDMJR2410		3,983.00	304
24X12	CDMJR2412		1,958.00	305
24X14	CDMJR2414		4,380.00	310
24X16	CDMJR2416		2,033.00	320
24X18	CDMJR2418		1,944.00	305
24X20	CDMJR2420		2,409.00	320
30X12	CDMJR3012		7,135.00	705
30X16	CDMJR3016		4,413.00	633
30X18	CDMJR3018		4,576.00	658
30X20	CDMJR3020		4,330.00	628
30X24	CDMJR3024		3,309.00	478
36X12	CDMJR3612		9,117.00	1037
36X16	CDMJR3616		5,459.00	1078
36X18	CDMJR3618		11,117.00	1329
36X20	CDMJR3620		6,708.00	975
36X24	CDMJR3624		5,326.00	770
36X30	CDMJR3630		5,792.00	650
42X16	CDMJR4216		POV	
42X18	CDMJR4218		POV	
42X20	CDMJR4220		8,762.00	1205
42X24	CDMJR4224		9,980.00	1356
42X30	CDMJR4230		7,857.00	1083
42X36	CDMJR4236		8,211.00	1114
48X16	CDMJR4816		POV	
48X18	CDMJR4818		POA	
48X20	CDMJR4820		11,034.00	1520
48X24	CDMJR4824		11,308.00	1700
48X30	CDMJR4830		13,628.00	1779

Size (in.)	Item No.	Crt. Qty.	List Price (\$)	Wt. (lb.)
48X36	CDMJR4836		12,008.00	1641
48X42	CDMJR4842		13,256.00	1462

REDUCERS : MJ X FE

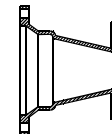

Size (in.)	Item No.	Crt. Qty.	List Price (\$)	Wt. (lb.)
4 X 3	CDMJFR0403		POA	17
6 X 4	CDMJFR0604	32	POA	23
8 X 6	CDMJFR0806	18	POA	34
12X 8	CDMJFR1208		POA	58
18X 8	CDMJFR1808		POA	190
18X12	CDMJFR1812		POA	198
24X12	CDMJFR2412		POA	318

REDUCERS : PE X PE

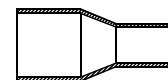

Size (in.)	Item No.	Crt. Qty.	List Price (\$)	Wt. (lb.)
4 X 3	CDMJRP0403	48	105.00	16
6 X 3	CDMJRP0603	48	165.00	22
6 X 4	CDMJRP0604	25	160.00	30
8 X 4	CDMJRP0804	36	237.00	34
8 X 6	CDMJRP0806	16	250.00	40
10X 4	CDMJRP1004		526.00	
10X 6	CDMJRP1006	9	327.00	46
10X 8	CDMJRP1008	9	338.00	49
12X 4	CDMJRP1204		413.00	58
12X 6	CDMJRP1206	9	413.00	59
12X 8	CDMJRP1208	9	425.00	59
12X10	CDMJRP1210	9	385.00	62
14X12	CDMJRP1412		632.00	95
16X 6	CDMJRP1606		709.00	128
16X 8	CDMJRP1608		919.00	130
16X10	CDMJRP1610		904.00	129
16X12	CDMJRP1612		754.00	115
16X14	CDMJRP1614		1,197.00	133
18X10	CDMJRP1810		2,782.00	165
18X12	CDMJRP1812		1,044.00	157
20X12	CDMJRP2012		2,586.00	198
20X16	CDMJRP2016		2,631.00	176
24X 8	CDMJRP2408		2,361.00	181
24X20	CDMJRP2420		2,579.00	256
30X16	CDMJRP3016		10,727.00	690

* AWWA C110

CALL FOR BARE/BARE FITTINGS

**REDUCERS :
MJ LARGE END (LEB)**

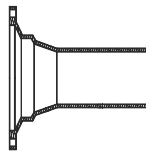

Size (in.)	Item No.	Crt. Qty.	List Price (\$)	Wt. (lb.)
4 X 3	CDMJRL0403	40	126.00	18
6 X 3	CDMJRL0603	30	180.00	30
6 X 4	CDMJRL0604	60	207.00	26
8 X 4	CDMJRL0804	50	234.00	35
8 X 6	CDMJRL0806	48	189.00	33
10X 4	CDMJRL1004	4	306.00	44
10X 6	CDMJRL1006	18	318.00	48
10X 8	CDMJRL1008	16	345.00	50
12X 4	CDMJRL1204	4	523.00	60
12X 6	CDMJRL1206	18	421.00	60
12X 8	CDMJRL1208	18	434.00	62
12X10	CDMJRL1210	18	448.00	64
14X 6	CDMJRL1406		766.00	112
14X 8	CDMJRL1408		766.00	108
14X10	CDMJRL1410		577.00	92
14X12	CDMJRL1412		699.00	96
16X 6	CDMJRL1606	4	1,033.00	148
16X 8	CDMJRL1608		1,096.00	140
16X10	CDMJRL1610	4	951.00	123
16X12	CDMJRL1612	4	753.00	119

Size (in.)	Item No.	Crt. Qty.	List Price (\$)	Wt. (lb.)
16X14	CDMJRL1614		1,003.00	135
18X 8	CDMJRL1808		1,252.00	195
18X10	CDMJRL1810		POA	185
18X12	CDMJRL1812		1,371.00	175
18X14	CDMJRL1814		1,565.00	200
18X16	CDMJRL1816		1,504.00	192
20X10	CDMJRL2010		1,644.00	210
20X12	CDMJRL2012		2,267.00	210
20X14	CDMJRL2014		1,274.00	205
20X16	CDMJRL2016		1,182.00	238
20X18	CDMJRL2018		POA	251
24X12	CDMJRL2412		2,267.00	300
24X14	CDMJRL2414		4,380.00	330
24X16	CDMJRL2416		2,302.00	340
24X18	CDMJRL2418		1,944.00	398
24X20	CDMJRL2420		4,674.00	280
30X18	CDMJRL3018		4,576.00	
30X24	CDMJRL3024		6,033.00	530
36X24	CDMJRL3624		8,386.00	817
36X30	CDMJRL3630		5,792.00	
42X30	CDMJRL4230		7,857.00	1023
42X36	CDMJRL4236		POA	1114
48X30	CDMJRL4830		16,920.00	1762
48X36	CDMJRL4836		18,130.00	1625

**REDUCERS :
MJ SMALL END (SEB)**

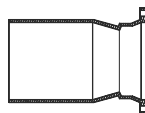

Size (in.)	Item No.	Crt. Qty.	List Price (\$)	Wt. (lb.)
3 X 2	CDMJRS0302		POA	25
4 X 2	CDMJRS0402		269.00	29
4 X 3	CDMJRS0403	32	109.00	18
6 X 3	CDMJRS0603	16	188.00	24
6 X 4	CDMJRS0604	48	137.00	26
8 X 4	CDMJRS0804	36	228.00	33
8 X 6	CDMJRS0806	24	207.00	35
10X 4	CDMJRS1004	4	304.00	44
10X 6	CDMJRS1006	27	318.00	46
10X 8	CDMJRS1008	12	340.00	49
12X 4	CDMJRS1204	4	434.00	60

Size (in.)	Item No.	Crt. Qty.	List Price (\$)	Wt. (lb.)
12X 6	CDMJRS1206	27	453.00	58
12X 8	CDMJRS1208	4	356.00	62
12X10	CDMJRS1210	6	429.00	61
14X 6	CDMJRS1406		997.00	100
14X 8	CDMJRS1408		1,266.00	99
14X10	CDMJRS1410	4	POA	97
14X12	CDMJRS1412	4	1,260.00	90
16X 6	CDMJRS1606	4	951.00	125
16X 8	CDMJRS1608	4	930.00	126
16X10	CDMJRS1610	4	941.00	124
16X12	CDMJRS1612	4	860.00	122
16X14	CDMJRS1614	4	POA	133
18X 8	CDMJRS1808		1,764.00	170
18X10	CDMJRS1810		POA	165
18X12	CDMJRS1812		1,174.00	155

CALL FOR BARE/BARE FITTINGS

* AWWA C110

Contd.....

**REDUCERS :
MJ SMALL END (SEB)**

Contd.....

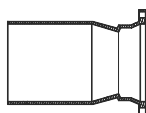

Size (in.)	Item No.	Crt. Qty.	List Price (\$)	Wt. (lb.)
18X14	CDMJRS1814		POA	175
18X16	CDMJRS1816		2,022.00	170
20X 8	CDMJRS2008		2,737.00	
20X10	CDMJRS2010		1,775.00	200
20X12	CDMJRS2012		1,331.00	170
20X14	CDMJRS2014		1,529.00	190
20X16	CDMJRS2016		1,449.00	185
20X18	CDMJRS2018		POA	210
24X 8	CDMJRS2408		3,160.00	
24X12	CDMJRS2412		2,151.00	275
24X14	CDMJRS2414		POA	310
24X16	CDMJRS2416		2,230.00	285
24X18	CDMJRS2418		2,518.00	300
24X20	CDMJRS2420		2,409.00	270
30X16	CDMJRS3016		4,797.00	565
30X18	CDMJRS3018		POA	648
30X20	CDMJRS3020		4,938.00	560
30X24	CDMJRS3024		5,926.00	536
36X16	CDMJRS3616		8,305.00	620
36X20	CDMJRS3620		7,193.00	874
36X24	CDMJRS3624		6,240.00	790
36X30	CDMJRS3630		6,992.00	788
42X24	CDMJRS4224		10,738.00	1204
42X30	CDMJRS4230		8,305.00	931
42X36	CDMJRS4236		9,125.00	1023
48X30	CDMJRS4830		17,233.00	1598
48X42	CDMJRS4842		18,349.00	

MJ PE CUTTING SLEEVES

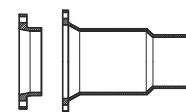

Size (in.)	Item No.	Crt. Qty.	List Price (\$)	Wt. (lb.)
4	CDMJPEESC04	36	POA	50
6	CDMJPEESC06	18	POA	62
8	CDMJPEESC08	18	POA	90
10	CDMJPEESC10	8	POA	105
12	CDMJPEESC12	8	POA	128
16	CDMJPEESC16		POA	275

MJ LONG SLEEVES

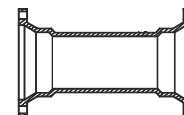

Size (in.)	Item No.	Crt. Qty.	List Price (\$)	Wt. (lb.)
2	CDMJLS02	50	143.00	7
3	CDMJLS03	126	108.00	17
4	CDMJLS04	75	123.00	20
6	CDMJLS06	36	206.00	29
8	CDMJLS08	27	330.00	45
10	CDMJLS10	18	395.00	61
12	CDMJLS12	12	532.00	76
14	CDMJLS14	8	803.00	128
16	CDMJLS16	8	1,016.00	159
18	CDMJLS18	5	1,339.00	200
20	CDMJLS20	5	1,617.00	236
24	CDMJLS24	5	2,128.00	306
30	CDMJLS30		4,456.00	634
36	CDMJLS36		6,254.00	889
42	CDMJLS42		8,363.00	1150
48	CDMJLS48		11,746.00	1435

REDUCERS : MJ X MJ ECCENTRIC

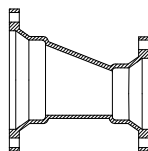

Size (in.)	Item No.	Crt. Qty.	List Price (\$)	Wt. (lb.)
20X18	CDMJER2018	48	POA	235
36X30	CDMJER3630	48	POA	650
42X36	CDMJER4236	25	POA	1114
48X30	CDMJER4830	36	POA	1779

CALL FOR BARE/BARE FITTINGS

* AWWA C110

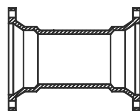
MJ SHORT SLEEVES

Size (in.)	Item No.	Crt. Qty.	List Price (\$)	Wt. (lb.)
2	CDMJSS02		POA	12
3	CDMJSS03	50	93.00	13
4	CDMJSS04	125	87.00	17
6	CDMJSS06	60	154.00	28
8	CDMJSS08	45	200.00	38
10	CDMJSS10	30	359.00	49
12	CDMJSS12	20	403.00	56
14	CDMJSS14	16	756.00	111
16	CDMJSS16	16	939.00	130
18	CDMJSS18	2	1,226.00	160
20	CDMJSS20	8	1,499.00	195
24	CDMJSS24	2	1,983.00	255
30	CDMJSS30		4,077.00	500
36	CDMJSS36		5,533.00	725
42	CDMJSS42		7,870.00	877
48	CDMJSS48		9,835.00	1136

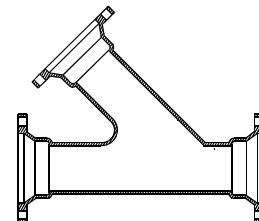
MJ 45° LATERAL (WYES)

Size (in.)	Item No.	Crt. Qty.	List Price (\$)	Wt. (lb.)
3 X 3	CDMJL0303		237.00	36
4 X 2	CDMJL0402		532.00	
4 X 3	CDMJL0403		261.00	40
4 X 4	CDMJL0404	30	296.00	42
6 X 4	CDMJL0604	12	304.00	53
6 X 6	CDMJL0606	16	443.00	85
8 X 4	CDMJL0804	6	610.00	75
8 X 6	CDMJL0806	6	513.00	92
8 X 8	CDMJL0808	6	645.00	105
10X 4	CDMJL1004	4	1,027.00	147
10X 6	CDMJL1006	4	1,079.00	156
10X 8	CDMJL1008	4	1,175.00	172
10X10	CDMJL1010	4	1,433.00	212
12X 4	CDMJL1204	2	1,465.00	185
12X 6	CDMJL1206	2	1,523.00	187
12X 8	CDMJL1208	2	1,635.00	190
12X10	CDMJL1210	2	1,920.00	245
12X12	CDMJL1212	2	1,706.00	275
14X 6	CDMJL1406	2	2,804.00	248
14X 8	CDMJL1408	2	5,811.00	281
14X10	CDMJL1410	2	2,900.00	320
14X14	CDMJL1414	2	3,095.00	474
16X 6	CDMJL1606	2	2,062.00	300
16X 8	CDMJL1608	2	2,418.00	349
16X10	CDMJL1610		4,651.00	372
16X12	CDMJL1612		3,101.00	453
16X16	CDMJL1616	2	3,773.00	575

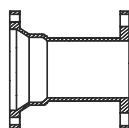
ADAPTERS : MJ X FLANGE

Size (in.)	Item No.	Crt. Qty.	List Price (\$)	Wt. (lb.)
3	CDMJFA03	150	116.00	14
4	CDMJFA04	120	132.00	23
6	CDMJFA06	45	182.00	30
8	CDMJFA08	45	273.00	46
10	CDMJFA10	30	473.00	62
12	CDMJFA12	24	605.00	98
14	CDMJFA14	20	960.00	143
16	CDMJFA16	10	1,096.00	170
18	CDMJFA18	2	1,729.00	220
20	CDMJFA20	10	2,059.00	240
24	CDMJFA24	2	2,532.00	322
30	CDMJFA30		4,661.00	544
36	CDMJFA36		6,676.00	798
42	CDMJFA42		18,299.00	1214
48	CDMJFA48		21,963.00	1600

CALL FOR BARE/BARE FITTINGS

* AWWA C110

MJ OFFSET

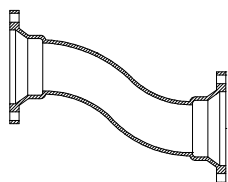

Size (in.)	Item No.	Crt. Qty.	List Price (\$)	Wt. (lb.)
3 X 6	CDMJO0306		162.00	30
3 X 12	CDMJO0312		235.00	40
3 X 18	CDMJO0318		273.00	49
3 X 24	CDMJO0324		325.00	55
4 X 6	CDMJO0406	12	220.00	25
4 X 12	CDMJO0412	12	284.00	55
4 X 18	CDMJO0418	8	383.00	65
4 X 24	CDMJO0424	16	440.00	75
6 X 6	CDMJO0606	12	374.00	29
6 X 12	CDMJO0612	16	487.00	69
6 X 18	CDMJO0618	8	595.00	87
6 X 24	CDMJO0624	8	753.00	107
8 X 6	CDMJO0806	4	538.00	80
8 X 12	CDMJO0812	4	692.00	104
8 X 18	CDMJO0818	4	863.00	135
8 X 24	CDMJO0824	3	1,226.00	141
10 X 6	CDMJO1006	4	769.00	110
10 X 12	CDMJO1012	4	1,010.00	135
10 X 18	CDMJO1018	4	1,204.00	165
10 X 24	CDMJO1024	4	2,355.00	175
12 X 6	CDMJO1206	4	1,087.00	118
12 X 12	CDMJO1212	4	1,207.00	203
12 X 18	CDMJO1218	4	1,460.00	230
12 X 24	CDMJO1224	2	2,061.00	277
12 X 30	CDMJO1230		1,960.00	285
16 X 12	CDMJO1612		6,622.00	305
16 X 18	CDMJO1618		7,830.00	362
20 X 12	CDMJO2012		9,767.00	437
20 X 18	CDMJO2018		12,984.00	581

MJ X PE OFFSET

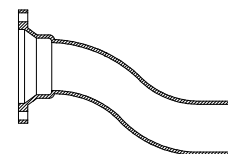

Size (in.)	Item No.	Crt. Qty.	List Price (\$)	Wt. (lb.)
3 X 6	CDMJOP0306		210.00	32
3 X 12	CDMJOP0312		278.00	42
3 X 18	CDMJOP0318		341.00	54
3 X 24	CDMJOP0324		380.00	58
4 X 6	CDMJOP0406	12	313.00	45
4 X 12	CDMJOP0412	12	385.00	56
4 X 18	CDMJOP0418	16	465.00	62
4 X 24	CDMJOP0424	6	510.00	70
6 X 6	CDMJOP0606	12	367.00	55
6 X 12	CDMJOP0612	8	480.00	68
6 X 18	CDMJOP0618	8	678.00	97
6 X 24	CDMJOP0624	4	827.00	116
8 X 6	CDMJOP0806	4	553.00	84
8 X 12	CDMJOP0812	4	776.00	110
8 X 18	CDMJOP0818	4	874.00	124
8 X 24	CDMJOP0824	3	923.00	147
10 X 6	CDMJOP1006	6	918.00	127
10 X 12	CDMJOP1012	4	1,212.00	130
10 X 18	CDMJOP1018	4	1,330.00	160
10 X 24	CDMJOP1024	4	1,672.00	169
12 X 6	CDMJOP1206	4	1,376.00	115
12 X 12	CDMJOP1212	4	1,395.00	198
12 X 18	CDMJOP1218	4	1,902.00	270
12 X 24	CDMJOP1224	2	2,351.00	335
12 X 30	CDMJOP1230		1,447.00	225

SWIVEL GLAND

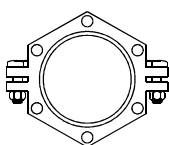

Size (in.)	Item No.	Crt. Qty.	List Price (\$)	Wt. (lb.)
4	CDMJGS04	100	86.00	8
6	CDMJGS06	100	95.00	9
8	CDMJGS08	100	114.00	11
12	CDMJGS12	50	294.00	24

* AWWA C110

**HYDRANT ADAPTERS :
SWIVEL X SWIVEL
WITH TWO-SWIVEL GLAND**

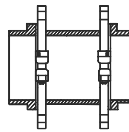

Size (in.)	Item No.	Crt. Qty.	List Price (\$)	Wt. (lb.)
6 X 12	CDMJHHA0612		POA	30
6 X 13	CDMJHHA0613		327.00	32
6 X 18	CDMJHHA0618		POA	49
6 X 24	CDMJHHA0624		441.00	52
8 X 13	CDMJHHA0813		473.00	65

**HYDRANT ADAPTERS :
SWIVEL X SOLID
WITH SWIVEL GLAND
(ANCHOR COUPLING)**

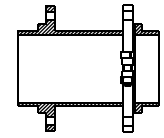

Size (in.)	Item No.	Crt. Qty.	List Price (\$)	Wt. (lb.)
4 X 13	CDMJHA0413	18	210.00	29
6 X 13	CDMJHA0613	36	369.00	46
6 X 18	CDMJHA0618	24	407.00	55
6 X 24	CDMJHA0624	24	549.00	59
6 X 36	CDMJHA0636	6	697.00	75
6 X 48	CDMJHA0648		915.00	94
8 X 13	CDMJHA0813	24	473.00	54
8 X 18	CDMJHA0818		POA	67
8 X 24	CDMJHA0824		POA	82
8 X 48	CDMJHA0848		POA	143
10 X 13	CDMJHA1013	12	840.00	89
12 X 13	CDMJHA1213	8	1,244.00	120

**HYDRANT ELL :
SWIVEL X SWIVEL
WITH TWO-SWIVEL GLAND**

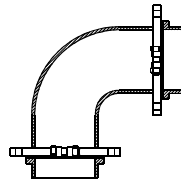

Size (in.)	Item No.	Crt. Qty.	List Price (\$)	Wt. (lb.)
6	CDMJHB9006	24	431.00	50

MJ CAPS : SOLID



Size (in.)	Item No.	Crt. Qty.	List Price (\$)	Wt. (lb.)
2	CDMJC02		POA	6
3	CDMJC03	300	51.00	8
4	CDMJC04	240	53.00	10
6	CDMJC06	144	93.00	17
8	CDMJC08	108	151.00	22
10	CDMJC10	72	189.00	32
12	CDMJC12	52	282.00	42
14	CDMJC14	36	424.00	70
16	CDMJC16	20	566.00	98
18	CDMJC18	20	714.00	120
20	CDMJC20	20	923.00	130
24	CDMJC24	10	1,268.00	170
30	CDMJC30	2	2,890.00	385
36	CDMJC36	2	5,257.00	614
42	CDMJC42		7,966.00	893
48	CDMJC48		9,601.00	1067

CALL FOR BARE/BARE FITTINGS

* AWWA C110

MJ CAPS : 2" TAPPED



Size (in.)	Item No.	Crt. Qty.	List Price (\$)	Wt. (lb.)
2	CDMJCT02		POA	10
3	CDMJCT03	300	106.00	8
4	CDMJCT04	240	108.00	10
6	CDMJCT06	144	148.00	17
8	CDMJCT08	108	206.00	22
10	CDMJCT10	72	244.00	32
12	CDMJCT12	52	338.00	42
14	CDMJCT14	36	510.00	70
16	CDMJCT16	20	652.00	98
18	CDMJCT18	20	827.00	120
20	CDMJCT20	20	1,035.00	130
24	CDMJCT24	10	1,378.00	202
30	CDMJCT30	2	3,056.00	385
36	CDMJCT36	2	5,420.00	614
42	CDMJCT42		8,189.00	893
48	CDMJCT48		9,823.00	1076

MJ PLUGS : SOLID



Size (in.)	Item No.	Crt. Qty.	List Price (\$)	Wt. (lb.)
2	CDMJPO2		POA	6
3	CDMJPO3	100	77.00	8
4	CDMJPO4	100	65.00	10
6	CDMJPO6	144	122.00	22
8	CDMJPO8	66	180.00	32
10	CDMJPO10	52	313.00	40
12	CDMJPO12	40	308.00	55
14	CDMJPO14	16	636.00	70
16	CDMJPO16	10	811.00	105
18	CDMJPO18	4	1,039.00	125
20	CDMJPO20	4	1,364.00	139
24	CDMJPO24	4	1,892.00	180
30	CDMJPO30	2	3,752.00	433
36	CDMJPO36	2	5,792.00	674
42	CDMJPO42		8,035.00	1067
48	CDMJPO48		10,710.00	1313

MJ PLUGS : 2" TAPPED



Size (in.)	Item No.	Crt. Qty.	List Price (\$)	Wt. (lb.)
2	CDMJPT02		POA	5
3	CDMJPT03	300	128.00	8
4	CDMJPT04	240	120.00	10
6	CDMJPT06	144	175.00	22
8	CDMJPT08	108	234.00	32
10	CDMJPT10	66	367.00	40
12	CDMJPT12	24	361.00	55
14	CDMJPT14	32	721.00	70
16	CDMJPT16	20	898.00	105
18	CDMJPT18	20	1,152.00	125
20	CDMJPT20	20	1,477.00	139
24	CDMJPT24	10	2,002.00	180
30	CDMJPT30	2	3,918.00	433
36	CDMJPT36	2	5,961.00	674
42	CDMJPT42		8,259.00	1067
48	CDMJPT48		10,932.00	1313

CALL FOR BARE/BARE FITTINGS

* AWWA C110

HYDRANT EXTENSIONS*

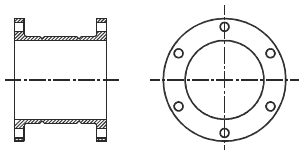

CALL for Net Pricing & Availability

HYDRANT BURIES*

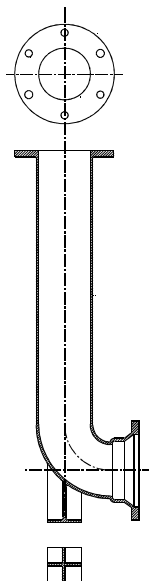

CALL for Net Pricing & Availability

CALL FOR BARE/BARE FITTINGS

* AWWA C110

Utility Pipe Fittings & Accessories

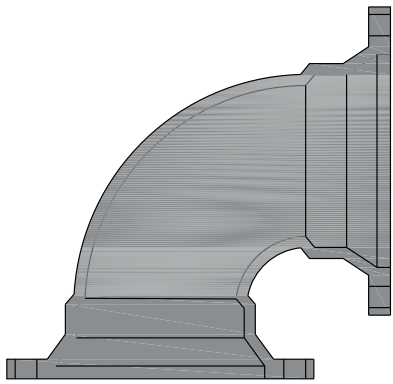

ANSI/AWWA C110/A21.10
FULL BODY MJ FITTINGS

PRICE LIST

Effective December 16, 2024



**BENDS : MJ X MJ
90° (1/4)**

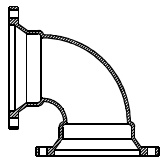

Size (in.)	Item No.	Crt. Qty.	List Price (\$)	Wt. (lb.)
2	XDMJB9002	36	271.00	14
3	XDMJB9003	36	245.00	35
4	XDMJB9004	24	308.00	55
6	XDMJB9006	12	473.00	85
8	XDMJB9008	12	756.00	125
10	XDMJB9010	4	1,341.00	190
12	XDMJB9012	4	1,467.00	255
14	XDMJB9014	0	2,767.00	380
16	XDMJB9016	0	3,320.00	430
18	XDMJB9018	0	4,939.00	545
20	XDMJB9020	0	5,584.00	680
24	XDMJB9024	0	7,206.00	1025
30	XDMJB9030	0	12,740.00	1690
36	XDMJB9036	0	17,374.00	2475
42	XDMJB9042	0	30,409.00	3410
48	XDMJB9048	0	40,972.00	4595

**BENDS :MJ X MJ
45° (1/8)**

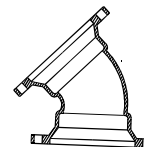

Size (in.)	Item No.	Crt. Qty.	List Price (\$)	Wt. (lb.)
2	XDMJB4502	36	180.00	13
3	XDMJB4503	0	210.00	30
4	XDMJB4504	36	282.00	50
6	XDMJB4506	12	421.00	75
8	XDMJB4508	12	614.00	110
10	XDMJB4510	4	975.00	155
12	XDMJB4512	4	1,234.00	215
14	XDMJB4514	0	2,046.00	270
16	XDMJB4516	0	2,562.00	340
18	XDMJB4518	0	3,380.00	420
20	XDMJB4520	0	3,587.00	530
24	XDMJB4524	0	5,013.00	755
30	XDMJB4530	0	10,027.00	1380
36	XDMJB4536	0	15,041.00	2095
42	XDMJB4542	0	26,351.00	2955
48	XDMJB4548	0	36,382.00	4080

**BENDS : MJ X MJ
22½° (1/16)**



Size (in.)	Item No.	Crt. Qty.	List Price (\$)	Wt. (lb.)
2	XDMJB2202	0	189.00	13
3	XDMJB2203	0	210.00	30
4	XDMJB2204	12	340.00	50
6	XDMJB2206	12	441.00	75
8	XDMJB2208	12	912.00	110
10	XDMJB2210	4	1,092.00	160
12	XDMJB2212	4	1,336.00	220
14	XDMJB2214	0	2,083.00	275
16	XDMJB2216	0	2,613.00	345
18	XDMJB2218	0	3,360.00	430
20	XDMJB2220	0	4,390.00	535
24	XDMJB2224	0	4,907.00	765
30	XDMJB2230	0	9,664.00	1400
36	XDMJB2236	0	14,659.00	2135
42	XDMJB2242	0	26,932.00	3020
48	XDMJB2248	0	37,185.00	4170

**BENDS : MJ X MJ
11¼° (1/32)**



Size (in.)	Item No.	Crt. Qty.	List Price (\$)	Wt. (lb.)
2	XDMJB1102	0	268.00	13
3	XDMJB1103	0	206.00	30
4	XDMJB1104	12	340.00	50
6	XDMJB1106	12	507.00	75
8	XDMJB1108	12	645.00	110
10	XDMJB1110	0	1,092.00	160
12	XDMJB1112	6	1,523.00	220
14	XDMJB1114	0	2,083.00	275
16	XDMJB1116	0	2,613.00	345
18	XDMJB1118	0	3,467.00	430
20	XDMJB1120	0	4,403.00	540
24	XDMJB1124	0	5,946.00	770
30	XDMJB1130	0	11,762.00	1410
36	XDMJB1136	0	18,065.00	2145
42	XDMJB1142	0	27,066.00	3035
48	XDMJB1148	0	37,365.00	4190

CALL FOR BARE/BARE FITTINGS

BENDS : MJ X PE
90° (1/4)

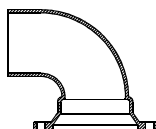

Size (in.)	Item No.	Crt. Qty.	List Price (\$)	Wt. (lb.)
3	XDMJBP9003	0	250.00	35
4	XDMJBP9004	8	357.00	50
6	XDMJBP9006	12	657.00	80
8	XDMJBP9008	12	1,030.00	120
10	XDMJBP9010	8	1,341.00	170
12	XDMJBP9012	4	1,795.00	255
14	XDMJBP9014	0	4,078.00	330
16	XDMJBP9016	0	3,101.00	410
18	XDMJBP9018	0	4,062.00	600
20	XDMJBP9020	0	5,074.00	775
24	XDMJBP9024	0	7,690.00	985
30	XDMJBP9030	0	13,256.00	1920
36	XDMJBP9036	0	19,315.00	2310
42	XDMJBP9042	0	34,905.00	3215
48	XDMJBP9048	0	61,866.00	4345

BENDS : MJ X PE
45° (1/8)

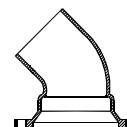

Size (in.)	Item No.	Crt. Qty.	List Price (\$)	Wt. (lb.)
3	XDMJBP4503	24	216.00	32
4	XDMJBP4504	50	325.00	45
6	XDMJBP4506	12	549.00	70
8	XDMJBP4508	24	828.00	105
10	XDMJBP4510	12	1,185.00	155
12	XDMJBP4512	4	1,514.00	215
14	XDMJBP4514	4	1,933.00	258
16	XDMJBP4516	4	2,213.00	320
18	XDMJBP4518	0	3,085.00	455
20	XDMJBP4520	0	3,905.00	664
24	XDMJBP4524	2	5,504.00	715
30	XDMJBP4530	0	10,664.00	1510
36	XDMJBP4536	0	16,138.00	1930
42	XDMJBP4542	0	31,914.00	2745
48	XDMJBP4548	0	46,271.00	3820

BENDS : MJ X PE
22½° (1/16)

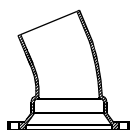

Size (in.)	Item No.	Crt. Qty.	List Price (\$)	Wt. (lb.)
3	XDMJBP2203	24	733.00	32
4	XDMJBP2204	24	323.00	50
6	XDMJBP2206	0	497.00	70
8	XDMJBP2208	0	744.00	105
10	XDMJBP2210	0	1,128.00	160
12	XDMJBP2212	0	1,547.00	220
14	XDMJBP2214	4	POA	335
16	XDMJBP2216	0	2,463.00	365
18	XDMJBP2218	0	3,167.00	455
20	XDMJBP2220	0	3,946.00	575
24	XDMJBP2224	0	5,662.00	930
30	XDMJBP2230	0	11,707.00	1540
36	XDMJBP2236	0	16,472.00	1970
42	XDMJBP2242	0	34,674.00	2815

BENDS : MJ X PE
11¼° (1/32)

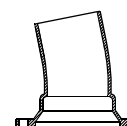

Size (in.)	Item No.	Crt. Qty.	List Price (\$)	Wt. (lb.)
3	XDMJBP1103	24	453.00	32
4	XDMJBP1104	24	705.00	50
6	XDMJBP1106	24	923.00	70
8	XDMJBP1108	16	744.00	105
12	XDMJBP1112	0	984.00	220
14	XDMJBP1114	0	5,085.00	260
16	XDMJBP1116	2	6,243.00	365
18	XDMJBP1118	0	POA	455
20	XDMJBP1120	0	7,430.00	575
24	XDMJBP1124	0	5,701.00	845
30	XDMJBP1130	0	10,914.00	1305
36	XDMJBP1136	0	16,555.00	2185
48	XDMJBP1148	0	46,785.00	3945

CALL FOR BARE/BARE FITTINGS

BENDS : MJ X FE
90° (1/4)

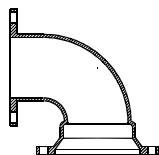

Size (in.)	Item No.	Crt. Qty.	List Price (\$)	Wt. (lb.)
4	XDMJFB9004	0	355.00	53
6	XDMJFB9006	0	491.00	75
8	XDMJFB9008	2	762.00	115
10	XDMJFB9010	0	1,087.00	177
12	XDMJFB9012	0	1,860.00	246
16	XDMJFB9016	0	3,181.00	465
18	XDMJFB9018	0	4,074.00	577
20	XDMJFB9020	0	4,815.00	745
24	XDMJFB9024	0	9,459.00	1150

BENDS : MJ X FE
45° (1/8)

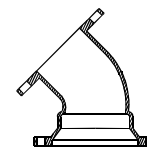

Size (in.)	Item No.	Crt. Qty.	List Price (\$)	Wt. (lb.)
4	XDMJFB4504	0	295.00	45
6	XDMJFB4506	0	458.00	69
8	XDMJFB4508	0	697.00	105
10	XDMJFB4510	0	1,087.00	155
12	XDMJFB4512	0	1,393.00	215
16	XDMJFB4516	0	2,463.00	360
18	XDMJFB4518	0	3,372.00	422
20	XDMJFB4520	0	4,815.00	543
24	XDMJFB4524	0	7,180.00	903
30	XDMJFB4530		12,752.00	1250

BENDS : MJ X FE
22½° (1/16)

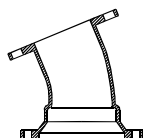

Size (in.)	Item No.	Crt. Qty.	List Price (\$)	Wt. (lb.)
4	XDMJFB2204	0	661.00	45
6	XDMJFB2206	0	394.00	69
8	XDMJFB2208	0	697.00	105
10	XDMJFB2210	0	1,006.00	155
12	XDMJFB2212	0	1,593.00	215
16	XDMJFB2216	0	2,155.00	373
18	XDMJFB2218	0	2,312.00	422
20	XDMJFB2220	0	7,484.00	575
24	XDMJFB2224	0	6,665.00	800

BENDS : MJ X FE
11¼° (1/32)

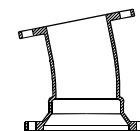

Size (in.)	Item No.	Crt. Qty.	List Price (\$)	Wt. (lb.)
4	XDMJFB1104	0	610.00	45
6	XDMJFB1106	0	467.00	69
8	XDMJFB1108	0	683.00	105
10	XDMJFB1110	0	1,673.00	155
12	XDMJFB1112	0	1,393.00	215
16	XDMJFB1116	0	2,508.00	360
18	XDMJFB1118	0	3,056.00	422
20	XDMJFB1120	0	7,484.00	575
24	XDMJFB1124	0	6,665.00	800

TEES : MJ X MJ

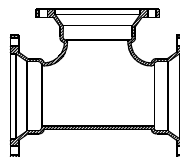

Size (in.)	Item No.	Crt. Qty.	List Price (\$)	Wt. (lb.)
2 X 2	XDMJT0202	36	216.00	22
3 X 2	XDMJT0302		323.00	43
3 X 3	XDMJT0303		434.00	55
4 X 2	XDMJT0402	24	974.00	65
4 X 3	XDMJT0403		532.00	75
4 X 4	XDMJT0404	12	540.00	80

Size (in.)	Item No.	Crt. Qty.	List Price (\$)	Wt. (lb.)
4 X 4 X 6	XDMJT040406		POA	115
6 X 2	XDMJT0602	12	758.00	100
6 X 3	XDMJT0603	24	742.00	110
6 X 4	XDMJT0604	12	774.00	115
6 X 6	XDMJT0606	12	733.00	125
6 X 6 X 8	XDMJT060608		POA	185

Contd.....

CALL FOR BARE/BARE FITTINGS

TEES : MJ X MJ
Contd.....

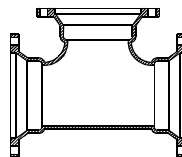

Size (in.)	Item No.	Crt. Qty.	List Price (\$)	Wt. (lb.)
8 X 3	XDMJT0803		1,504.00	155
8 X 4	XDMJT0804	9	1,113.00	165
8 X 6	XDMJT0806	9	1,006.00	175
8 X 8	XDMJT0808	9	1,087.00	185
10 X 3	XDMJT1003		POA	216
10 X 4	XDMJT1004	12	1,655.00	235
10 X 6	XDMJT1006	4	1,706.00	250
10 X 8	XDMJT1008	4	1,773.00	260
10 X 10	XDMJT1010	4	2,114.00	310
12 X 3	XDMJT1203		POA	290
12 X 4	XDMJT1204	8	2,179.00	315
12 X 6	XDMJT1206	4	1,969.00	325
12 X 8	XDMJT1208	4	2,353.00	340
12 X 10	XDMJT1210	4	2,699.00	390
12 X 12	XDMJT1212	4	2,838.00	410
14 X 4	XDMJT1404		4,206.00	383
14 X 6	XDMJT1406	4	3,292.00	435
14 X 8	XDMJT1408		3,404.00	450
14 X 10	XDMJT1410		3,518.00	465
14 X 12	XDMJT1412		3,745.00	495
14 X 14	XDMJT1414		3,933.00	520
16 X 4	XDMJT1604		5,217.00	600
16 X 6	XDMJT1606		4,086.00	540
16 X 8	XDMJT1608		4,161.00	550
16 X 10	XDMJT1610		4,312.00	570
16 X 12	XDMJT1612		4,462.00	590
16 X 14	XDMJT1614		4,689.00	620
16 X 16	XDMJT1616		5,120.00	650
18 X 4	XDMJT1804		POA	528
18 X 6	XDMJT1806		4,607.00	590
18 X 8	XDMJT1808		4,727.00	605
18 X 10	XDMJT1810		4,843.00	620
18 X 12	XDMJT1812		4,997.00	640
18 X 14	XDMJT1814		5,898.00	755
18 X 16	XDMJT1816		6,132.00	785
18 X 18	XDMJT1818		6,403.00	820
20 X 6	XDMJT2006	2	6,205.00	725
20 X 8	XDMJT2008	2	7,180.00	735
20 X 10	XDMJT2010		5,898.00	755
20 X 12	XDMJT2012	2	5,959.00	775

Size (in.)	Item No.	Crt. Qty.	List Price (\$)	Wt. (lb.)
20 X 14	XDMJT2014		6,207.00	795
20 X 16	XDMJT2016		7,275.00	945
20 X 18	XDMJT2018		7,690.00	985
20 X 20	XDMJT2020		6,475.00	1020
24 X 4	XDMJT2404		9,082.00	985
24 X 6	XDMJT2406		7,690.00	985
24 X 8	XDMJT2408		7,806.00	1000
24 X 10	XDMJT2410		9,566.00	1020
24 X 12	XDMJT2412		8,039.00	1030
24 X 14	XDMJT2414		8,238.00	1055
24 X 16	XDMJT2416		8,464.00	1075
24 X 18	XDMJT2418		10,926.00	1400
24 X 20	XDMJT2420		13,230.00	1450
24 X 24	XDMJT2424		13,964.00	1535
30 X 6	XDMJT3006		14,466.00	1730
30 X 8	XDMJT3008		14,593.00	1745
30 X 10	XDMJT3010		14,716.00	1760
30 X 12	XDMJT3012		14,883.00	1780
30 X 14	XDMJT3014		22,578.00	1800
30 X 16	XDMJT3016		21,616.00	1820
30 X 18	XDMJT3018		15,429.00	1845
30 X 20	XDMJT3020		15,678.00	1875
30 X 24	XDMJT3024		20,064.00	2400
30 X 30	XDMJT3030		21,695.00	2595
36 X 6	XDMJT3606		20,902.00	2439
36 X 8	XDMJT3608		21,068.00	2520
36 X 10	XDMJT3610		21,823.00	2535
36 X 12	XDMJT3612		21,322.00	2550
36 X 14	XDMJT3614		21,488.00	2570
36 X 16	XDMJT3616		17,677.00	2585
36 X 18	XDMJT3618		21,823.00	2610
36 X 20	XDMJT3620		22,032.00	2635
36 X 24	XDMJT3624		22,491.00	2690
36 X 30	XDMJT3630		29,640.00	3545
36 X 36	XDMJT3636		24,472.00	3745
42 X 6	XDMJT4206		56,639.00	3440
42 X 12	XDMJT4212		31,701.00	3555
42 X 14	XDMJT4214		31,879.00	3575
42 X 16	XDMJT4216		32,058.00	3595
42 X 18	XDMJT4218		59,747.00	3615

Contd.....

CALL FOR BARE/BARE FITTINGS

TEES : MJ X MJ

Contd.....

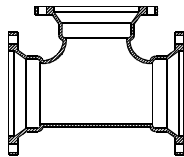

Size (in.)	Item No.	Crt. Qty.	List Price (\$)	Wt. (lb.)
42 X 20	XDMJT4220		59,747.00	3640
42 X 24	XDMJT4224		32,906.00	3690
42 X 30	XDMJT4230		41,465.00	4650
42 X 36	XDMJT4236		54,170.00	6075
42 X 42	XDMJT4242		56,355.00	6320
48 X 12	XDMJT4812		64,916.00	4870
48 X 14	XDMJT4814		64,765.00	4885
48 X 16	XDMJT4816		67,465.00	4905
48 X 18	XDMJT4818		69,817.00	4925
48 X 20	XDMJT4820		62,906.00	4950
48 X 24	XDMJT4824		44,540.00	4995
48 X 30	XDMJT4830		45,834.00	5140
48 X 36	XDMJT4836		56,000.00	6280
48 X 42	XDMJT4842		72,492.00	8130
48 X 36 X 48	XDMJT483648		POA	6397
48 X 48	XDMJT4848		75,078.00	8420

TEES : MJ X PE X MJ

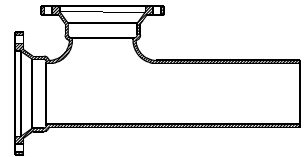

Size (in.)	Item No.	Crt. Qty.	List Price (\$)	Wt. (lb.)
4 X 4	XDMJPT0404		POA	75
6 X 6	XDMJPT0606		POA	120
8 X 4	XDMJPT0804	6	1,550.00	160
8 X 6	XDMJPT0806		POA	170
8 X 8	XDMJPT0808		1,241.00	180
10 X 10	XDMJPT1010		POA	250
12 X 4	XDMJPT1204		POA	315
12 X 6	XDMJPT1206		3,232.00	325
12 X 8	XDMJPT1208		2,936.00	340
12 X 10	XDMJPT1210		POA	390
12 X 12	XDMJPT1212		3,627.00	410
14 X 14	XDMJPT1414		4,501.00	500
16 X 8	XDMJPT1608	2	4,330.00	530
16 X 16	XDMJPT1616		5,605.00	625
24 X 6	XDMJPT2406	2	11,035.00	945
24 X 8	XDMJPT2408		11,303.00	960
24 X 12	XDMJPT2412		11,503.00	990
24 X 16	XDMJPT2416		11,946.00	1035
24 X 24	XDMJPT2424		17,500.00	1490
36 X 12	XDMJPT3612		31,250.00	2375
36 X 24	XDMJPT3624		36,238.00	2515
36 X 36	XDMJPT3636		51,147.00	3565

MJ X SWIVEL HYDRANT TEE (W/SWIVEL GLAND)

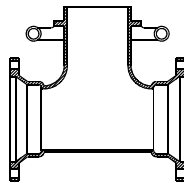

Size (in.)	Item No.	Crt. Qty.	List Price (\$)	Wt. (lb.)
6 X 6	XDMJTH0606	9	836.00	145
8 X 6	XDMJTH0806	9	1,100.00	165
8 X 8	XDMJTH0808		2,034.00	210
10 X 6	XDMJTH1006		1,902.00	270
12 X 6	XDMJTH1206	4	2,392.00	365
12 X 8	XDMJTH1208	4	4,644.00	350
16 X 6	XDMJTH1606		4,201.00	619
16 X 8	XDMJTH1608		POA	649
20 X 6	XDMJTH2006	2	15,729.00	725
24 X 6	XDMJTH2406		19,256.00	973
30 X 6	XDMJTH3006		17,077.00	2070
36 X 6	XDMJTH3606		21,068.00	2830

TEES : MJ TAPPED 2"

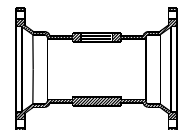

Size (in.)	Item No.	Crt. Qty.	List Price (\$)	Wt. (lb.)
4 X 4	XDMJX0404T	0	379.00	45
6 X 6	XDMJX0606T	0	551.00	70
8 X 8	XDMJX0808T	0	838.00	95
10 X 10	XDMJX1010T	0	972.00	130
12 X 12	XDMJX1212T	0	1,219.00	165
16 X 16	XDMJX1616T	0	2,116.00	274
18 X 18	XDMJX1818T	0	3,731.00	305
20 X 20	XDMJX2020T	0	4,224.00	352
24 X 24	XDMJX2424T	0	5,156.00	496

CALL FOR BARE/BARE FITTINGS

TEES : MJ X FE

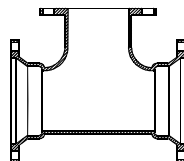

Size (in.)	Item No.	Crt. Qty.	List Price (\$)	Wt. (lb.)
3 X 3	XDMJFT0303		POA	45
4 X 2	XDMJFT0402		658.00	53
4 X 4	XDMJFT0404		631.00	74
6 X 3	XDMJFT0603		1,263.00	115
6 X 4	XDMJFT0604		913.00	109
6 X 6	XDMJFT0606	2	988.00	120
8 X 4	XDMJFT0804		1,279.00	159
8 X 6	XDMJFT0806	2	1,085.00	170
8 X 8	XDMJFT0808	2	1,343.00	194
10 X 4	XDMJFT1004		1,616.00	229
10 X 6	XDMJFT1006	12	1,562.00	245
10 X 8	XDMJFT1008		1,752.00	250
12 X 4	XDMJFT1204	2	2,249.00	323
12 X 6	XDMJFT1206	2	2,120.00	320
12 X 8	XDMJFT1208	2	3,248.00	342
12 X 10	XDMJFT1210		POA	372
12 X 12	XDMJFT1212		POA	401
14 X 6	XDMJFT1406		5,243.00	457
14 X 8	XDMJFT1408		8,043.00	473
16 X 4	XDMJFT1604		4,350.00	575
16 X 6	XDMJFT1606		4,577.00	605
16 X 8	XDMJFT1608		4,652.00	615
16 X 12	XDMJFT1612		4,926.00	651
16 X 16	XDMJFT1616		5,521.00	730
18 X 6	XDMJFT1806		5,192.00	665
18 X 8	XDMJFT1808		5,272.00	675
18 X 12	XDMJFT1812		5,506.00	735
18 X 18	XDMJFT1818		7,144.00	915
20 X 6	XDMJFT2006		6,809.00	820
20 X 8	XDMJFT2008		6,520.00	835
20 X 12	XDMJFT2012		7,512.00	700
20 X 20	XDMJFT2020		9,094.00	1165
24 X 6	XDMJFT2406		8,786.00	1125
24 X 8	XDMJFT2408		8,896.00	1140
24 X 12	XDMJFT2412		9,094.00	1165
24 X 18	XDMJFT2418		15,290.00	1349
24 X 24	XDMJFT2424		14,010.00	1795
30 X 6	XDMJFT3006		14,299.00	1800
30 X 8	XDMJFT3008		22,271.00	1725
30 X 30	XDMJFT3030		POA	3080

Size (in.)	Item No.	Crt. Qty.	List Price (\$)	Wt. (lb.)
36 X 6	XDMJFT3606		20,902.00	2430
36 X 8	XDMJFT3608		28,695.00	
36 X 12	XDMJFT3612		21,322.00	2550
36 X 16	XDMJFT3616		21,399.00	2450
36 X 24	XDMJFT3624		30,663.00	2660
36 X 30	XDMJFT3630		67,489.00	2964
36 X 36	XDMJFT3636		67,577.00	3461
42 X 12	XDMJFT4212		1,00,876.00	3547
42 X 16	XDMJFT4216		1,01,682.00	3562
42 X 24	XDMJFT4224		1,00,556.00	3527
48 X 24	XDMJFT4824		POA	4965

CROSSES : MJ X FE

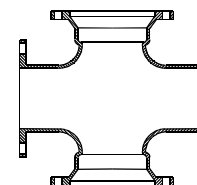

Size (in.)	Item No.	Crt. Qty.	List Price (\$)	Wt. (lb.)
6 X 6	XDMJFX0606	0	POA	140
8 X 6	XDMJFX0806	0	POA	185
8 X 8	XDMJFX0808	0	POA	240
10 X 10	XDMJFX1010	0	POA	354
12 X 6	XDMJFX1206	0	POA	340
12 X 8	XDMJFX1208	0	POA	365
12 X 12	XDMJFX1212	0	POA	487
16 X 8	XDMJFX1608	0	POA	655
16 X 16	XDMJFX1616	0	POA	875

CALL FOR BARE/BARE FITTINGS

CROSSES : MJ X MJ

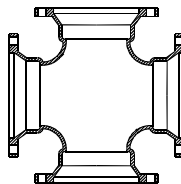

Size (in.)	Item No.	Crt. Qty.	List Price (\$)	Wt. (lb.)
4 X 4	XDMJX0404		744.00	105
6 X 4	XDMJX0604		988.00	142
6 X 6	XDMJX0606	8	1,075.00	160
8 X 4	XDMJX0804		1,306.00	185
8 X 6	XDMJX0806		1,447.00	205
8 X 8	XDMJX0808	4	1,578.00	235
10 X 6	XDMJX1006		2,005.00	285
10 X 8	XDMJX1008		2,179.00	310
10 X 10	XDMJX1010		2,671.00	380
12 X 4	XDMJX1204		2,993.00	340
12 X 6	XDMJX1206		2,532.00	360
12 X 8	XDMJX1208	2	2,665.00	385
12 X 12	XDMJX1212	2	3,423.00	495
14 X 8	XDMJX1408		3,404.00	500
14 X 14	XDMJX1414		4,804.00	635
16 X 6	XDMJX1606		4,350.00	575
16 X 8	XDMJX1608		4,577.00	605
16 X 12	XDMJX1612		9,025.00	685
16 X 16	XDMJX1616		5,974.00	790
18 X 8	XDMJX1808		4,954.00	655
18 X 10	XDMJX1810		5,349.00	685
18 X 12	XDMJX1812		5,662.00	725
18 X 18	XDMJX1818		7,768.00	995
20 X 8	XDMJX2008		6,076.00	790
20 X 12	XDMJX2012		6,716.00	860
20 X 16	XDMJX2016		8,472.00	1085
20 X 18	XDMJX2018		10,932.00	
20 X 20	XDMJX2020		9,602.00	1230
24 X 6	XDMJX2406		7,889.00	1025
24 X 8	XDMJX2408		8,158.00	1045
24 X 12	XDMJX2412		8,657.00	1110
24 X 16	XDMJX2416		9,369.00	1200
24 X 20	XDMJX2420		13,073.00	1675
24 X 24	XDMJX2424		14,323.00	1835
30 X 6	XDMJX3006		14,802.00	1770
30 X 12	XDMJX3012		15,596.00	1865
30 X 16	XDMJX3016		29,211.00	1968
30 X 24	XDMJX3024		22,366.00	2675
30 X 30	XDMJX3030		25,710.00	3075
36 X 12	XDMJX3612		21,990.00	2645

Size (in.)	Item No.	Crt. Qty.	List Price (\$)	Wt. (lb.)
36 X 16	XDMJX3616		37,844.00	2718
36 X 20	XDMJX3620		38,579.00	2815
36 X 24	XDMJX3624		34,862.00	2910
36 X 30	XDMJX3630		47,486.00	3978
36 X 36	XDMJX3636		36,534.00	4370
42 X 24	XDMJX4224		92,318.00	3924
42 X 30	XDMJX4230		1,16,566.00	5039
42 X 36	XDMJX4236		1,42,851.00	5428
42 X 42	XDMJX4242		1,52,342.00	7145
48 X 24	XDMJX4824		59,591.00	5225
48 X 30	XDMJX4830		62,722.00	5510
48 X 36	XDMJX4836		60,547.00	6795
48 X 42	XDMJX4842		88,010.00	8827
48 X 48	XDMJX4848		1,13,289.00	9400

MJ 45° LATERAL (WYES)

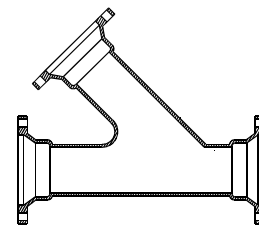

Size (in.)	Item No.	Crt. Qty.	List Price (\$)	Wt. (lb.)
3 X 3	XDMJL0303		425.00	60
4 X 3	XDMJL0403		729.00	
4 X 4	XDMJL0404		637.00	90
6 X 4	XDMJL0604	12	953.00	130
6 X 6	XDMJL0606	4	1,176.00	145
8 X 4	XDMJL0804		1,341.00	190
8 X 6	XDMJL0806	4	1,447.00	205
8 X 8	XDMJL0808	4	1,470.00	230
10 X 4	XDMJL1004		3,387.00	274
10 X 6	XDMJL1006		2,005.00	285
10 X 8	XDMJL1008		2,148.00	310
10 X 10	XDMJL1010		2,637.00	340
12 X 4	XDMJL1204		2,988.00	382
12 X 6	XDMJL1206		3,489.00	396
12 X 8	XDMJL1208		2,986.00	425

Contd.....

CALL FOR BARE/BARE FITTINGS

MJ 45° LATERAL (WYES) Contd.....

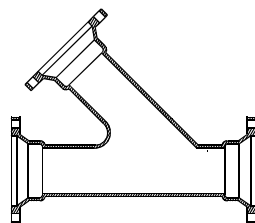

Size (in.)	Item No.	Crt. Qty.	List Price (\$)	Wt. (lb.)
12 X 10	XDMJL1210		4,474.00	512
12 X 12	XDMJL1212		3,758.00	535
14 X 6	XDMJL1406		4,276.00	615
14 X 8	XDMJL1408		4,843.00	630
14 X 12	XDMJL1412		7,097.00	652
14 X 14	XDMJL1414		5,713.00	725
16 X 6	XDMJL1606		5,825.00	770
16 X 8	XDMJL1608		6,011.00	795
16 X 10	XDMJL1610		6,276.00	835
16 X 12	XDMJL1612		6,579.00	872
16 X 16	XDMJL1616		6,730.00	1079
18 X 6	XDMJL1806		5,701.00	752
18 X 8	XDMJL1808		7,337.00	968
18 X 10	XDMJL1810		8,354.00	975
18 X 12	XDMJL1812		8,821.00	1015
18 X 16	XDMJL1816		8,974.00	1135
18 X 18	XDMJL1818		9,366.00	1200
20 X 6	XDMJL2006		12,707.00	872
20 X 8	XDMJL2008		13,908.00	689
20 X 10	XDMJL2010		9,487.00	1220
20 X 12	XDMJL2012		9,290.00	1260
20 X 14	XDMJL2014		16,638.00	1368
20 X 16	XDMJL2016		9,118.00	1375
20 X 20	XDMJL2020		11,904.00	1525
24 X 6	XDMJL2406		18,349.00	1874
24 X 8	XDMJL2408		20,948.00	1882
24 X 12	XDMJL2412		25,828.00	1388
24 X 16	XDMJL2416		27,452.00	1827
24 X 18	XDMJL2418		29,004.00	2075
24 X 20	XDMJL2420		23,883.00	2148
24 X 24	XDMJL2424		17,520.00	2372
30 X 12	XDMJL3012		39,095.00	3125
30 X 16	XDMJL3016		32,812.00	3264
30 X 18	XDMJL3018		33,874.00	2995
30 X 20	XDMJL3020		29,526.00	3418
30 X 24	XDMJL3024		31,546.00	3292
30 X 30	XDMJL3030		30,684.00	3670
36 X 12	XDMJL3612		54,209.00	4695
36 X 16	XDMJL3616		48,080.00	5050

Size (in.)	Item No.	Crt. Qty.	List Price (\$)	Wt. (lb.)
36 X 18	XDMJL3618		51,522.00	5025
36 X 20	XDMJL3620		44,248.00	5090
36 X 24	XDMJL3624		43,849.00	5851
36 X 30	XDMJL3630		48,483.00	5815
36 X 36	XDMJL3636		58,309.00	6900
42 X 24	XDMJL4224		60,723.00	6810
42 X 30	XDMJL4230		64,290.00	7280
42 X 36	XDMJL4236		74,498.00	8355
42 X 42	XDMJL4242		95,298.00	9915
48 X 20	XDMJL4820		93,167.00	6554
48 X 24	XDMJL4824		POA	
48 X 30	XDMJL4830		98,222.00	6574
48 X 48	XDMJL4848		99,640.00	11892

MJ X PE OFFSET

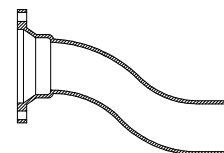

Size (in.)	Item No.	Crt. Qty.	List Price (\$)	Wt. (lb.)
4 X 6	XDMJOP0406		849.00	70
4 X 12	XDMJOP0412		872.00	80
4 X 24	XDMJOP0424		1,145.00	125
6 X 6	XDMJOP0606		1,041.00	105
6 X 12	XDMJOP0612		918.00	130
6 X 18	XDMJOP0618		1,064.00	160
6 X 24	XDMJOP0624		1,053.00	160
8 X 6	XDMJOP0806		1,940.00	155
8 X 12	XDMJOP0812		1,459.00	195
8 X 18	XDMJOP0818		2,923.00	240
8 X 24	XDMJOP0824		2,112.00	285
10 X 12	XDMJOP1012		POA	280
10 X 18	XDMJOP1018		POA	340
12 X 06	XDMJOP1206		3,185.00	328
12 X 12	XDMJOP1212		5,525.00	420
12 X 18	XDMJOP1218	2	6,467.00	520
12 X 24	XDMJOP1224		POA	630
16 X 18	XDMJOP1618		POA	690

CALL FOR BARE/BARE FITTINGS

MJ OFFSET

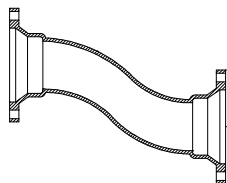

Size (in.)	Item No.	Crt. Qty.	List Price (\$)	Wt. (lb.)
4 X 6	XDMJO0406	0	POA	75
4 X 12	XDMJO0412	0	604.00	85
4 X 18	XDMJO0418	0	744.00	105
4 X 24	XDMJO0424	0	884.00	126
6 X 6	XDMJO0606	0	776.00	114
6 X 12	XDMJO0612	0	953.00	135
6 X 18	XDMJO0618	0	1,163.00	188
6 X 24	XDMJO0624	0	1,082.00	182
8 X 6	XDMJO0806	0	1,128.00	177
8 X 12	XDMJO0812	0	1,406.00	231
8 X 18	XDMJO0818	0	1,703.00	287
8 X 24	XDMJO0824	0	1,781.00	280
10 X 12	XDMJO1012	0	2,484.00	347
10 X 18	XDMJO1018	0	2,391.00	340
10 X 24	XDMJO1024	0	2,950.00	420
12 X 6	XDMJO1206	0	5,204.00	345
12 X 12	XDMJO1212	0	2,950.00	420
12 X 18	XDMJO1218	0	3,654.00	520
12 X 24	XDMJO1224	0	4,496.00	649
16 X 12	XDMJO1612	0	4,968.00	715
16 X 18	XDMJO1618	0	5,231.00	850
20 X 12	XDMJO2012	0	5,662.00	1025
20 X 18	XDMJO2018	0	9,290.00	1246
20 X 24	XDMJO2024	0	21,975.00	1362

MJ LONG SLEEVES

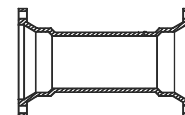

Size (in.)	Item No.	Crt. Qty.	List Price (\$)	Wt. (lb.)
2	XDMJSL02	0	240.00	18
3	XDMJSL03	0	216.00	30
4	XDMJSL04	24	269.00	45
6	XDMJSL06	27	385.00	65
8	XDMJSL08	27	473.00	85
10	XDMJSL10	12	811.00	115
12	XDMJSL12	12	913.00	145
14	XDMJSL14	2	1,477.00	195
16	XDMJSL16	2	1,663.00	235
18	XDMJSL18	0	2,378.00	285
20	XDMJSL20	2	2,414.00	325
24	XDMJSL24	0	3,185.00	425
30	XDMJSL30	0	7,471.00	1088
36	XDMJSL36	0	9,007.00	1052
42	XDMJSL42	0	10,181.00	1550
48	XDMJSL48	0	16,220.00	1940

MJ SHORT SLEEVES

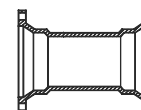

Size (in.)	Item No.	Crt. Qty.	List Price (\$)	Wt. (lb.)
2	XDMJSS02	48	137.00	12
3	XDMJSS03		299.00	25
4	XDMJSS04	4	240.00	35
6	XDMJSS06	4	269.00	45
8	XDMJSS08	27	385.00	65
10	XDMJSS10	4	583.00	85
12	XDMJSS12	12	766.00	110
14	XDMJSS14		1,510.00	150
16	XDMJSS16		1,299.00	180
18	XDMJSS18		1,684.00	215
20	XDMJSS20		1,879.00	240
24	XDMJSS24		2,898.00	320
30	XDMJSS30		6,310.00	635
36	XDMJSS36		8,612.00	855
42	XDMJSS42		9,947.00	1115
48	XDMJSS48		14,944.00	1385

MJ DUAL PURPOSE SLEEVES

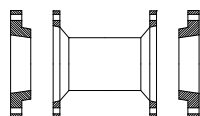

Size (in.)	Item No.	Crt. Qty.	List Price (\$)	Wt. (lb.)
4	XDMJSSDP04	24	631.00	35
6	XDMJSSDP06	18	448.00	45
8	XDMJSSDP08	0	590.00	65

CALL FOR BARE/BARE FITTINGS

REDUCERS : MJ X MJ

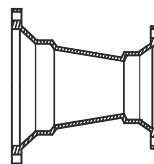

Size (in.)	Item No.	Crt. Qty.	List Price (\$)	Wt. (lb.)
3 X 2	XDMJR0302	60	223.00	26
4 X 2	XDMJR0402	48	223.00	30
4 X 3	XDMJR0403	48	272.00	40
6 X 2	XDMJR0602	24	327.00	45
6 X 3	XDMJR0603	24	374.00	55
6 X 4	XDMJR0604	24	356.00	60
8 X 3	XDMJR0803		672.00	84
8 X 4	XDMJR0804	16	582.00	80
8 X 6	XDMJR0806	16	559.00	95
10 X 4	XDMJR1004		1,046.00	105
10 X 6	XDMJR1006	12	787.00	115
10 X 8	XDMJR1008	12	926.00	135
12 X 4	XDMJR1204	8	1,002.00	135
12 X 6	XDMJR1206	8	1,248.00	150
12 X 8	XDMJR1208	8	1,145.00	165
12 X 10	XDMJR1210	8	1,316.00	190
14 X 6	XDMJR1406	4	1,286.00	190
14 X 8	XDMJR1408		1,593.00	214
14 X 10	XDMJR1410		1,800.00	236
14 X 12	XDMJR1412	2	1,935.00	255
16 X 6	XDMJR1606		1,742.00	230
16 X 8	XDMJR1608		2,283.00	250
16 X 10	XDMJR1610		2,078.00	280
16 X 12	XDMJR1612		2,493.00	305
16 X 14	XDMJR1614		2,536.00	335
18 X 8	XDMJR1808		2,307.00	295
18 X 10	XDMJR1810		2,543.00	325
18 X 12	XDMJR1812		2,737.00	350
18 X 14	XDMJR1814		2,971.00	380
18 X 16	XDMJR1816		3,244.00	415
20 X 8	XDMJR2008		5,674.00	345
20 X 10	XDMJR2010		2,890.00	375
20 X 12	XDMJR2012		3,167.00	405
20 X 14	XDMJR2014		4,820.00	435
20 X 16	XDMJR2016		3,672.00	470
20 X 18	XDMJR2018		3,985.00	510
24 X 12	XDMJR2412		4,296.00	550
24 X 16	XDMJR2416		4,804.00	615
24 X 18	XDMJR2418		5,154.00	660

Size (in.)	Item No.	Crt. Qty.	List Price (\$)	Wt. (lb.)
24 X 20	XDMJR2420		5,506.00	705
30 X 12	XDMJR3012		8,604.00	920
30 X 16	XDMJR3016		8,239.00	985
30 X 18	XDMJR3018		8,280.00	990
30 X 20	XDMJR3020		8,786.00	1050
30 X 24	XDMJR3024		9,745.00	1165
36 X 20	XDMJR3620		12,126.00	1450
36 X 24	XDMJR3624		13,209.00	1580
36 X 30	XDMJR3630		15,511.00	1855
42 X 20	XDMJR4220		17,080.00	1928
42 X 24	XDMJR4224		18,371.00	2060
42 X 30	XDMJR4230		21,135.00	2370
42 X 36	XDMJR4236		24,035.00	2714
48 X 30	XDMJR4830		26,797.00	3005
48 X 36	XDMJR4836		30,053.00	3385
48 X 42	XDMJR4842		33,438.00	3776

REDUCERS : FE X MJ

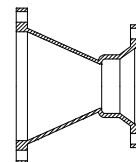

Size (in.)	Item No.	Crt. Qty.	List Price (\$)	Wt. (lb.)
4 X 3	FXDMJR0403	0	237.00	34
6 X 4	FXDMJR0604	0	345.00	60
8 X 4	FXDMJR0804	0	473.00	80
8 X 6	FXDMJR0806	0	569.00	89
10 X 6	FXDMJR1006	0	769.00	114
10 X 8	FXDMJR1008	0	843.00	130
12 X 6	FXDMJR1206	0	938.00	151
12 X 8	FXDMJR1208	0	1,098.00	183
12 X 10	FXDMJR1210	0	1,214.00	190
16 X 12	FXDMJR1612	0	2,082.00	305

CALL FOR BARE/BARE FITTINGS

**REDUCERS : MJ
SMALL END (SEB)**

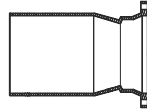

Size (in.)	Item No.	Crt. Qty.	List Price (\$)	Wt. (lb.)
3 X 2	XDMJRS0302	48	339.00	14
4 X 2	XDMJRS0402	48	278.00	18
4 X 3	XDMJRS0403		250.00	35
6 X 2	XDMJRS0602	26	346.00	45
6 X 3	XDMJRS0603		357.00	50
6 X 4	XDMJRS0604		425.00	60
8 X 3	XDMJRS0803		540.00	77
8 X 4	XDMJRS0804	16	566.00	80
8 X 6	XDMJRS0806	16	637.00	90
10 X 6	XDMJRS1006		811.00	115
10 X 8	XDMJRS1008		918.00	130
12 X 4	XDMJRS1204		918.00	130
12 X 6	XDMJRS1206		1,058.00	150
12 X 8	XDMJRS1208	12	1,163.00	165
12 X 10	XDMJRS1210		1,341.00	190
16 X 8	XDMJRS1608		1,742.00	230
16 X 12	XDMJRS1612		2,159.00	285
16 X 14	XDMJRS1614		4,285.00	310
18 X 12	XDMJRS1812		2,543.00	325
20 X 8	XDMJRS2008		5,576.00	345
20 X 12	XDMJRS2012		2,932.00	375
20 X 16	XDMJRS2016		3,399.00	435
20 X 18	XDMJRS2018		5,576.00	345
24 X 12	XDMJRS2412		3,985.00	510
24 X 14	XDMJRS2414		6,990.00	535
24 X 16	XDMJRS2416		4,491.00	575
24 X 18	XDMJRS2418		4,843.00	620
24 X 20	XDMJRS2420		5,192.00	665
30 X 16	XDMJRS3016		7,527.00	900
30 X 18	XDMJRS3018		7,403.00	885
30 X 20	XDMJRS3020		7,904.00	945
30 X 24	XDMJRS3024		8,864.00	1060
36 X 20	XDMJRS3620		18,629.00	1285
36 X 24	XDMJRS3624		21,115.00	1410
36 X 30	XDMJRS3630		14,131.00	1690
42 X 30	XDMJRS4230		28,958.00	2165
42 X 36	XDMJRS4236		30,928.00	2485
48 X 36	XDMJRS4836		27,642.00	3100

REDUCERS : MJ X FE

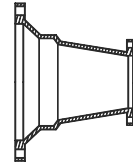

Size (in.)	Item No.	Crt. Qty.	List Price (\$)	Wt. (lb.)
4 X 3	XDMJFR0403	0	245.00	35
6 X 3	XDMJFR0603	0	374.00	49
6 X 4	XDMJFR0604	0	389.00	54
8 X 4	XDMJFR0804	0	525.00	75
8 X 6	XDMJFR0806	2	551.00	80
10 X 6	XDMJFR1006	0	645.00	105
10 X 8	XDMJFR1008	0	843.00	130
12 X 6	XDMJFR1206	0	843.00	145
12 X 8	XDMJFR1208	0	1,227.00	175
12 X 10	XDMJFR1210	0	1,197.00	185
14 X 6	XDMJFR1406	0	1,330.00	195
14 X 8	XDMJFR1408	0	1,635.00	215
14 X 12	XDMJFR1412	0	1,635.00	270
16 X 12	XDMJFR1612	0	2,588.00	325
18 X 8	XDMJFR1808	0	2,345.00	300
18 X 12	XDMJFR1812	0	3,167.00	360
18 X 16	XDMJFR1816	0	3,477.00	445
20 X 16	XDMJFR2016	0	3,985.00	510
24 X 12	XDMJFR2412	0	5,498.00	455

**REDUCERS : MJ
LARGE END (LEB)**

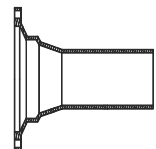

Size (in.)	Item No.	Crt. Qty.	List Price (\$)	Wt. (lb.)
4 X 3	XDMJRL0403		284.00	40
6 X 3	XDMJRL0603		389.00	55
6 X 4	XDMJRL0604		425.00	60
8 X 3	XDMJRL0803		540.00	70
8 X 4	XDMJRL0804		566.00	80
8 X 6	XDMJRL0806		694.00	98
10 X 6	XDMJRL1006		811.00	115
10 X 8	XDMJRL1008		918.00	130
12 X 4	XDMJRL1204		1,356.00	135
12 X 6	XDMJRL1206		1,024.00	145
12 X 8	XDMJRL1208		1,163.00	165
12 X 10	XDMJRL1210		1,306.00	185

Contd.....

CALL FOR BARE/BARE FITTINGS

**REDUCERS : MJ
LARGE END (LEB)**

Contd.....

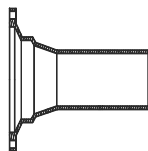

Size (in.)	Item No.	Crt. Qty.	List Price (\$)	Wt. (lb.)
16 X 8	XDMJRL1608		3,213.00	
16 X 10	XDMJRL1610		3,533.00	
16 X 12	XDMJRL1612		2,311.00	305
20 X 10	XDMJRL2010		4,206.00	375
20 X 16	XDMJRL2016		3,477.00	445
24 X 16	XDMJRL2416		4,648.00	595
24 X 20	XDMJRL2420		5,272.00	675
30 X 16	XDMJRL3016		11,751.00	910
30 X 18	XDMJRL3018		11,879.00	965
30 X 20	XDMJRL3020		8,529.00	1020
30 X 24	XDMJRL3024		9,409.00	1125
36 X 20	XDMJRL3620		11,875.00	1420
36 X 24	XDMJRL3624		12,838.00	1535
36 X 30	XDMJRL3630		13,970.00	1750
42 X 30	XDMJRL4230		31,541.00	2265
42 X 36	XDMJRL4236		34,958.00	2530
48 X 42	XDMJRL4842		59,156.00	3540

ADAPTERS : MJ X FLANGE

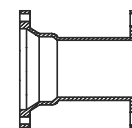

Size (in.)	Item No.	Crt. Qty.	List Price (\$)	Wt. (lb.)
3	XDMJFA03		216.00	30
4	XDMJFA04	16	284.00	40
6	XDMJFA06	8	425.00	60
8	XDMJFA08	8	604.00	85
10	XDMJFA10		994.00	115
12	XDMJFA12		1,232.00	155
14	XDMJFA14	4	1,477.00	195
16	XDMJFA16		1,969.00	240
18	XDMJFA18		2,352.00	280
20	XDMJFA20		2,855.00	340
24	XDMJFA24		3,576.00	455
30	XDMJFA30		6,357.00	760
36	XDMJFA36		8,950.00	1070
42	XDMJFA42		13,424.00	1505
48	XDMJFA48		17,304.00	1942

**HYDRANT ADAPTERS :
SWIVEL X SOLID
WITH SWIVEL GLAND
(ANCHOR COUPLING)**

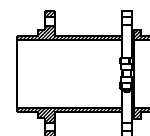

**HYDRANT ELL :
SWIVEL X SWIVEL
WITH TWO-SWIVEL GLAND**

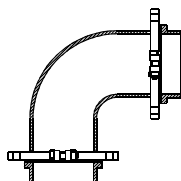

Size (in.)	Item No.	Crt. Qty.	List Price (\$)	Wt. (lb.)
6	XDMJHB9006	0	POA	87
8	XDMJHB9008	0	POA	158

Size (in.)	Item No.	Crt. Qty.	List Price (\$)	Wt. (lb.)
4 X 13	XDMJHA0413	60	POA	28
6 X 13	XDMJHA0613		POA	54
6 X 18	XDMJHA0618		POA	68
6 X 24	XDMJHA0624		POA	81
6 X 36	XDMJHA0636		POA	110
6 X 48	XDMJHA0648		POA	139
8 X 13	XDMJHA0813	27	POA	68
8 X 18	XDMJHA0818		POA	88
8 X 24	XDMJHA0824		POA	112
8 X 48	XDMJHA0848		POA	208
12 X 13	XDMJHA1213	12	POA	123

CALL FOR BARE/BARE FITTINGS

MJ CAPS : SOLID

Size (in.)	Item No.	Crt. Qty.	List Price (\$)	Wt. (lb.)
2	XDMJC02	100	73.00	5
3	XDMJC03	50	84.00	12
4	XDMJC04	18	106.00	20
6	XDMJC06	18	153.00	30
8	XDMJC08	18	269.00	45
10	XDMJC10	8	413.00	60
12	XDMJC12	8	555.00	80
14	XDMJC14	2	1,128.00	110
16	XDMJC16	2	1,136.00	155
18	XDMJC18	2	1,352.00	185
20	XDMJC20	2	1,851.00	200
24	XDMJC24	2	2,698.00	300
30	XDMJC30	0	4,938.00	590
36	XDMJC36	0	7,112.00	815
42	XDMJC42	0	10,525.00	1180
48	XDMJC48	0	14,223.00	1595

MJ CAPS : 2" TAPPED

Size (in.)	Item No.	Crt. Qty.	List Price (\$)	Wt. (lb.)
2	XDMJC02T	0	126.00	5
3	XDMJC03T	0	140.00	12
4	XDMJC04T	0	160.00	20
6	XDMJC06T	18	207.00	30
8	XDMJC08T	18	323.00	45
10	XDMJC10T	0	468.00	60
12	XDMJC12T	8	610.00	80
14	XDMJC14T	0	1,214.00	110
16	XDMJC16T	0	1,226.00	155
18	XDMJC18T	0	1,465.00	185
20	XDMJC20T	0	1,964.00	200
24	XDMJC24T	0	2,809.00	300
30	XDMJC30T	0	5,103.00	590
36	XDMJC36T	0	7,279.00	815
42	XDMJC42T	0	10,749.00	1180
48	XDMJC48T	0	14,451.00	1595

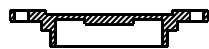
MJ PLUGS : SOLID

Size (in.)	Item No.	Crt. Qty.	List Price (\$)	Wt. (lb.)
2	XDMJP02	24	70.00	5
3	XDMJP03	0	73.00	10
4	XDMJP04	18	106.00	20
6	XDMJP06	18	172.00	30
8	XDMJP08	12	306.00	50
10	XDMJP10	8	448.00	65
12	XDMJP12	8	590.00	85
14	XDMJP14	0	874.00	115
16	XDMJP16	2	1,075.00	145
18	XDMJP18	0	935.00	180
20	XDMJP20	0	1,851.00	200
24	XDMJP24	0	2,619.00	290
30	XDMJP30	0	4,814.00	575
36	XDMJP36	0	6,818.00	815
42	XDMJP42	0	9,903.00	1110
48	XDMJP48	0	12,978.00	1455

MJ PLUGS : 2" TAPPED

Size (in.)	Item No.	Crt. Qty.	List Price (\$)	Wt. (lb.)
2	XDMJP02T		123.00	
3	XDMJP03T	0	126.00	10
4	XDMJP04T	18	160.00	20
6	XDMJP06T	120	228.00	30
8	XDMJP08T	100	359.00	50
10	XDMJP10T	8	500.00	65
12	XDMJP12T	40	645.00	85
14	XDMJP14T	0	961.00	115
16	XDMJP16T	0	1,162.00	145
18	XDMJP18T	0	1,048.00	180
20	XDMJP20T	0	1,964.00	200
24	XDMJP24T	0	2,730.00	290
30	XDMJP30T	0	4,978.00	575
36	XDMJP36T	0	6,985.00	815
42	XDMJP42T	0	11,298.00	1110
48	XDMJP48T	0	15,073.00	1455

CALL FOR BARE/BARE FITTINGS

Utility Pipe Fittings & Accessories

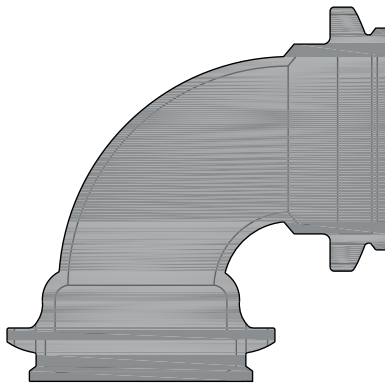

ANSI/AWWA C153/A21.53
COMPACT PUSH-ON FITTINGS

PRICE LIST

Effective December 16, 2024



**BENDS : PO X PO
90° (1/4)**

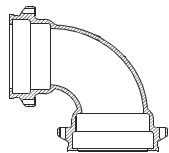

Size (in.)	Item No.	Crt. Qty.	List Price (\$)	Wt. (lb.)
4	CDPOB9004	60	237.00	28
6	CDPOB9006	32	379.00	44
8	CDPOB9008	18	560.00	71
10	CDPOB9010	12	753.00	100
12	CDPOB9012	6	1,252.00	140
14	CDPOB9014	0	1,807.00	254
16	CDPOB9016	4	3,214.00	280
18	CDPOB9018	0	4,467.00	482
20	CDPOB9020	0	5,000.00	640
24	CDPOB9024	2	6,240.00	710

**BENDS : PO X PO
45° (1/8)**

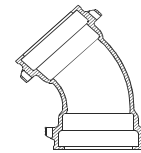

Size (in.)	Item No.	Crt. Qty.	List Price (\$)	Wt. (lb.)
4	CDPOB4504	75	217.00	23
6	CDPOB4506	36	321.00	38
8	CDPOB4508	27	469.00	54
10	CDPOB4510	18	717.00	84
12	CDPOB4512	8	955.00	110
14	CDPOB4514		1,437.00	150
16	CDPOB4516	4	2,230.00	210
18	CDPOB4518		2,557.00	309
20	CDPOB4520		3,675.00	397
24	CDPOB4524		4,558.00	455

**BENDS : PO X PO
22½° (1/16)**

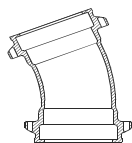

Size (in.)	Item No.	Crt. Qty.	List Price (\$)	Wt. (lb.)
4	CDPOB2204	75	207.00	22
6	CDPOB2206	48	288.00	34
8	CDPOB2208	27	385.00	55
10	CDPOB2210	18	608.00	70
12	CDPOB2212	8	800.00	90
14	CDPOB2214		1,437.00	162
16	CDPOB2216	4	2,103.00	220
18	CDPOB2218		2,838.00	209
20	CDPOB2220		3,837.00	414
24	CDPOB2224		5,184.00	455

**BENDS : PO X PO
11¼° (1/32)**

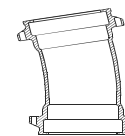

Size (in.)	Item No.	Crt. Qty.	List Price (\$)	Wt. (lb.)
4	CDPOB1104	75	209.00	21
6	CDPOB1106	48	288.00	32
8	CDPOB1108	25	395.00	52
10	CDPOB1110	18	590.00	70
12	CDPOB1112	8	788.00	95
14	CDPOB1114		1,437.00	113
16	CDPOB1116	4	2,179.00	170
18	CDPOB1118		2,846.00	209
20	CDPOB1120		3,496.00	265
24	CDPOB1124	2	7,611.00	315

**BENDS : PO X PE
90° (1/4)**

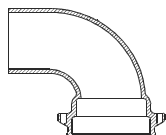

Size (in.)	Item No.	Crt. Qty.	List Price (\$)	Wt. (lb.)
4	CDPOPB9004	60	453.00	24
6	CDPOPB9006	32	429.00	48
8	CDPOPB9008		POA	

**BENDS : PO X PE
45° (1/8)**

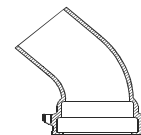

Size (in.)	Item No.	Crt. Qty.	List Price (\$)	Wt. (lb.)
4	CDPOPB4504	75	159.00	21
6	CDPOPB4506	36	345.00	38
8	CDPOPB4508	27	542.00	60

BENDS : PO X PE
22½° (1/16)

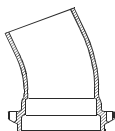

Size (in.)	Item No.	Crt. Qty.	List Price (\$)	Wt. (lb.)
4	CDPOPB2204		POA	
6	CDPOPB2206	48	321.00	35
8	CDPOPB2208	27	516.00	57

BENDS : PO X PE
11¼° (1/32)

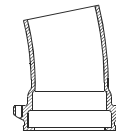

Size (in.)	Item No.	Crt. Qty.	List Price (\$)	Wt. (lb.)
4	CDPOPB1104		POA	
6	CDPOPB1106	48	327.00	35
8	CDPOPB1108	27	498.00	55

BENDS : PO X FE
90° (1/4)

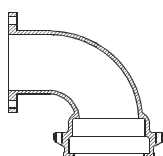

Size (in.)	Item No.	Crt. Qty.	List Price (\$)	Wt. (lb.)
4	CDPOFB9004	24	210.00	32
6	CDPOFB9006	36	523.00	49
8	CDPOFB9008	18	588.00	74
10	CDPOFB9010	16	1,002.00	130
12	CDPOFB9012	16	1,514.00	158
14	CDPOFB9014	0	1,431.00	231
16	CDPOFB9016	4	2,092.00	233

BENDS : PO X FE
45° (1/8)

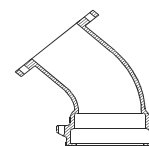

Size (in.)	Item No.	Crt. Qty.	List Price (\$)	Wt. (lb.)
4	CDPOFB4504	0	194.00	21
6	CDPOFB4506	36	411.00	42
8	CDPOFB4508	18	627.00	60
10	CDPOFB4510	0	840.00	93
12	CDPOFB4512	0	1,175.00	122
14	CDPOFB4514	0	1,459.00	162
16	CDPOFB4516	0	2,471.00	275

BENDS : PO X FE
22½° (1/16)

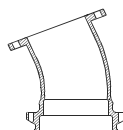

Size (in.)	Item No.	Crt. Qty.	List Price (\$)	Wt. (lb.)
4	CDPOFB2204	48	235.00	25
6	CDPOFB2206	36	308.00	44
8	CDPOFB2208	24	525.00	64
10	CDPOFB2210	12	717.00	90
12	CDPOFB2212	8	1,164.00	112
14	CDPOFB2214		1,459.00	174
16	CDPOFB2216		2,471.00	228

BENDS : PO X FE
11¼° (1/32)

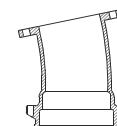

Size (in.)	Item No.	Crt. Qty.	List Price (\$)	Wt. (lb.)
4	CDPOFB1104	48	220.00	24
6	CDPOFB1106	36	308.00	30
8	CDPOFB1108	27	513.00	60
10	CDPOFB1110	12	674.00	80
12	CDPOFB1112	8	1,005.00	96
14	CDPOFB1114		1,531.00	170
16	CDPOFB1116		2,048.00	230

TEES : PO X PO

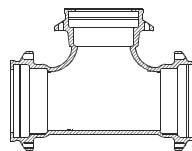

Size (in.)	Item No.	Crt. Qty.	List Price (\$)	Wt. (lb.)
4 X 4	CDPOT0404	48	341.00	46
6 X 4	CDPOT0604	24	434.00	58
6 X 6	CDPOT0606	24	457.00	66
8 X 4	CDPOT0804	16	577.00	93
8 X 6	CDPOT0806	18	645.00	103
8 X 8	CDPOT0808	18	754.00	109
10 X 4	CDPOT1004	18	893.00	95
10 X 6	CDPOT1006	12	963.00	129
10 X 8	CDPOT1008	8	1,145.00	141
10 X 10	CDPOT1010	8	1,420.00	145
12 X 4	CDPOT1204	12	1,113.00	115
12 X 6	CDPOT1206	8	1,006.00	164
12 X 8	CDPOT1208	8	1,261.00	166
12 X 10	CDPOT1210	4	1,438.00	175
12 X 12	CDPOT1212	4	1,400.00	193
14 X 6	CDPOT1406		1,414.00	176
14 X 10	CDPOT1410		3,117.00	195
14 X 12	CDPOT1412		3,159.00	196
14 X 14	CDPOT1414		3,040.00	209
16 X 6	CDPOT1606	2	2,628.00	231
16 X 8	CDPOT1608	4	2,857.00	265
16 X 10	CDPOT1610		2,972.00	232
16 X 12	CDPOT1612	4	3,381.00	300
16 X 14	CDPOT1614		4,537.00	349
16 X 16	CDPOT1616	4	4,038.00	261
18 X 6	CDPOT1806		3,227.00	348
18 X 8	CDPOT1808		3,012.00	325
18 X 10	CDPOT1810		3,189.00	344
18 X 12	CDPOT1812		POA	344
18 X 14	CDPOT1814		3,170.00	342
18 X 16	CDPOT1816		3,354.00	362
18 X 18	CDPOT1818		POA	377
20 X 6	CDPOT2006		3,289.00	355
20 X 10	CDPOT2010		3,420.00	369
20 X 12	CDPOT2012		POA	425
20 X 14	CDPOT2014		4,485.00	484
20 X 16	CDPOT2016		5,649.00	510
20 X 18	CDPOT2018		4,991.00	539
20 X 20	CDPOT2020		POA	564

Size (in.)	Item No.	Crt. Qty.	List Price (\$)	Wt. (lb.)
24 X 6	CDPOT2406		4,315.00	450
24 X 8	CDPOT2408		POA	492
24 X 10	CDPOT2410		4,428.00	478
24 X 12	CDPOT2412		6,140.00	541
24 X 14	CDPOT2414		5,018.00	542
24 X 16	CDPOT2416		5,242.00	566
24 X 18	CDPOT2418	2	5,493.00	593
24 X 20	CDPOT2420		5,815.00	628
24 X 24	CDPOT2424		8,185.00	884

TEES : PO X FE

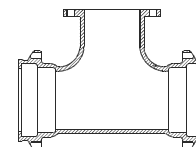

Size (in.)	Item No.	Crt. Qty.	List Price (\$)	Wt. (lb.)
4 X 4	CDPOFT0404	24	369.00	42
6 X 4	CDPOFT0604	24	473.00	59
6 X 6	CDPOFT0606	24	495.00	67
8 X 4	CDPOFT0804	18	636.00	79
8 X 6	CDPOFT0806	18	644.00	85
8 X 8	CDPOFT0808	18	787.00	105
10 X 4	CDPOFT1004	18	855.00	97
10 X 6	CDPOFT1006	8	1,100.00	102
10 X 8	CDPOFT1008	8	1,220.00	128
10 X 10	CDPOFT1010	8	1,244.00	165
12 X 4	CDPOFT1204	12	1,100.00	125
12 X 6	CDPOFT1206	8	1,092.00	135
12 X 8	CDPOFT1208	8	1,299.00	155
12 X 10	CDPOFT1210	4	1,370.00	142
12 X 12	CDPOFT1212	4	1,851.00	210
14 X 6	CDPOFT1406		2,223.00	212
14 X 8	CDPOFT1408		3,359.00	265
14 X 10	CDPOFT1410		3,011.00	246
14 X 12	CDPOFT1412		3,587.00	296
14 X 14	CDPOFT1414		3,875.00	321
16 X 6	CDPOFT1606	8	2,383.00	236
16 X 8	CDPOFT1608	8	2,950.00	269
16 X 10	CDPOFT1610		2,963.00	330

Contd.....

TEES : PO X FE
Contd.....

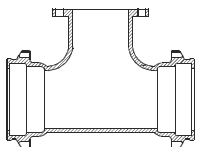

Size (in.)	Item No.	Crt. Qty.	List Price (\$)	Wt. (lb.)
16 X 12	CDPOFT1612	4	2,881.00	348
16 X 14	CDPOFT1614		4,112.00	342
16 X 16	CDPOFT1616	4	4,265.00	355
18 X 6	CDPOFT1806		2,789.00	301
18 X 8	CDPOFT1808		2,957.00	319
18 X 10	CDPOFT1810		3,123.00	337
18 X 14	CDPOFT1814		3,640.00	393
18 X 16	CDPOFT1816		3,892.00	420
20 X 6	CDPOFT2006		3,159.00	341
20 X 10	CDPOFT2010		4,088.00	420
20 X 14	CDPOFT2014		4,613.00	474
20 X 16	CDPOFT2016		4,845.00	498
20 X 18	CDPOFT2018		7,728.00	528
24 X 6	CDPOFT2406		4,977.00	512
24 X 8	CDPOFT2408		6,497.00	594
24 X 10	CDPOFT2410		4,553.00	468
24 X 12	CDPOFT2412		4,892.00	503
24 X 14	CDPOFT2414		5,162.00	531
24 X 16	CDPOFT2416		5,398.00	555

HYDRANT TEES : PO X SWIVEL

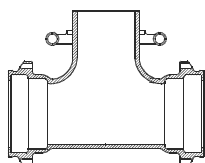

Size (in.)	Item No.	Crt. Qty.	List Price (\$)	Wt. (lb.)
6 X 6	CDPOHT0606	24	525.00	70
8 X 6	CDPOHT0806	24	899.00	90
8 X 8	CDPOHT0808		990.00	110
10X 6	CDPOHT1006		1,171.00	100
10X 8	CDPOHT1008		1,403.00	156
12X 6	CDPOHT1206	16	1,415.00	138
12X 8	CDPOHT1208		1,421.00	158
14X 6	CDPOHT1406		1,817.00	202
16X 6	CDPOHT1606	2	2,059.00	230
16X 8	CDPOHT1608		2,621.00	292
18X 6	CDPOHT1806		3,227.00	348
18X 8	CDPOHT1808		3,002.00	324
20X 6	CDPOHT2006		3,704.00	400
24X 6	CDPOHT2406		4,861.00	525

PO CROSSES

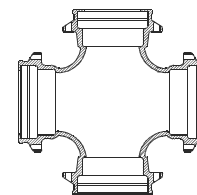

Size (in.)	Item No.	Crt. Qty.	List Price (\$)	Wt. (lb.)
4 X 4	CDPOX0404		546.00	56
6 X 4	CDPOX0604		644.00	69
6 X 6	CDPOX0606	12	595.00	83
8 X 4	CDPOX0804		1,135.00	117
8 X 6	CDPOX0806	12	884.00	115
8 X 8	CDPOX0808	12	999.00	128
10 X 4	CDPOX1004		1,113.00	116
10 X 6	CDPOX1006		1,678.00	
10 X 8	CDPOX1008		2,046.00	159
10 X 10	CDPOX1010		1,646.00	165
12 X 8	CDPOX1208	8	1,414.00	197
12 X 10	CDPOX1210		1,869.00	195
12 X 12	CDPOX1212		1,908.00	241
14 X 6	CDPOX1406		1,702.00	189
14 X 8	CDPOX1408		1,834.00	204
14 X 10	CDPOX1410		1,994.00	222
14 X 12	CDPOX 1412		2,148.00	239
14 X 14	CDPOX1414		2,424.00	270
16 X 6	CDPOX1606		2,103.00	234
16 X 8	CDPOX1608		2,899.00	323
16 X 10	CDPOX1610		POA	268
16 X 12	CDPOX1612		2,463.00	274
16 X 14	CDPOX 1614		POA	322
16 X 16	CDPOX1616		2,844.00	317
24 X 24	CDPOX2424		POA	1178

TEES : PO X PE

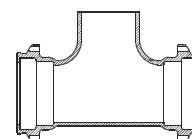

Size (in.)	Item No.	Crt. Qty.	List Price (\$)	Wt. (lb.)
6 X 6	CDPOPET0606	24	683.00	60
8 X 6	CDPOPET0806	18	1,040.00	75
12X 6	CDPOPET1206	8	1,546.00	132

TEES : PO TAPPED 2"

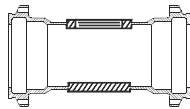

Size (in.)	Item No.	Crt. Qty.	List Price (\$)	Wt. (lb.)
4	CDPOTT04		302.00	27
6	CDPOTT06		398.00	38
8	CDPOTT08		587.00	59
10	CDPOTT10		702.00	72
12	CDPOTT12		884.00	92

PO FLANGE ADAPTER

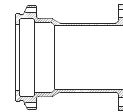

Size (in.)	Item No.	Crt. Qty.	List Price (\$)	Wt. (lb.)
4	CDPOFA04	80	206.00	22
6	CDPOFA06	48	321.00	34
8	CDPOFA08	36	431.00	50
10	CDPOFA10	24	545.00	70
12	CDPOFA12	16	855.00	80
14	CDPOFA14		1,552.00	113
16	CDPOFA16	8	1,718.00	180
18	CDPOFA18		2,493.00	226
20	CDPOFA20		2,737.00	264
24	CDPOFA24	4	5,363.00	308

PO LATERAL WYES

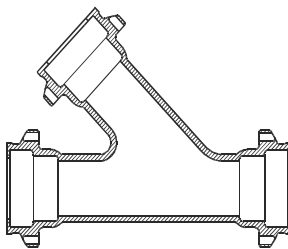

Size (in.)	Item No.	Crt. Qty.	List Price (\$)	Wt. (lb.)
4 X 4	CDPOL0404	8	323.00	55
6 X 4	CDPOL0604	8	738.00	75
6 X 6	CDPOL0606	8	912.00	83
8 X 4	CDPOL0804		919.00	90
8 X 6	CDPOL0806	8	1,254.00	125
8 X 8	CDPOL0808	8	1,494.00	140
10X 4	CDPOL1004		1,045.00	141
10X 6	CDPOL1006		1,364.00	155
10X 8	CDPOL1008		1,806.00	160
10X10	CDPOL1010	4	1,622.00	170
12X 4	CDPOL1204		1,725.00	178
12X 6	CDPOL1206		1,807.00	234
12X 8	CDPOL1208		1,979.00	260
12X10	CDPOL1210		2,176.00	280
12X12	CDPOL1212	3	2,114.00	300
14X 6	CDPOL1406		2,120.00	236
14X 8	CDPOL1408		2,290.00	255
14X10	CDPOL1410		2,917.00	325
14X14	CDPOL1414		4,261.00	475
16X 6	CDPOL1606		2,525.00	281
16X 8	CDPOL1608		2,728.00	304
16X12	CDPOL1612		3,102.00	346
16X16	CDPOL1616		3,409.00	380

REDUCERS : PO X PO

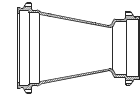

Size (in.)	Item No.	Crt. Qty.	List Price (\$)	Wt. (lb.)
6 X 4	CDPOR0604	60	237.00	30
8 X 4	CDPOR0804	36	340.00	40
8 X 6	CDPOR0806	36	345.00	40
10X 4	CDPOR1004		652.00	55
10X 6	CDPOR1006		510.00	60
10X 8	CDPOR1008	18	565.00	65
12X 4	CDPOR1204	12	717.00	70
12X 6	CDPOR1206	18	605.00	75
12X 8	CDPOR1208	12	657.00	80
12X10	CDPOR1210	12	787.00	107
14X 6	CDPOR1406		660.00	84
14X 8	CDPOR1408		670.00	85
14X10	CDPOR1410		687.00	87
14X12	CDPOR1412		817.00	104
16X 6	CDPOR1606	4	1,385.00	138
16X 8	CDPOR1608	4	1,437.00	137
16X10	CDPOR1610	4	1,406.00	130
16X12	CDPOR1612	4	1,484.00	135
16X14	CDPOR1614		1,251.00	139
18X 8	CDPOR1808		1,320.00	142
18X10	CDPOR1810		1,402.00	151
18X12	CDPOR1812		1,554.00	167
18X14	CDPOR1814		2,014.00	217

Contd.....

REDUCERS : PO X PO

Contd.....

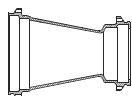

Size (in.)	Item No.	Crt. Qty.	List Price (\$)	Wt. (lb.)
18X16	CDPOR1816		1,876.00	202
20X10	CDPOR2010		1,671.00	180
20X12	CDPOR2012		1,904.00	205
20X14	CDPOR2014		2,159.00	233
20X16	CDPOR2016		2,319.00	250
20X18	CDPOR2018		2,300.00	248
24X12	CDPOR2412		2,282.00	337
24X14	CDPOR2414		2,608.00	339
24X16	CDPOR2416		3,520.00	340
24X18	CDPOR2418		3,613.00	390
24X20	CDPOR2420		3,899.00	421

REDUCERS : PO X FE

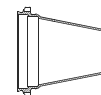

Size (in.)	Item No.	Crt. Qty.	List Price (\$)	Wt. (lb.)
6 X 4	CDPOFR0604	16	296.00	32
8 X 4	CDPOFR0804	16	448.00	46
8 X 6	CDPOFR0806	36	434.00	47
10X 4	CDPOFR1004		498.00	55
10X 6	CDPOFR1006	12	533.00	59
10X 8	CDPOFR1008	18	881.00	60
12X 4	CDPOFR1204		702.00	78
12X 6	CDPOFR1206	8	678.00	73
12X 8	CDPOFR1208	8	670.00	74
12X10	CDPOFR1210		857.00	95
14X 6	CDPOFR1406		1,090.00	121
14X 8	CDPOFR1408		1,154.00	128
14X10	CDPOFR1410		1,145.00	127
14X12	CDPOFR1412		1,296.00	144
16X 6	CDPOFR1606		1,198.00	136
16X 8	CDPOFR1608		1,270.00	144
16X10	CDPOFR1610		1,421.00	160
16X12	CDPOFR1612	4	1,546.00	170
16X14	CDPOFR1614		1,763.00	196
18X 8	CDPOFR1808		1,460.00	157
18X10	CDPOFR1810		1,626.00	175
18X12	CDPOFR1812		1,997.00	215
18X14	CDPOFR1814		2,171.00	234
18X16	CDPOFR1816		2,282.00	246
20X10	CDPOFR2010		2,171.00	234
20X14	CDPOFR2014		2,311.00	249
20X16	CDPOFR2016		2,521.00	272
24X12	CDPOFR2412		2,430.00	262
24X14	CDPOFR2414		2,918.00	315
24X16	CDPOFR2416		3,040.00	328

PUSH-ON GASKET



Size (in.)	Item No.	Crt. Qty.	List Price (\$)	Wt. (lb.)
4	6655.04	180	11.00	0.4
6	6655.06	100	13.00	0.6
8	6655.08	80	15.00	0.7
10	6655.1	60	22.00	0.9
12	6655.12	60	25.00	1
14	6655.14	60	50.00	1.3
16	6655.16	50	50.00	1.5
18			70.00	
20			75.00	
24			75.00	

TRANSITION PUSH-ON GASKET

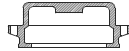

Size (in.)	Item No.	Crt. Qty.	List Price (\$)	Wt. (lb.)
4	6656.04	180	65.00	0.4
6	6656.06	100	72.00	0.6
8	6656.08	80	120.00	0.7
10	6656.10	60	146.00	0.9
12	6656.12	60	198.00	1.0

PO CAPS SOLID

Size (in.)	Item No.	Crt. Qty.	List Price (\$)	Wt. (lb.)
4	CDPOC04	120	106.00	13
6	CDPOC06	72	162.00	20
8	CDPOC08	54	249.00	32
10	CDPOC10	36	318.00	40
12	CDPOC12	24	465.00	63
14	CDPOC14		POA	70
16	CDPOC16	12	POA	110
18	CDPOC18		POA	120
20	CDPOC20		POA	150
24	CDPOC24	4	POA	216

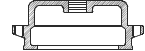
PO CAPS TAPPED

Size (in.)	Item No.	Crt. Qty.	List Price (\$)	Wt. (lb.)
4	CDPOCT04	120	160.00	13
6	CDPOCT06	72	216.00	20
8	CDPOCT08	54	302.00	32
10	CDPOCT10	36	373.00	40
12	CDPOCT12	24	516.00	63
14	CDPOCT14		POA	70
16	CDPOCT16	12	POA	110
18	CDPOCT18		POA	120
20	CDPOCT20		POA	150
24	CDPOCT24		POA	216

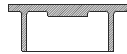
PO PLUGS SOLID

Size (in.)	Item No.	Crt. Qty.	List Price (\$)	Wt. (lb.)
4	CDPOP04	200	82.00	12
6	CDPOP06	96	132.00	18
8	CDPOP08	72	179.00	29
10	CDPOP10	36	277.00	35
12	CDPOP12	30	317.00	46
14	CDPOP14		1,096.00	74
16	CDPOP16	20	3,153.00	60
18	CDPOP18		3,011.00	120
20	CDPOP20		2,591.00	145
24	CDPOP24	4	3,644.00	204

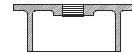
PO PLUGS TAPPED

Size (in.)	Item No.	Crt. Qty.	List Price (\$)	Wt. (lb.)
4	CDPOPT04	100	116.00	12
6	CDPOPT06	72	188.00	18
8	CDPOPT08	54	232.00	29
10	CDPOPT10	36	330.00	35
12	CDPOPT12	24	369.00	46
14	CDPOPT14		1,287.00	74
16	CDPOPT16	8	3,706.00	60
18	CDPOPT18		3,539.00	120
20	CDPOPT20		3,046.00	145
24	CDPOPT24	4	3,232.00	204

Utility Pipe Fittings & Accessories

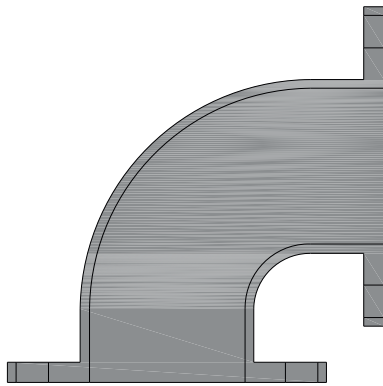

ANSI/AWWA C110/A21.10
FLANGE FITTINGS

PRICE LIST

Effective December 16, 2024



FLANGE BENDS
90° (1/4)

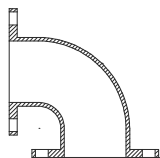

Size (in.)	Item No.	List Price (\$)	Wt. (lb.)
2	DFB9002	143.00	14
3	DFB9003	165.00	25
4	DFB9004	255.00	45
5	DFB9005	POA	62
6	DFB9006	394.00	65
8	DFB9008	644.00	105
10	DFB9010	1,022.00	165
12	DFB9012	1,328.00	235
14	DFB9014	1,747.00	290
16	DFB9016	2,153.00	370
18	DFB9018	3,002.00	450
20	DFB9020	3,672.00	580
24	DFB9024	6,050.00	900
30	DFB9030	10,659.00	1430
36	DFB9036	15,620.00	2135
42	DFB9042	27,244.00	3055
48	DFB9048	36,516.00	4095
54	DFB9054	POA	3740
64	DFB9064	POA	6752

FLANGE BENDS
45° (1/8)

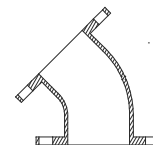

Size (in.)	Item No.	List Price (\$)	Wt. (lb.)
2	DFB4502	153.00	12
3	DFB4503	128.00	20
4	DFB4504	228.00	40
5	DFB4505	POA	52
6	DFB4506	350.00	55
8	DFB4508	532.00	90
10	DFB4510	859.00	130
12	DFB4512	1,122.00	195
14	DFB4514	1,328.00	220
16	DFB4516	1,689.00	280
18	DFB4518	2,358.00	325
20	DFB4520	3,085.00	430
24	DFB4524	4,284.00	630
30	DFB4530	9,366.00	1120
36	DFB4536	14,677.00	1755
42	DFB4542	23,183.00	2600
48	DFB4548	31,925.00	3580
54	DFB4554	POA	2735

FLANGE BENDS
22½° (1/16)

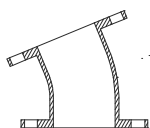

Size (in.)	Item No.	List Price (\$)	Wt. (lb.)
2	DFB2202	207.00	12
3	DFB2203	145.00	20
4	DFB2204	227.00	40
6	DFB2206	334.00	55
8	DFB2208	520.00	90
10	DFB2210	822.00	135
12	DFB2212	1,204.00	205
14	DFB2214	1,584.00	225
16	DFB2216	1,746.00	285
18	DFB2218	2,431.00	335
20	DFB2220	3,399.00	435
24	DFB2224	4,997.00	640
30	DFB2230	9,492.00	1135
36	DFB2236	14,970.00	1790
42	DFB2242	23,766.00	2665
48	DFB2248	32,684.00	3665
54	DFB2254	POA	2260

FLANGE BENDS
11¼° (1/32)

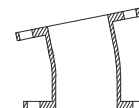

Size (in.)	Item No.	List Price (\$)	Wt. (lb.)
2	DFB1102	207.00	12
3	DFB1103	145.00	20
4	DFB1104	272.00	40
6	DFB1106	421.00	55
8	DFB1108	555.00	90
10	DFB1110	953.00	135
12	DFB1112	1,447.00	205
14	DFB1114	1,647.00	225
16	DFB1116	2,005.00	285
18	DFB1118	2,431.00	335
20	DFB1120	3,399.00	435
24	DFB1124	5,251.00	645
30	DFB1130	9,619.00	1150
36	DFB1136	15,094.00	1805
42	DFB1142	23,900.00	2680
48	DFB1148	32,950.00	3695
54	DFB1154	POA	2100

CALL FOR BARE/BARE FITTINGS

90° LONG RADIUS BENDS

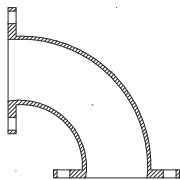

Size (in.)	Item No.	List Price (\$)	Wt. (lb.)
3	DFBLR9003	216.00	30
4	DFBLR9004	357.00	30
5	DFBLR9005	POA	76
6	DFBLR9006	619.00	80
8	DFBLR9008	1,024.00	140
10	DFBLR9010	1,514.00	215
12	DFBLR9012	2,284.00	325
14	DFBLR9014	2,708.00	580
16	DFBLR9016	3,550.00	740
18	DFBLR9018	4,570.00	840
20	DFBLR9020	6,326.00	928
24	DFBLR9024	9,678.00	1640
30	DFBLR9030	17,601.00	2105
36	DFBLR9036	27,465.00	3285
42	DFBLR9042	43,383.00	4865
48	DFBLR9048	60,547.00	7800
54	DFBLR9054	POA	6205

90° FLANGE X FLARE BENDS

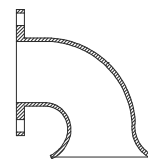

Size (in.)	Item No.	List Price (\$)	Wt. (lb.)
3	DFF9003	182.00	25
4	DFF9004	323.00	40
6	DFF9006	497.00	70
8	DFF9008	845.00	110
10	DFF9010	1,376.00	175
12	DFF9012	1,725.00	245
14	DFF9014	2,391.00	340
16	DFF9016	3,232.00	460
18	DFF9018	4,062.00	560
20	DFF9020	5,465.00	700
24	DFF9024	7,768.00	1100
30	DFF9030	16,472.00	1840
36	DFF9036	22,824.00	2700
42	DFF9042	28,535.00	3250
48	DFF9048	46,680.00	4215
54	DFF9054	POA	3965

STRAIGHT FLANGE X FLARE

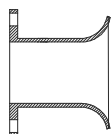

Size (in.)	Item No.	List Price (\$)	Wt. (lb.)
3	DFP03	145.00	20
4	DFP04	216.00	30
6	DFP06	284.00	40
8	DFP08	497.00	70
10	DFP10	672.00	95
12	DFP12	1,092.00	115
14	DFP14	1,163.00	190
16	DFP16	1,689.00	330
18	DFP18	1,998.00	355
20	DFP20	2,783.00	460
24	DFP24	3,750.00	635
30	DFP30	9,201.00	1025
36	DFP36	12,208.00	1460
42	DFP42	15,609.00	1900
48	DFP48	21,179.00	2350
54	DFP54	POA	2035

LONG RADIUS 90° FLANGE X FLARE BENDS

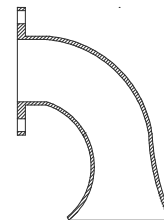

Size (in.)	Item No.	List Price (\$)	Wt. (lb.)
3	DFFLR9003	250.00	30
4	DFFLR9004	357.00	50
6	DFFLR9006	637.00	90
8	DFFLR9008	1,092.00	115
10	DFFLR9010	1,761.00	250
12	DFFLR9012	2,637.00	375
14	DFFLR9014	3,513.00	500
16	DFFLR9016	5,021.00	715
18	DFFLR9018	5,798.00	800
20	DFFLR9020	8,896.00	1140
24	DFFLR9024	10,422.00	1335
30	DFFLR9030	18,312.00	2190
36	DFFLR9036	28,971.00	3465
42	DFFLR9042	45,922.00	5150
48	DFFLR9048	59,963.00	6725

CALL FOR BARE/BARE FITTINGS

90° REDUCING BENDS

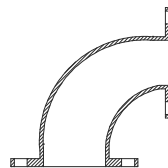

Size (in.)	Item No.	List Price (\$)	Wt. (lb.)
4 X 3	DFBR0403	210.00	35
6 X 3	DFBR0603	396.00	45
6 X 4	DFBR0604	389.00	55
6 X 5	DFBR0605	396.00	65
8 X 4	DFBR0804	532.00	80
8 X 5	DFBR0805	856.00	100
8 X 6	DFBR0806	604.00	90
10X 4	DFBR1004	918.00	105
10X 6	DFBR1006	953.00	125
10X 8	DFBR1008	1,058.00	150
12X 4	DFBR1204	988.00	145
12X 6	DFBR1206	1,128.00	165
12X 8	DFBR1208	1,341.00	190
12X10	DFBR1210	1,406.00	220
14X 6	DFBR1406	1,341.00	144
14X 8	DFBR1408	1,514.00	200
14X10	DFBR1410	1,689.00	260
14X12	DFBR1412	1,902.00	270
16X 6	DFBR1606	1,547.00	220
16X 8	DFBR1608	1,689.00	240
16X10	DFBR1610	1,969.00	344
16X12	DFBR1612	2,179.00	373
16X14	DFBR1614	2,355.00	330
18X 6	DFBR1806	1,888.00	260
18X 8	DFBR1808	2,358.00	280
18X10	DFBR1810	2,397.00	320
18X12	DFBR1812	2,543.00	465
18X14	DFBR1814	2,795.00	370
18X16	DFBR1816	3,047.00	410
20X 6	DFBR2006	2,502.00	320
20X 8	DFBR2008	2,698.00	345
20X10	DFBR2010	3,477.00	385
20X12	DFBR2012	3,611.00	415
20X14	DFBR2014	4,047.00	518
20X16	DFBR2016	3,868.00	533
20X18	DFBR2018	4,103.00	515
24X 6	DFBR2406	3,750.00	480
24X 8	DFBR2408	3,946.00	505
24X10	DFBR2410	4,256.00	545
24X12	DFBR2412	4,491.00	575
24X14	DFBR2414	4,960.00	595
24X16	DFBR2416	5,349.00	635
24X18	DFBR2418	5,427.00	675

Size (in.)	Item No.	List Price (\$)	Wt. (lb.)
24X20	DFBR2420	5,777.00	740
30X12	DFBR3012	7,024.00	840
30X14	DFBR3014	8,563.00	860
30X16	DFBR3016	7,527.00	900
30X18	DFBR3018	11,740.00	940
30X20	DFBR3020	12,406.00	1005
30X24	DFBR3024	10,080.00	1165
36X12	DFBR3612	9,994.00	1195
36X14	DFBR3614	13,293.00	1215
36X16	DFBR3616	10,496.00	1255
36X18	DFBR3618	14,044.00	1295
36X20	DFBR3620	14,515.00	1315
36X24	DFBR3624	13,256.00	1520
36X30	DFBR3630	15,385.00	1785
42X12	DFBR4212	POA	1655
42X14	DFBR4214	18,486.00	1675
42X16	DFBR4216	15,297.00	1715
42X18	DFBR4218	21,045.00	1755
42X20	DFBR4220	20,566.00	1820
42X24	DFBR4224	17,660.00	1980
42X30	DFBR4230	20,914.00	2245
42X36	DFBR4236	30,231.00	2600
48X12	DFBR4812	19,397.00	2175
48X14	DFBR4814	23,874.00	2195
48X16	DFBR4816	19,931.00	2235
48X18	DFBR4818	29,480.00	2275
48X20	DFBR4820	32,045.00	2340
48X24	DFBR4824	28,894.00	2500
48X30	DFBR4830	31,391.00	2765
48X36	DFBR4836	32,263.00	3115
48X42	DFBR4842	41,775.00	3580
54X12	DFBR5412	POA	1990
54X14	DFBR5414	POA	2015
54X16	DFBR5416	POA	2055
54X18	DFBR5418	POA	2095
54X20	DFBR5420	POA	2160
54X24	DFBR5424	POA	2320
54X30	DFBR5430	POA	2585
54X36	DFBR5436	POA	2940
54X42	DFBR5442	POA	3395
54X48	DFBR5448	POA	3565

CALL FOR BARE/BARE FITTINGS

90° BASE BENDS

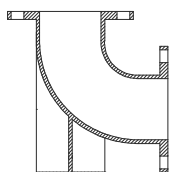

Size (in.)	Item No.	List Price (\$)	Wt. (lb.)
3	DFBB9003	250.00	35
4	DFBB9004	389.00	55
6	DFBB9006	551.00	85
8	DFBB9008	1,070.00	145
10	DFBB9010	1,477.00	210
12	DFBB9012	2,101.00	300
14	DFBB9014	2,532.00	320
16	DFBB9016	3,128.00	445
18	DFBB9018	4,100.00	565
20	DFBB9020	5,465.00	700
24	DFBB9024	8,039.00	1030
30	DFBB9030	13,587.00	1625
36	DFBB9036	19,942.00	2385
42	DFBB9042	38,432.00	3465
48	DFBB9048	41,109.00	4610
54	DFBB9054	POA	4415

90° LONG RADIUS BASE BENDS

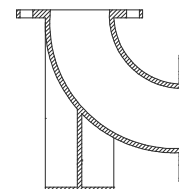

Size (in.)	Item No.	List Price (\$)	Wt. (lb.)
3	DFBBLR9003	272.00	40
4	DFBBLR9004	425.00	60
6	DFBBLR9006	704.00	100
8	DFBBLR9008	1,269.00	180
10	DFBBLR9010	1,828.00	260
12	DFBBLR9012	2,931.00	390
14	DFBBLR9014	2,931.00	650
16	DFBBLR9016	5,196.00	815
18	DFBBLR9018	5,798.00	955
20	DFBBLR9020	7,690.00	1200
24	DFBBLR9024	11,162.00	1770
30	DFBBLR9030	20,064.00	2295
36	DFBBLR9036	30,765.00	3535
42	DFBBLR9042	49,177.00	5275
48	DFBBLR9048	68,076.00	7305
54	DFBBLR9054	POA	6880

BASE TEES

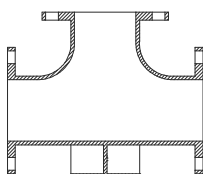

Size (in.)	Item No.	List Price (\$)	Wt. (lb.)
3	DFTB0303	323.00	45
4	DFTB0404	532.00	75
6	DFTB0606	776.00	110
8	DFTB0808	1,306.00	185
10	DFTB1010	2,110.00	300
12	DFTB1212	3,021.00	430
14	DFTB1414	3,409.00	500
16	DFTB1616	4,216.00	600
18	DFTB1818	5,365.00	740
20	DFTB2020	7,260.00	930
24	DFTB2424	11,006.00	1410
30	DFTB3030	18,979.00	2270
36	DFTB3636	27,755.00	3320
42	DFTB4242	52,162.00	5850
48	DFTB4848	68,838.00	7720
54	DFTB5454	POA	6465

CALL FOR BARE/BARE FITTINGS

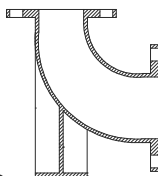
90° REDUCING BASE BENDS
 (WITH BASE UNDER SMALL END)

R - Available multiple size reductions.

Size (in.)	Item No.	List Price (\$)	Wt. (lb.)
4 X 3	DFBBSDR0403	POA	45
6 X 4	DFBBSDR0604	POA	75
8 X 4	DFBBSDR0804	POA	120
8 X 6	DFBBSDR0806	POA	130
10X 6	DFBBSDR1006	POA	170
10X 8	DFBBSDR1008	POA	195
12X 6	DFBBSDR1206	POA	230
12X 8	DFBBSDR1208	POA	255
12X10	DFBBSDR1210	POA	285
14X R	DFBBSDR14	POA	
16X R	DFBBSDR16	POA	
18X R	DFBBSDR18	POA	
20X R	DFBBSDR20	POA	
24X R	DFBBSDR24	POA	
30X R	DFBBSDR30	POA	
36X R	DFBBSDR36	POA	
42X R	DFBBSDR42	POA	
48X R	DFBBSDR48	POA	
54X R	DFBBSDR54	POA	

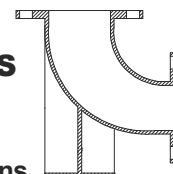
90° REDUCING BASE BENDS
 (WITH BASE UNDER LARGE END)

R - Available multiple size reductions.

Size (in.)	Item No.	List Price (\$)	Wt. (lb.)
4 X 3	DFBBLDR0403	POA	45
6 X 4	DFBBLDR0604	POA	75
8 X 4	DFBBLDR0804	POA	120
8 X 6	DFBBLDR0806	POA	130
10X 6	DFBBLDR1006	POA	170
10X 8	DFBBLDR1008	POA	195
12X 6	DFBBLDR1206	POA	230
12X 8	DFBBLDR1208	POA	255
12X10	DFBBLDR1210	POA	285
14X R	DFBBLDR14	POA	
16X R	DFBBLDR16	POA	
18X R	DFBBLDR18	POA	
20X R	DFBBLDR20	POA	
24X R	DFBBLDR24	POA	
30X R	DFBBLDR30	POA	
36X R	DFBBLDR36	POA	
42X R	DFBBLDR42	POA	
48X R	DFBBLDR48	POA	
54X R	DFBBLDR54	POA	

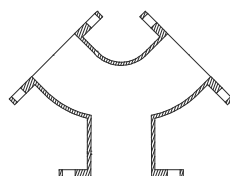
TRUE WYES

Size (in.)	Item No.	List Price (\$)	Wt. (lb.)
4 X 4 X 4	DFYT040404	357.00	50
6 X 4 X 4	DFYT060404	POA	75
6 X 6 X 6	DFYT060606	566.00	80
8 X 8 X 4	DFYT080804	604.00	87
8 X 6 X 6	DFYT080606	POA	120
8 X 8 X 8	DFYT080808	988.00	125
10 X 10 X 6	DFYT101006	988.00	142
10 X 8 X 8	DFYT100808	1,092.00	155
10 X 10 X 10	DFYT101010	1,306.00	185
12 X 12 X 6	DFYT121206	1,128.00	173
12 X 12 X 8	DFYT121208	1,477.00	225

Size (in.)	Item No.	List Price (\$)	Wt. (lb.)
12 X 12 X 10	DFYT121210	1,689.00	300
12 X 12 X 12	DFYT121212	2,110.00	300
14 X 14 X 14	DFYT141414	2,917.00	415
16 X 16 X 16	DFYT161616	4,076.00	580
18 X 18 X 18	DFYT181818	4,932.00	680
20 X 20 X 20	DFYT202020	7,494.00	960
24 X 24 X 24	DFYT242424	10,693.00	1370
30 X 30 X 30	DFYT303030	POA	80
36 X 36 X 36	DFYT363636	POA	120
42 X 42 X 42	DFYT424242	POA	125
48 X 48 X 48	DFYT484848	POA	120

CALL FOR BARE/BARE FITTINGS

FLANGE TEES

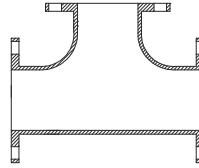

Size (in.)	Item No.	List Price (\$)	Wt. (lb.)
2 X 2	DFT0202	179.00	20
2½ X 2½	DFT02.5	POA	30
3 X 2	DFT0302	250.00	35
3 X 3	DFT0303	235.00	40
4 X 2	DFT0402	357.00	50
4 X 3	DFT0403	425.00	60
4 X 4	DFT0404	465.00	65
5 X 5	DFT0505	POA	80
6 X 2	DFT0602	604.00	156
6 X 3	DFT0603	604.00	85
6 X 4	DFT0604	637.00	90
6 X 6	DFT0606	577.00	95
8 X 3	DFT0803	974.00	130
8 X 4	DFT0804	893.00	140
8 X 6	DFT0806	829.00	145
8 X 8	DFT0808	960.00	155
10 X 4	DFT1004	1,281.00	205
10 X 6	DFT1006	1,197.00	215
10 X 8	DFT1008	1,254.00	225
10 X 10	DFT1010	1,459.00	270
12 X 4	DFT1204	1,739.00	290
12 X 6	DFT1206	1,672.00	295
12 X 8	DFT1208	1,761.00	310
12 X 10	DFT1210	2,099.00	360
12 X 12	DFT1212	2,117.00	385
14 X 4	DFT1404	POA	370
14 X 6	DFT1406	2,637.00	375
14 X 8	DFT1408	2,742.00	390
14 X 10	DFT1410	2,811.00	400
14 X 12	DFT1412	2,986.00	425
14 X 14	DFT1414	3,057.00	435
16 X 4	DFT1604	4,613.00	460
16 X 6	DFT1606	3,035.00	465
16 X 8	DFT1608	2,935.00	475
16 X 10	DFT1610	3,447.00	495
16 X 12	DFT1612	3,281.00	520
16 X 14	DFT1614	3,724.00	530
16 X 16	DFT1616	3,347.00	550
18 X 6	DFT1806	3,060.00	480

Size (in.)	Item No.	List Price (\$)	Wt. (lb.)
18 X 8	DFT1808	3,812.00	495
18 X 10	DFT1810	3,700.00	510
18 X 12	DFT1812	4,070.00	535
18 X 14	DFT1814	4,496.00	630
18 X 16	DFT1816	4,714.00	650
18 X 18	DFT1818	4,302.00	665
20 X 4	DFT2004	POA	845
20 X 6	DFT2006	4,767.00	610
20 X 8	DFT2008	4,843.00	620
20 X 10	DFT2010	4,960.00	635
20 X 12	DFT2012	5,154.00	660
20 X 14	DFT2014	5,192.00	665
20 X 16	DFT2016	6,326.00	810
20 X 18	DFT2018	6,403.00	820
20 X 20	DFT2020	5,426.00	855
24 X 4	DFT2404	6,599.00	845
24 X 6	DFT2406	5,506.00	845
24 X 8	DFT2408	6,716.00	860
24 X 10	DFT2410	6,872.00	880
24 X 12	DFT2412	5,763.00	890
24 X 14	DFT2414	6,975.00	900
24 X 16	DFT2416	5,903.00	915
24 X 18	DFT2418	9,522.00	1220
24 X 20	DFT2420	9,797.00	1255
24 X 24	DFT2424	8,614.00	1330
30 X 6	DFT3006	12,169.00	1450
30 X 8	DFT3008	12,208.00	1465
30 X 10	DFT3010	12,462.00	1511
30 X 12	DFT3012	12,462.00	1490
30 X 14	DFT3014	12,462.00	1490
30 X 16	DFT3016	12,585.00	1505
30 X 18	DFT3018	12,670.00	1515
30 X 20	DFT3020	12,876.00	1540
30 X 24	DFT3024	16,932.00	2025
30 X 30	DFT3030	15,257.00	2150
36 X 6	DFT3606	16,724.00	2000
36 X 8	DFT3608	17,977.00	2150
36 X 10	DFT3610	18,019.00	2155
36 X 12	DFT3612	18,146.00	2170

Contd.....

CALL FOR BARE/BARE FITTINGS

FLANGE TEES

Contd.....

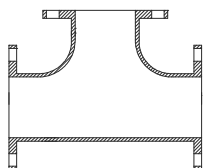

FLANGE TEES - BULL HEAD

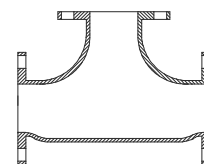

Size (in.)	Item No.	List Price (\$)	Wt. (lb.)
36 X 14	DFT3614	18,187.00	2175
36 X 16	DFT3616	18,271.00	2185
36 X 18	DFT3618	18,312.00	2190
36 X 20	DFT3620	18,478.00	2210
36 X 24	DFT3624	18,858.00	2255
36 X 30	DFT3630	25,079.00	3000
36 X 36	DFT3636	22,752.00	3160
42 X 12	DFT4212	28,224.00	3165
42 X 14	DFT4214	28,269.00	3170
42 X 16	DFT4216	28,356.00	3180
42 X 18	DFT4218	28,400.00	3185
42 X 20	DFT4220	28,583.00	3205
42 X 24	DFT4224	28,938.00	3245
42 X 30	DFT4230	36,781.00	4125
42 X 36	DFT4236	47,794.00	5360
42 X 42	DFT4242	49,756.00	5580
48 X 12	DFT4812	38,479.00	4315
48 X 14	DFT4814	38,479.00	4315
48 X 16	DFT4816	38,611.00	4330
48 X 18	DFT4818	38,611.00	4330
48 X 20	DFT4820	38,790.00	4350
48 X 24	DFT4824	39,101.00	4385
48 X 30	DFT4830	39,727.00	4455
48 X 36	DFT4836	49,534.00	5555
48 X 42	DFT4842	64,156.00	7195
48 X 48	DFT4848	65,849.00	7385
54X12	DFT5412	POA	4435
54X14	DFT5414	POA	4435
54X16	DFT5416	POA	4450
54X18	DFT5418	POA	4460
54X20	DFT5420	POA	4480
54X24	DFT5424	POA	4515
54X30	DFT5430	POA	4615
54X36	DFT5436	POA	4695
54X42	DFT5442	POA	5740
54X48	DFT5448	POA	5850
54X54	DFT5454	POA	6025

Size (in.)	Item No.	List Price (\$)	Wt. (lb.)
4 X 4 X 6	DFTBH040406	906.00	90
6 X 6 X 8	DFTBH060608	997.00	140
8 X 8 X 10	DFTBH080810	1,828.00	260
8 X 8 X 12	DFTBH080812	1,781.00	291
10 X 10 X 12	DFTBH101012	2,638.00	355
36 X 36 X 48	DFTBH363648	POA	4361

FLANGE TEES - REDUCING ON THE RUN

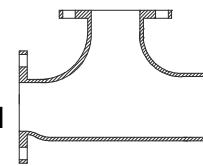

Size (in.)	Item No.	List Price (\$)	Wt. (lb.)
4 X 3 X 3	DFTROR040303	POA	55
6 X 4 X 4	DFTROR060404	637.00	103
6 X 4 X 6	DFTROR060406	637.00	108
8 X 6 X 4	DFTROR080604	884.00	146
8 X 6 X 6	DFTROR080606	1,024.00	148
8 X 6 X 8	DFTROR080608	1,128.00	145
10 X 6 X 6	DFTROR100606	2,067.00	275
10 X 6 X 10	DFTROR100610	1,981.00	305
10 X 8 X 6	DFTROR100806	2,082.00	280
10 X 8 X 8	DFTROR100808	2,196.00	302
10 X 8 X 10	DFTROR100810	2,252.00	325
12 X 6 X 6	DFTROR120606	2,571.00	340
12 X 6 X 8	DFTROR120608	2,693.00	360
12 X 8 X 6	DFTROR120806	2,638.00	355
12 X 8 X 8	DFTROR120808	2,786.00	375
12 X 8 X 12	DFTROR120812	3,122.00	420
12 X 10 X 6	DFTROR121006	2,511.00	390
12 X 10 X 8	DFTROR121008	2,972.00	400
12 X 10 X 10	DFTROR121010	3,122.00	420
12 X 10 X 12	DFTROR121012	3,269.00	440
36 X 24 X 24	DFTROR362424	POA	2255
36 X 30 X 30	DFTROR363030	POA	2575

CALL FOR BARE/BARE FITTINGS

FLANGE CROSS

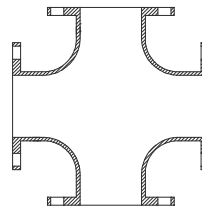

Size (in.)	Item No.	List Price (\$)	Wt. (lb.)
3 X 3	DFX0303	357.00	50
4 X 3	DFX0403	497.00	70
4 X 4	DFX0404	487.00	80
6 X 3	DFX0603	672.00	95
6 X 4	DFX0604	776.00	110
6 X 6	DFX0606	787.00	120
8 X 3	DFX0803	POA	140
8 X 4	DFX0804	1,092.00	155
8 X 6	DFX0806	1,163.00	175
8 X 8	DFX0808	1,176.00	195
10X 4	DFX1004	1,547.00	220
10X 6	DFX1006	1,689.00	240
10X 8	DFX1008	1,864.00	265
10X10	DFX1010	2,322.00	330
12X 4	DFX1204	2,179.00	310
12X 6	DFX1206	2,249.00	320
12X 8	DFX1208	2,425.00	345
12X10	DFX1210	2,917.00	415
12X12	DFX1212	2,628.00	460
14X 6	DFX1406	2,811.00	400
14X 8	DFX1408	2,986.00	425
14X10	DFX1410	3,232.00	460
14X12	DFX1412	3,550.00	505
14X14	DFX1414	3,724.00	530
16X 6	DFX1606	3,444.00	490
16X 8	DFX1608	3,654.00	520
16X10	DFX1610	3,899.00	555
16X12	DFX1612	4,251.00	605
16X14	DFX1614	POA	620
16X16	DFX1616	4,672.00	755
18X 6	DFX1806	3,666.00	505
18X 8	DFX1808	3,880.00	535
18X10	DFX1810	4,062.00	560
18X12	DFX1812	4,425.00	610
18X14	DFX1814	5,219.00	720
18X16	DFX1816	5,548.00	765
18X18	DFX1818	5,766.00	795
20X 6	DFX2006	4,960.00	635
20X 8	DFX2008	5,192.00	665
20X10	DFX2010	5,349.00	685

Size (in.)	Item No.	List Price (\$)	Wt. (lb.)
20X12	DFX2012	5,740.00	735
20X14	DFX2014	5,818.00	745
20X16	DFX2016	7,144.00	915
20X18	DFX2018	7,377.00	945
20X20	DFX2020	7,925.00	1015
24X 6	DFX2406	6,833.00	875
24X 8	DFX2408	6,987.00	895
24X10	DFX2410	7,260.00	930
24X12	DFX2412	7,494.00	960
24X14	DFX2414	7,611.00	975
24X16	DFX2416	7,886.00	1010
24X18	DFX2418	10,657.00	1365
24X20	DFX2420	11,162.00	1430
24X24	DFX2424	12,255.00	1570
30X12	DFX3012	13,088.00	1565
30X14	DFX3014	13,130.00	1570
30X16	DFX3016	13,422.00	1605
30X18	DFX3018	13,505.00	1515
30X20	DFX3020	13,966.00	1670
30X24	DFX3024	18,772.00	2245
30X30	DFX3030	20,902.00	2500
36X12	DFX3612	18,729.00	2240
36X14	DFX3614	18,729.00	2240
36X16	DFX3616	18,979.00	2270
36X18	DFX3618	19,063.00	2280
36X20	DFX3620	19,441.00	2325
36X24	DFX3624	20,108.00	2405
36X30	DFX3630	27,586.00	3300
36X36	DFX3636	30,263.00	3620
42X12	DFX4212	28,894.00	3240
42X14	DFX4214	28,894.00	3240
42X16	DFX4216	29,160.00	3270
42X18	DFX4218	29,205.00	3275
42X20	DFX4220	29,609.00	3320
42X24	DFX4224	30,276.00	4135
42X30	DFX4230	39,011.00	4375
42X36	DFX4236	51,003.00	5720
42X42	DFX4242	54,885.00	6155
48X12	DFX4812	39,148.00	4390

Contd.....

CALL FOR BARE/BARE FITTINGS

FLANGE CROSS

Contd.....

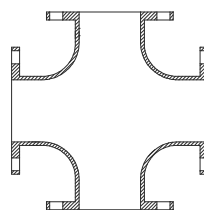

Size (in.)	Item No.	List Price (\$)	Wt. (lb.)
48X14	DFX4814	39,101.00	4385
48X16	DFX4816	39,369.00	4415
48X18	DFX4818	39,414.00	4420
48X20	DFX4820	39,770.00	4460
48X24	DFX4824	40,439.00	4535
48X30	DFX4830	41,642.00	5705
48X36	DFX4836	52,430.00	7310
48X42	DFX4842	68,032.00	7630
48X48	DFX4848	71,377.00	8005
54X12	DFX5412	POA	4575

Size (in.)	Item No.	List Price (\$)	Wt. (lb.)
54X14	DFX5414	POA	4575
54X16	DFX5416	POA	4605
54X18	DFX5418	POA	4625
54X20	DFX5420	POA	4665
54X24	DFX5424	POA	4700
54X30	DFX5430	POA	4800
54X36	DFX5436	POA	4950
54X42	DFX5442	POA	6210
54X48	DFX5448	POA	6425
54X54	DFX5454	POA	6780

FLANGE LATERAL WYES

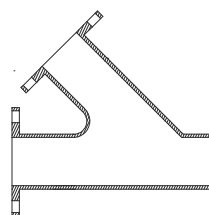

Size (in.)	Item No.	List Price (\$)	Wt. (lb.)
3 X 3	DFY0303	323.00	45
4 X 2	DFY0402	389.00	56
4 X 3	DFY0403	465.00	65
4 X 4	DFY0404	429.00	75
6 X 3	DFY0603	704.00	102
6 X 4	DFY0604	811.00	105
6 X 6	DFY0606	687.00	120
8 X 4	DFY0804	1,269.00	165
8 X 6	DFY0806	1,215.00	175
8 X 8	DFY0808	1,122.00	200
10 X 4	DFY1004	1,828.00	240
10 X 6	DFY1006	1,902.00	250
10 X 8	DFY1008	2,077.00	335
10 X 10	DFY1010	1,801.00	335
12 X 4	DFY1204	2,671.00	350
12 X 6	DFY1206	2,778.00	427
12 X 8	DFY1208	2,742.00	452

Size (in.)	Item No.	List Price (\$)	Wt. (lb.)
12 X 10	DFY1210	3,199.00	420
12 X 12	DFY1212	2,754.00	515
14 X 6	DFY1406	3,654.00	475
14 X 8	DFY1408	3,830.00	500
14 X 10	DFY1410	3,690.00	525
14 X 12	DFY1412	4,355.00	570
14 X 14	DFY1414	4,251.00	605
16 X 6	DFY1606	4,355.00	620
16 X 8	DFY1608	4,985.00	645
16 X 10	DFY1610	5,196.00	675
16 X 12	DFY1612	5,021.00	715
16 X 14	DFY1614	5,829.00	755
16 X 16	DFY1616	5,657.00	805
18 X 6	DFY1806	3,266.00	458
18 X 8	DFY1808	4,534.00	780
18 X 10	DFY1810	6,417.00	810
18 X 12	DFY1812	6,743.00	850

Contd.....

CALL FOR BARE/BARE FITTINGS

FLANGE LATERAL WYES

Contd.....

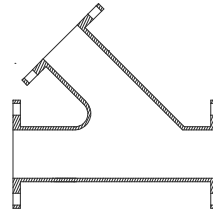

Size (in.)	Item No.	List Price (\$)	Wt. (lb.)
18 X 14	DFY1814	7,071.00	885
18 X 16	DFY1816	7,431.00	935
18 X 18	DFY1818	7,104.00	1035
20 X 8	DFY2008	5,777.00	740
20 X 10	DFY2010	6,288.00	1025
20 X 12	DFY2012	8,666.00	1065
20 X 14	DFY2014	9,487.00	1110
20 X 16	DFY2016	9,913.00	1155
20 X 18	DFY2018	9,366.00	1200
20 X 20	DFY2020	9,875.00	1265
24 X 6	DFY2406	8,276.00	1020
24 X 8	DFY2408	8,431.00	1425
24 X 10	DFY2410	11,747.00	1460
24 X 12	DFY2412	9,366.00	1550
24 X 14	DFY2414	13,657.00	1560
24 X 16	DFY2416	14,749.00	1615
24 X 18	DFY2418	14,480.00	1680
24 X 20	DFY2420	13,657.00	1750
24 X 24	DFY2424	14,868.00	1905
30 X 12	DFY3012	23,369.00	2545
30 X 14	DFY3014	23,830.00	2590
30 X 16	DFY3016	24,289.00	2645
30 X 18	DFY3018	24,748.00	2690
30 X 20	DFY3020	25,414.00	2760
30 X 24	DFY3024	26,796.00	2915
30 X 30	DFY3030	26,962.00	3225
36 X 12	DFY3612	37,538.00	4490
36 X 14	DFY3614	37,996.00	4545

Size (in.)	Item No.	List Price (\$)	Wt. (lb.)
36 X 16	DFY3616	37,246.00	4000
36 X 18	DFY3618	39,042.00	4670
36 X 20	DFY3620	38,248.00	4750
36 X 24	DFY3624	39,502.00	4920
36 X 30	DFY3630	43,470.00	5255
36 X 36	DFY3636	47,983.00	5740
42 X 12	DFY4212	51,048.00	5725
42 X 14	DFY4214	51,716.00	5800
42 X 16	DFY4216	52,162.00	5850
42 X 18	DFY4218	53,501.00	6000
42 X 20	DFY4220	54,483.00	6680
42 X 24	DFY4224	55,775.00	6850
42 X 30	DFY4230	61,126.00	7185
42 X 36	DFY4236	68,214.00	7670
42 X 42	DFY4242	81,763.00	9185
48 X 12	DFY4812	64,200.00	7200
48 X 14	DFY4814	64,869.00	7276
48 X 16	DFY4816	65,983.00	7400
48 X 18	DFY4818	67,943.00	7620
48 X 20	DFY4820	68,524.00	7685
48 X 24	DFY4824	60,992.00	8695
48 X 30	DFY4830	71,466.00	5573
48 X 36	DFY4836	79,981.00	9515
48 X 42	DFY4842	98,170.00	11030
48 X 48	DFY4848	1,07,889.00	12115
54 X 48	DFY5448	POA	9480
54 X 54	DFY5454	POA	11780
60 X 30	DFY6030	POA	9045

CALL FOR BARE/BARE FITTINGS

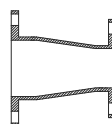
CONCENTRIC REDUCER

Size (in.)	Item No.	List Price (\$)	Wt. (lb.)
3 X 2	DFCR0302	120.00	16
3 X 2.5	DFCR0302.5	POA	21
4 X 2	DFCR0402	182.00	25
4 X 2½	DFCR04025	POA	26
4 X 3	DFCR0403	175.00	30
5 X 3	DFCR0503	POA	
5 X 4	DFCR0504	POA	
6 X 2	DFCR0602	250.00	35
6 X 3	DFCR0603	284.00	40
6 X 4	DFCR0604	272.00	45
6 X 5	DFCR0605	361.00	52
8 X 3	DFCR0803	POA	60
8 X 4	DFCR0804	407.00	65
8 X 5	DFCR0805	497.00	70
8 X 6	DFCR0806	441.00	75
10 X 4	DFCR1004	604.00	85
10 X 6	DFCR1006	577.00	90
10 X 8	DFCR1008	719.00	110
12 X 4	DFCR1204	845.00	120
12 X 6	DFCR1206	854.00	130
12 X 8	DFCR1208	953.00	145
12 X 10	DFCR1210	1,078.00	170
14 X 6	DFCR1406	1,092.00	155
14 X 8	DFCR1408	1,232.00	175
14 X 10	DFCR1410	1,353.00	190
14 X 12	DFCR1412	1,273.00	248
16 X 6	DFCR1606	1,341.00	190
16 X 8	DFCR1608	1,215.00	210
16 X 10	DFCR1610	1,365.00	235
16 X 12	DFCR1612	1,807.00	265
16 X 14	DFCR1614	1,969.00	280
18 X 8	DFCR1808	1,742.00	240
18 X 10	DFCR1810	1,925.00	265
18 X 12	DFCR1812	1,882.00	295
18 X 14	DFCR1814	2,252.00	310
18 X 16	DFCR1816	2,176.00	340
20 X 6	DFCR2006	2,345.00	306

Size (in.)	Item No.	List Price (\$)	Wt. (lb.)
20 X 8	DFCR2008	2,230.00	295
20 X 10	DFCR2010	2,425.00	310
20 X 12	DFCR2012	2,315.00	345
20 X 14	DFCR2014	2,778.00	355
20 X 16	DFCR2016	2,486.00	390
20 X 18	DFCR2018	3,204.00	410
24 X 8	DFCR2408	3,203.00	410
24 X 10	DFCR2410	3,672.00	472
24 X 12	DFCR2412	3,987.00	480
24 X 14	DFCR2414	4,094.00	490
24 X 16	DFCR2416	3,449.00	525
24 X 18	DFCR2418	4,296.00	550
24 X 20	DFCR2420	4,607.00	590
30 X 12	DFCR3012	6,443.00	825
30 X 14	DFCR3014	POA	
30 X 16	DFCR3016	6,523.00	770
30 X 18	DFCR3018	6,777.00	810
30 X 20	DFCR3020	7,279.00	870
30 X 24	DFCR3024	8,115.00	970
36 X 16	DFCR3616	9,240.00	1105
36 X 18	DFCR3618	9,701.00	1165
36 X 20	DFCR3620	10,288.00	1230
36 X 24	DFCR3624	11,251.00	1345
36 X 30	DFCR3630	13,005.00	1555
42 X 20	DFCR4220	POA	1712
42 X 24	DFCR4224	16,233.00	1820
42 X 30	DFCR4230	18,371.00	2060
42 X 36	DFCR4236	20,914.00	2550
48 X 24	DFCR4824	20,822.00	1350
48 X 30	DFCR4830	23,409.00	2625
48 X 36	DFCR4836	26,308.00	2950
48 X 42	DFCR4842	29,609.00	3320
54X30	DFCR5430	POA	1625
54X36	DFCR5436	POA	1680
54X42	DFCR5442	POA	1800
54X48	DFCR5448	POA	1695

CALL FOR BARE/BARE FITTINGS

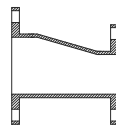
ECCENTRIC REDUCER

Size (in.)	Item No.	List Price (\$)	Wt. (lb.)
3 X 2	DFER0302	120.00	16
4 X 2	DFER0402	182.00	25
4 X 3	DFER0403	216.00	30
5 X 4	DFER0504	POA	33
6 X 2	DFER0602	POA	35
6 X 3	DFER0603	284.00	40
6 X 4	DFER0604	323.00	45
6 X 5	DFER0605	369.00	52
8 X 3	DFER0803	POA	60
8 X 4	DFER0804	465.00	65
8 X 5	DFER0805	497.00	70
8 X 6	DFER0806	532.00	75
10 X 4	DFER1004	604.00	85
10 X 6	DFER1006	637.00	90
10 X 8	DFER1008	776.00	110
12 X 4	DFER1204	845.00	120
12 X 6	DFER1206	918.00	130
12 X 8	DFER1208	1,024.00	145
12 X 10	DFER1210	1,199.00	170
14 X 6	DFER1406	1,092.00	155
14 X 8	DFER1408	1,199.00	175
14 X 10	DFER1410	1,341.00	190
14 X 12	DFER1412	1,584.00	248
16 X 6	DFER1606	1,341.00	190
16 X 8	DFER1608	1,477.00	210
16 X 10	DFER1610	1,655.00	235
16 X 12	DFER1612	1,864.00	265
16 X 14	DFER1614	1,969.00	280
18 X 8	DFER1808	1,742.00	240
18 X 10	DFER1810	1,925.00	265
18 X 12	DFER1812	2,144.00	295
18 X 14	DFER1814	2,252.00	310
18 X 16	DFER1816	2,468.00	340
20 X 8	DFER2008	2,267.00	297
20 X 10	DFER2010	2,425.00	310

Size (in.)	Item No.	List Price (\$)	Wt. (lb.)
20 X 12	DFER2012	2,698.00	345
20 X 14	DFER2014	2,778.00	355
20 X 16	DFER2016	3,047.00	390
20 X 18	DFER2018	3,203.00	410
24 X 8	DFER2408	3,596.00	465
24 X 10	DFER2410	3,672.00	473
24 X 12	DFER2412	3,750.00	480
24 X 14	DFER2414	3,828.00	490
24 X 16	DFER2416	4,103.00	525
24 X 18	DFER2418	4,296.00	550
24 X 20	DFER2420	4,607.00	590
30 X 10	DFER3010	6,326.00	760
30 X 14	DFER3014	8,115.00	825
30 X 16	DFER3016	7,822.00	770
30 X 18	DFER3018	6,818.00	810
30 X 20	DFER3020	7,279.00	870
30 X 24	DFER3024	8,115.00	970
36 X 14	DFER3614	10,789.00	1290
36 X 16	DFER3616	9,325.00	1105
36 X 18	DFER3618	9,701.00	1164
36 X 20	DFER3620	10,245.00	1230
36 X 24	DFER3624	11,206.00	1345
36 X 30	DFER3630	12,962.00	1555
42 X 20	DFER4220	POA	1712
42 X 24	DFER4224	16,233.00	1820
42 X 30	DFER4230	18,371.00	2060
42 X 36	DFER4236	20,914.00	2550
48 X 24	DFER4824	22,288.00	2562
48 X 30	DFER4830	23,409.00	2625
48 X 36	DFER4836	26,308.00	2950
48 X 42	DFER4842	29,609.00	3320
54 X 30	DFER5430	POA	1625
54 X 36	DFER5436	POA	1680
54 X 42	DFER5442	POA	1800
54 X 48	DFER5448	POA	1695

CALL FOR BARE/BARE FITTINGS

BLIND FLANGES

Size (in.)	Item No.	List Price (\$)	Wt. (lb.)
2	DBF02	POA	9
3	DBF03	70.00	9
4	DBF04	121.00	16
6	DBF06	180.00	25
8	DBF08	300.00	42
10	DBF10	448.00	63
12	DBF12	603.00	85
14	DBF14	844.00	120
16	DBF16	1,024.00	145
18	DBF18	1,415.00	195
20	DBF20	1,912.00	245
24	DBF24	2,843.00	370
30	DBF30	4,178.00	500
36	DBF36	8,015.00	960
42	DBF42	11,575.00	1300
48	DBF48	15,486.00	1740
54	DBF54	POA	2600

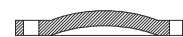
**2" TAPPED
BLIND FLANGES**

Size (in.)	Item No.	List Price (\$)	Wt. (lb.)
3	DBFT03	123.00	9
4	DBFT04	172.00	16
6	DBFT06	234.00	25
8	DBFT08	355.00	42
10	DBFT10	500.00	63
12	DBFT12	657.00	85
14	DBFT14	930.00	120
16	DBFT16	1,113.00	145
18	DBFT18	1,527.00	195
20	DBFT20	2,025.00	245
24	DBFT24	2,957.00	370
30	DBFT30	4,343.00	500
36	DBFT36	8,181.00	960
42	DBFT42	11,796.00	1300
48	DBFT48	15,712.00	1740
54	DBFT54	POA	2600

CALL FOR BARE/BARE FITTINGS



SIP Industries

Quality Manufacturers Since 1960

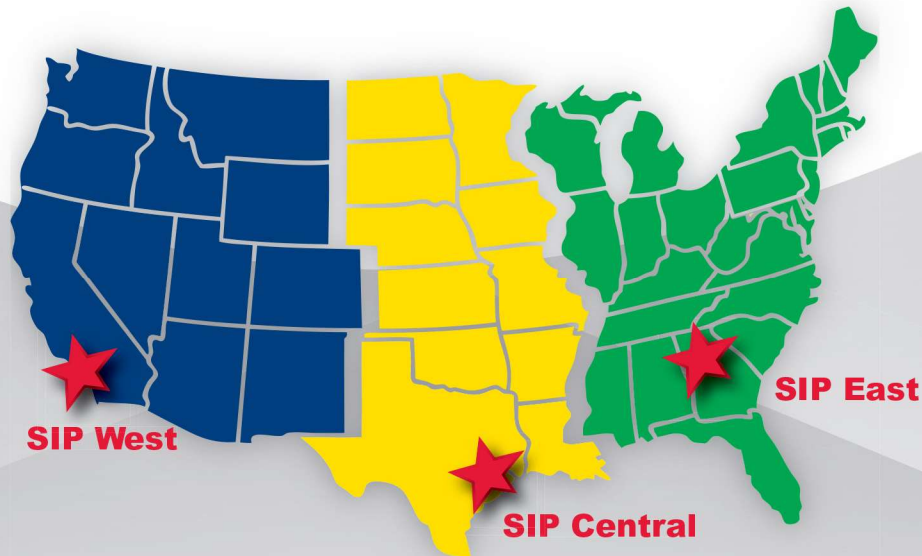

PRODUCT LINE

AWWA DI Fittings & Accessories

- C153 Compact MJ Fittings and Acc. 2" - 64"
- C110 Full Body MJ Fittings 2" - 64"
- C153 Trim Tyton® Push-On Fittings 4" - 24"
- C110 Flange Fittings 2" - 64"
- MJ x MJ Adapter for Connecting MJ Bells 3" - 24"
- Stainless Steel & Blue T-Bolts
- Made in India, China & Mexico
- Bare, Cement, Zinc, FBE & Other Linings

Joint Restraint System

- EZD Joint Restraint for DI Pipe 3" - 48"
- EZDTP Joint Restraint Tandem for DI Pipe 3" - 48"
- EZDPTP Joint Restraint for Push-On Joints DI Pipe 3" - 48"
- Ductile Iron Retainer Glands 3" - 30"
- FAR / FAH Flange Adapter for DI Pipe 3" - 48"
- EZFA Restrained Flange Adapter for DI and PVC Pipe 3" - 36"
- EZPVC Joint Restraint for PVC Pipe 3" - 36"
- ULTRA Joint Restraint for PVC Pipe 4" - 12"
- EZPVCPTP Joint Restraint for Push-On Joints PVC Pipe 14" - 36"
- PTPVC Pipe to Pipe Restraint 4" - 48"
- PTPDF Pipe to MJ Fittings Restraint 4" - 48"
- PTPFC Pipe to PVC Fittings Restraint 4" - 12"
- Made in China & USA
- EZ Shield or Shop Coating

Municipal Construction Castings

- Manhole Rings and Cover
- Frames and Grates
- Valve Boxes and Service Boxes
- Water Meter Covers and Boxes
- Cleanout and Monument Boxes
- Detectable Warning Plates
- Extension Rings
- Trench Grates and Tree Grates
- Made in India & USA

Fabrication Products for DI Pipe

- High Hub Flanges Class 150 and 250. 3" - 64"
- Threaded Bell Flanges 3" - 48"
- Anchor Flanges 3" - 60"
- Filler Flanges 4" - 30"

Other Products and Services

- All Thread Rod
- Pipe Lube and Hydraulic Cement
- Socket Clamps and Lugs
- Flange Packs
- OEM Castings



SIP CORPORATE 8876 Gulf Freeway, Suite 500, Houston, TX 77017

SIP CENTRAL 2900 Patio Drive, Houston, TX 77017

SIP EAST 600 Rayloc Drive, Atlanta, GA 30336

SIP WEST 8333 Almeria Avenue, Fontana, CA 92335

Phone: 877-921-6111 or 713-923-6111 | Fax: 713-923-6114 | www.sipindustries.com | sales@sipindustries.com