

60+
YEARS OF SERVICE

SIP INDUSTRIES
SERAMPORE
SINCE 1960

SIP Industries



Quality Manufacturers Since 1960

Utility Pipe Fittings

PRICE LIST

Effective : December 16, 2024

www.sipindustries.com

Toll Free 877-921-6111



TABLE OF CONTENTS

GENERAL TERMS & CONDITIONS.....	Page : P002 - P004
FLANGE FITTINGS ANSI/AWWA C110/A21.10.....	Page : P005 - P018
FLANGE FITTINGS ZINC COATED ANSI/AWWA C110/A21.10.....	Page : P019 - P032
FLANGE FITTINGS FUSION BONDED EPOXY ANSI/AWWA C110/A21.10.....	Page : P033 - P046
FLANGE FITTINGS CERAMIC EPOXY (P401) LINED ANSI/AWWA C110/A21.10.....	Page : P047 - P060

- All dimensions are in inches unless noted otherwise.
- All weights are approximate in pounds unless noted otherwise.
- POA = Price on availability.
- R = Available multiple size reductions.

SIP INDUSTRIES

GENERAL TERMS AND CONDITIONS OF SALE

1. Acceptance. All sales by SIP Industries (Seller) are made pursuant to these Terms and Conditions. Submission of a purchase order to Seller, and/or acceptance of goods delivered by Seller, shall be deemed an acceptance of these Terms and Conditions by Purchaser. Please note that these Terms and Conditions may be modified from time to time; the applicable Terms and Conditions are those posted on SIP's website, www.sipindustries.com, at the time that a purchase order is accepted or an agreement otherwise confirmed. Purchaser's alteration or addition to these Terms and Conditions, as same may be in effect from time to time, is expressly rejected unless accepted in writing by an authorized representative of Seller.

2. Entire Agreement. These Terms and Conditions, together with Seller's price list and Purchaser's purchase order, when accepted by Seller, shall be the entire agreement between Seller and Purchaser. Neither Seller nor Purchaser is relying on any representations, warranties or agreements except as expressly provided in these Terms and Conditions and in an accepted purchase order. To the extent of any conflict between the terms of a purchase order or any other documents submitted by Purchaser, on the one hand, and these Terms and Conditions, on the other, these Terms and Conditions shall govern.

3. Prices. Prices and descriptions of goods stated in Seller's price lists are subject to change without notice. Prices are subject to tariffs, raw material surcharges, labor disputes and shipping surcharges. To submit a purchase order, SIP Industries item numbers and part codes should be included. Seller's quotations are on globally sourced products unless otherwise noted. The ordering party is responsible to specify any required origin as required for end use. Quotations, if provided by Seller, expire sixty (60) days from the date provided unless otherwise agreed in writing.

4. Terms. Invoices are due and payable thirty (30) days from date of shipment, unless otherwise written on the invoice or confirmed in writing by Seller. A five percent (5%) late fee will be charged on all past-due accounts. If it becomes necessary to retain attorneys to collect an account, the Purchaser is liable for Seller's attorney's fees and other costs of collection.

5. FOB point of shipment. All prices are FOB point of shipment, unless otherwise agreed in writing. Seller's responsibility for goods therefore ceases and title passes to the Purchaser at the point of shipment; all claims for damages or losses in transit must be directed to the carrier with copy to Seller within ten (10) days of shipment.

6. Delivery. Seller shall have the right to select the freight carrier unless otherwise agreed. Seller has the right to substitute material with same function and design to accommodate unforeseen delays, shortages or restrictions.

7. Cancellations, Changes and Returns. All cancellations, changes and returns must be accepted in writing by an authorized representative of Seller, otherwise they will not be valid and binding on Seller. Seller will not be responsible for unauthorized returned product. It will be the responsibility of purchaser at their expense to have unauthorized product returned or disposed of. Seller shall not be obligated to accept any cancellation, change or return, but if it does so the following terms shall apply: (i) goods must be returned to Seller's facility, in the same condition in which they were accepted by Purchaser; (ii) a handling charge of thirty-five percent (35%) of the purchase price will be deducted from the credit given to Purchaser; and (iii) shipping charges, if not prepaid by Purchaser, will likewise be deducted from the credit given to Purchaser.

8. Specially Manufactured Goods. Unless otherwise agreed, specially-manufactured goods, including goods designed to the Purchaser's specifications, may not be cancelled or returned once work has begun to design or manufacture the goods unless an agreement is reached and confirmed in writing by Seller, including compensation to Seller for work thus far done with respect to the goods.

9. Delays; Force Majeure. Seller shall not be liable for any expenses, loss or damage resulting from any delay in delivery of goods or other failure of Seller's performance due to fire, floods, acts of god, strikes, labor disputes, labor shortages, riots, accidents, transportation delays or other causes beyond the reasonable control of Seller.

10. Disclaimer regarding weights. All stated weights are approximate and are given for inventory and shipping purposes only.

11. Taxes. Seller's prices do not include sales, excise or other taxes. Purchaser shall pay all such taxes. If Purchaser claims a tax exemption, Purchaser shall provide Seller with the necessary tax-exemption numbers and certificates. If Purchaser aims a tax exemption, Purchaser shall provide Seller with the necessary tax-exemption numbers and certificates. If Seller accepts an exemption but is later required by the taxing authority to pay taxes, Purchaser shall reimburse to Seller the amount of such taxes.

12. Limited Warranty. For a period of one calendar year from the date of shipment, Seller warrants that goods sold and delivered by Seller to Purchaser will conform to the number and type of goods described in the accepted purchase order and that such goods will be free from defects in material and workmanship.

THIS LIMITED WARRANTY IS SELLER'S SOLE AND EXCLUSIVE WARRANTY. SELLER MAKES NO OTHER WARRANTY OF ANY KIND, EXPRESS OR IMPLIED. SELLER DOES NOT WARRANT THAT THE GOODS ARE FIT FOR ANY PARTICULAR PURPOSE. SELLER DOES NOT WARRANT THAT THE GOODS ARE MERCHANTABILITY.

13. Product Disclaimers. All tooling required to manufacture products are the property of Seller even if tooling costs are incurred by Purchaser. Seller has the right to change product design, engineering, materials, tooling and processes that do not affect the intended use and application of the product. Seller will notify Purchaser if changes are substantial and may affect the application or appearance of the product. Furthermore, references to Buyer's specifications and similar requirements are only to describe the goods and do not give rise to any representation, warranty or other sales term.

Seller manufactures to industry standards and makes every effort to address applications of its products. Please see current technical advisory at Seller's web site, sipindustries.com, for up to date product support and recommendations. All product dimension, designs, technology, tooling, process, software, innovations, and drawings are considered intellectual property and are owned and confidential to Seller. Purchaser has no rights or privileges to SIP industries intellectual property including product applications without Seller's express written consent.

14. Prompt notice required for Limited Warranty claims. Buyer is responsible for promptly inspecting goods on delivery and notifying Seller, within sixty (60) days of delivery to Buyer, of any nonconformity or defect that would be discovered on a reasonable and customary inspection. Provided that such notice is given and that the warranty claim is made within one year, Seller will provide a replacement or price adjustment, in Seller's discretion, not to exceed the net sales price of the defective product. However, this warranty shall be of no force or effect absent such timely notice. Seller shall not in any event be responsible for labor, removal or installation charges incurred in connection with the replacement of defective goods.

15. Conditions to Limited Warranty. Purchaser shall notify Seller immediately upon discovery of a defect so that Seller may inspect the product in its installed condition. Seller shall not be responsible for defects or failures in goods of which it is not so notified; nor shall Seller be responsible for goods manufactured or sold by other parties or losses or impairments caused by such goods; nor shall Seller be responsible for defects or failure of goods due to improper installation, improper usage, normal or abnormal wear and tear, erosion or corrosion, improper storage, use or maintenance, vandalism, vehicular or other accidents, or storms or other forces beyond the control of the parties. Seller also shall not be responsible for goods that have been damaged by misuse, negligence or accident or that have been altered or repaired by any party other than Seller.

16. Limitation on Liability. In the event any remedy hereunder fails of its essential purpose and monetary damages may be imposed, Seller's liability, whether founded in contract or tort (including negligence), arising out of or resulting from (i) the Purchase Order and resulting contract or the performance or breach thereof, or (ii) the design, manufacture, delivery, sale, repair, replacement or use of the goods, shall not exceed the cost of the goods at issue in the claim. NOTWITHSTANDING ANYTHING CONTAINED HEREIN TO THE CONTRARY, SELLER SHALL NOT BE LIABLE TO PURCHASER OR ANY OTHER PERSON FOR CONSEQUENTIAL, INCIDENTAL, SPECIAL, EXEMPLARY, PUNITIVE OR OTHER INDIRECT DAMAGES, INCLUDING, WITHOUT LIMITATION, LOSS OF PROFITS, RECALL-RELATED EXPENSES, AND LOSS OF USE OF THE GOODS.

17. Purchaser specifications. If Seller has designed the goods using information provided by Purchaser, Seller shall not be responsible for design errors resulting from inaccurate or incomplete information supplied by Purchaser. If

Purchaser has provided specifications or a model or sample from which a good is designed and manufactured, Seller shall not be responsible for any defect, error or inadequacy provided that the good is designed or manufactured in compliance with Purchaser's specifications, model or sample.

18. Solvency and Security Interest. By submitting a Purchase Order, Buyer represents to Seller that Buyer is solvent and capable of timely fulfilling its payment and other obligations to Seller. Until the goods and any other indebtedness of Buyer have been paid in full, Buyer, its agents any successors: (i) will hold the goods subject to a security interest in favor of Seller allowing for the right or re-possession by Seller to the extent permitted by applicable law, (ii) will not alter, remove, destroy, or damage any identifying mark on the goods or their packaging, and (iii) will keep the goods separate from any other products.

19. Governing law; venue. All sales shall be governed by the law of the state of Texas. In the event that a lawsuit is filed between the parties on any claim arising out of or in connection with such sales, Seller and Purchaser agree that exclusive venue and jurisdiction shall be in the state or federal courts of Harris County, Texas.

20. Attorney's fees and costs. In the event of litigation between the parties with respect to the sale of goods, the prevailing party shall be entitled to recover its reasonable attorney's fees and costs, including expert witness fees.

Utility Pipe Fittings & Accessories

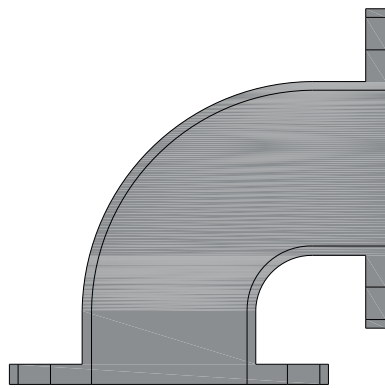

ANSI/AWWA C110/A21.10
FLANGE FITTINGS

PRICE LIST

Effective December 16, 2024



FLANGE BENDS
90° (1/4)

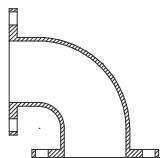

Size (in.)	Item No.	List Price (\$)	Wt. (lb.)
2	DFB9002	143.00	14
3	DFB9003	165.00	25
4	DFB9004	255.00	45
5	DFB9005	POA	62
6	DFB9006	394.00	65
8	DFB9008	644.00	105
10	DFB9010	1,022.00	165
12	DFB9012	1,328.00	235
14	DFB9014	1,747.00	290
16	DFB9016	2,153.00	370
18	DFB9018	3,002.00	450
20	DFB9020	3,672.00	580
24	DFB9024	6,050.00	900
30	DFB9030	10,659.00	1430
36	DFB9036	15,620.00	2135
42	DFB9042	27,244.00	3055
48	DFB9048	36,516.00	4095
54	DFB9054	POA	3740
64	DFB9064	POA	6752

FLANGE BENDS
45° (1/8)

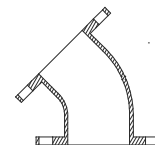

Size (in.)	Item No.	List Price (\$)	Wt. (lb.)
2	DFB4502	153.00	12
3	DFB4503	128.00	20
4	DFB4504	228.00	40
5	DFB4505	POA	52
6	DFB4506	350.00	55
8	DFB4508	532.00	90
10	DFB4510	859.00	130
12	DFB4512	1,122.00	195
14	DFB4514	1,328.00	220
16	DFB4516	1,689.00	280
18	DFB4518	2,358.00	325
20	DFB4520	3,085.00	430
24	DFB4524	4,284.00	630
30	DFB4530	9,366.00	1120
36	DFB4536	14,677.00	1755
42	DFB4542	23,183.00	2600
48	DFB4548	31,925.00	3580
54	DFB4554	POA	2735

FLANGE BENDS
22½° (1/16)

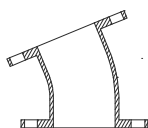

Size (in.)	Item No.	List Price (\$)	Wt. (lb.)
2	DFB2202	207.00	12
3	DFB2203	145.00	20
4	DFB2204	227.00	40
6	DFB2206	334.00	55
8	DFB2208	520.00	90
10	DFB2210	822.00	135
12	DFB2212	1,204.00	205
14	DFB2214	1,584.00	225
16	DFB2216	1,746.00	285
18	DFB2218	2,431.00	335
20	DFB2220	3,399.00	435
24	DFB2224	4,997.00	640
30	DFB2230	9,492.00	1135
36	DFB2236	14,970.00	1790
42	DFB2242	23,766.00	2665
48	DFB2248	32,684.00	3665
54	DFB2254	POA	2260

FLANGE BENDS
11¼° (1/32)

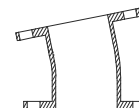

Size (in.)	Item No.	List Price (\$)	Wt. (lb.)
2	DFB1102	207.00	12
3	DFB1103	145.00	20
4	DFB1104	272.00	40
6	DFB1106	421.00	55
8	DFB1108	555.00	90
10	DFB1110	953.00	135
12	DFB1112	1,447.00	205
14	DFB1114	1,647.00	225
16	DFB1116	2,005.00	285
18	DFB1118	2,431.00	335
20	DFB1120	3,399.00	435
24	DFB1124	5,251.00	645
30	DFB1130	9,619.00	1150
36	DFB1136	15,094.00	1805
42	DFB1142	23,900.00	2680
48	DFB1148	32,950.00	3695
54	DFB1154	POA	2100

CALL FOR BARE/BARE FITTINGS

90° LONG RADIUS BENDS

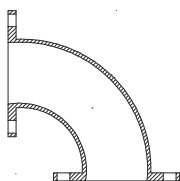

Size (in.)	Item No.	List Price (\$)	Wt. (lb.)
3	DFBLR9003	216.00	30
4	DFBLR9004	357.00	30
5	DFBLR9005	POA	76
6	DFBLR9006	619.00	80
8	DFBLR9008	1,024.00	140
10	DFBLR9010	1,514.00	215
12	DFBLR9012	2,284.00	325
14	DFBLR9014	2,708.00	580
16	DFBLR9016	3,550.00	740
18	DFBLR9018	4,570.00	840
20	DFBLR9020	6,326.00	928
24	DFBLR9024	9,678.00	1640
30	DFBLR9030	17,601.00	2105
36	DFBLR9036	27,465.00	3285
42	DFBLR9042	43,383.00	4865
48	DFBLR9048	60,547.00	7800
54	DFBLR9054	POA	6205

90° FLANGE X FLARE BENDS

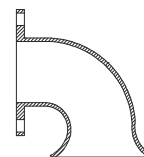

Size (in.)	Item No.	List Price (\$)	Wt. (lb.)
3	DFF9003	182.00	25
4	DFF9004	323.00	40
6	DFF9006	497.00	70
8	DFF9008	845.00	110
10	DFF9010	1,376.00	175
12	DFF9012	1,725.00	245
14	DFF9014	2,391.00	340
16	DFF9016	3,232.00	460
18	DFF9018	4,062.00	560
20	DFF9020	5,465.00	700
24	DFF9024	7,768.00	1100
30	DFF9030	16,472.00	1840
36	DFF9036	22,824.00	2700
42	DFF9042	28,535.00	3250
48	DFF9048	46,680.00	4215
54	DFF9054	POA	3965

STRAIGHT FLANGE X FLARE

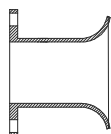

Size (in.)	Item No.	List Price (\$)	Wt. (lb.)
3	DFP03	145.00	20
4	DFP04	216.00	30
6	DFP06	284.00	40
8	DFP08	497.00	70
10	DFP10	672.00	95
12	DFP12	1,092.00	115
14	DFP14	1,163.00	190
16	DFP16	1,689.00	330
18	DFP18	1,998.00	355
20	DFP20	2,783.00	460
24	DFP24	3,750.00	635
30	DFP30	9,201.00	1025
36	DFP36	12,208.00	1460
42	DFP42	15,609.00	1900
48	DFP48	21,179.00	2350
54	DFP54	POA	2035

LONG RADIUS 90° FLANGE X FLARE BENDS

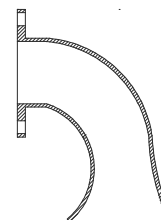

Size (in.)	Item No.	List Price (\$)	Wt. (lb.)
3	DFFLR9003	250.00	30
4	DFFLR9004	357.00	50
6	DFFLR9006	637.00	90
8	DFFLR9008	1,092.00	115
10	DFFLR9010	1,761.00	250
12	DFFLR9012	2,637.00	375
14	DFFLR9014	3,513.00	500
16	DFFLR9016	5,021.00	715
18	DFFLR9018	5,798.00	800
20	DFFLR9020	8,896.00	1140
24	DFFLR9024	10,422.00	1335
30	DFFLR9030	18,312.00	2190
36	DFFLR9036	28,971.00	3465
42	DFFLR9042	45,922.00	5150
48	DFFLR9048	59,963.00	6725

CALL FOR BARE/BARE FITTINGS

90° REDUCING BENDS

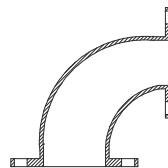

Size (in.)	Item No.	List Price (\$)	Wt. (lb.)
4 X 3	DFBR0403	210.00	35
6 X 3	DFBR0603	396.00	45
6 X 4	DFBR0604	389.00	55
6 X 5	DFBR0605	396.00	65
8 X 4	DFBR0804	532.00	80
8 X 5	DFBR0805	856.00	100
8 X 6	DFBR0806	604.00	90
10X 4	DFBR1004	918.00	105
10X 6	DFBR1006	953.00	125
10X 8	DFBR1008	1,058.00	150
12X 4	DFBR1204	988.00	145
12X 6	DFBR1206	1,128.00	165
12X 8	DFBR1208	1,341.00	190
12X10	DFBR1210	1,406.00	220
14X 6	DFBR1406	1,341.00	144
14X 8	DFBR1408	1,514.00	200
14X10	DFBR1410	1,689.00	260
14X12	DFBR1412	1,902.00	270
16X 6	DFBR1606	1,547.00	220
16X 8	DFBR1608	1,689.00	240
16X10	DFBR1610	1,969.00	344
16X12	DFBR1612	2,179.00	373
16X14	DFBR1614	2,355.00	330
18X 6	DFBR1806	1,888.00	260
18X 8	DFBR1808	2,358.00	280
18X10	DFBR1810	2,397.00	320
18X12	DFBR1812	2,543.00	465
18X14	DFBR1814	2,795.00	370
18X16	DFBR1816	3,047.00	410
20X 6	DFBR2006	2,502.00	320
20X 8	DFBR2008	2,698.00	345
20X10	DFBR2010	3,477.00	385
20X12	DFBR2012	3,611.00	415
20X14	DFBR2014	4,047.00	518
20X16	DFBR2016	3,868.00	533
20X18	DFBR2018	4,103.00	515
24X 6	DFBR2406	3,750.00	480
24X 8	DFBR2408	3,946.00	505
24X10	DFBR2410	4,256.00	545
24X12	DFBR2412	4,491.00	575
24X14	DFBR2414	4,960.00	595
24X16	DFBR2416	5,349.00	635
24X18	DFBR2418	5,427.00	675

Size (in.)	Item No.	List Price (\$)	Wt. (lb.)
24X20	DFBR2420	5,777.00	740
30X12	DFBR3012	7,024.00	840
30X14	DFBR3014	8,563.00	860
30X16	DFBR3016	7,527.00	900
30X18	DFBR3018	11,740.00	940
30X20	DFBR3020	12,406.00	1005
30X24	DFBR3024	10,080.00	1165
36X12	DFBR3612	9,994.00	1195
36X14	DFBR3614	13,293.00	1215
36X16	DFBR3616	10,496.00	1255
36X18	DFBR3618	14,044.00	1295
36X20	DFBR3620	14,515.00	1315
36X24	DFBR3624	13,256.00	1520
36X30	DFBR3630	15,385.00	1785
42X12	DFBR4212	POA	1655
42X14	DFBR4214	18,486.00	1675
42X16	DFBR4216	15,297.00	1715
42X18	DFBR4218	21,045.00	1755
42X20	DFBR4220	20,566.00	1820
42X24	DFBR4224	17,660.00	1980
42X30	DFBR4230	20,914.00	2245
42X36	DFBR4236	30,231.00	2600
48X12	DFBR4812	19,397.00	2175
48X14	DFBR4814	23,874.00	2195
48X16	DFBR4816	19,931.00	2235
48X18	DFBR4818	29,480.00	2275
48X20	DFBR4820	32,045.00	2340
48X24	DFBR4824	28,894.00	2500
48X30	DFBR4830	31,391.00	2765
48X36	DFBR4836	32,263.00	3115
48X42	DFBR4842	41,775.00	3580
54X12	DFBR5412	POA	1990
54X14	DFBR5414	POA	2015
54X16	DFBR5416	POA	2055
54X18	DFBR5418	POA	2095
54X20	DFBR5420	POA	2160
54X24	DFBR5424	POA	2320
54X30	DFBR5430	POA	2585
54X36	DFBR5436	POA	2940
54X42	DFBR5442	POA	3395
54X48	DFBR5448	POA	3565

CALL FOR BARE/BARE FITTINGS

90° BASE BENDS

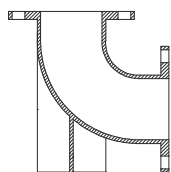

Size (in.)	Item No.	List Price (\$)	Wt. (lb.)
3	DFBB9003	250.00	35
4	DFBB9004	389.00	55
6	DFBB9006	551.00	85
8	DFBB9008	1,070.00	145
10	DFBB9010	1,477.00	210
12	DFBB9012	2,101.00	300
14	DFBB9014	2,532.00	320
16	DFBB9016	3,128.00	445
18	DFBB9018	4,100.00	565
20	DFBB9020	5,465.00	700
24	DFBB9024	8,039.00	1030
30	DFBB9030	13,587.00	1625
36	DFBB9036	19,942.00	2385
42	DFBB9042	38,432.00	3465
48	DFBB9048	41,109.00	4610
54	DFBB9054	POA	4415

90° LONG RADIUS BASE BENDS

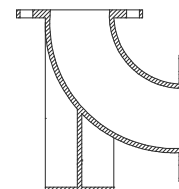

Size (in.)	Item No.	List Price (\$)	Wt. (lb.)
3	DFBBLR9003	272.00	40
4	DFBBLR9004	425.00	60
6	DFBBLR9006	704.00	100
8	DFBBLR9008	1,269.00	180
10	DFBBLR9010	1,828.00	260
12	DFBBLR9012	2,931.00	390
14	DFBBLR9014	2,931.00	650
16	DFBBLR9016	5,196.00	815
18	DFBBLR9018	5,798.00	955
20	DFBBLR9020	7,690.00	1200
24	DFBBLR9024	11,162.00	1770
30	DFBBLR9030	20,064.00	2295
36	DFBBLR9036	30,765.00	3535
42	DFBBLR9042	49,177.00	5275
48	DFBBLR9048	68,076.00	7305
54	DFBBLR9054	POA	6880

BASE TEES

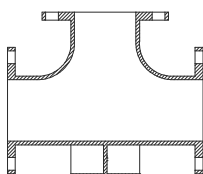

Size (in.)	Item No.	List Price (\$)	Wt. (lb.)
3	DFTB0303	323.00	45
4	DFTB0404	532.00	75
6	DFTB0606	776.00	110
8	DFTB0808	1,306.00	185
10	DFTB1010	2,110.00	300
12	DFTB1212	3,021.00	430
14	DFTB1414	3,409.00	500
16	DFTB1616	4,216.00	600
18	DFTB1818	5,365.00	740
20	DFTB2020	7,260.00	930
24	DFTB2424	11,006.00	1410
30	DFTB3030	18,979.00	2270
36	DFTB3636	27,755.00	3320
42	DFTB4242	52,162.00	5850
48	DFTB4848	68,838.00	7720
54	DFTB5454	POA	6465

CALL FOR BARE/BARE FITTINGS

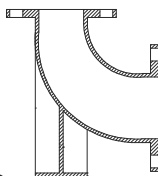
90° REDUCING BASE BENDS
 (WITH BASE UNDER SMALL END)

R - Available multiple size reductions.

Size (in.)	Item No.	List Price (\$)	Wt. (lb.)
4 X 3	DFBBSDR0403	POA	45
6 X 4	DFBBSDR0604	POA	75
8 X 4	DFBBSDR0804	POA	120
8 X 6	DFBBSDR0806	POA	130
10X 6	DFBBSDR1006	POA	170
10X 8	DFBBSDR1008	POA	195
12X 6	DFBBSDR1206	POA	230
12X 8	DFBBSDR1208	POA	255
12X10	DFBBSDR1210	POA	285
14X R	DFBBSDR14	POA	
16X R	DFBBSDR16	POA	
18X R	DFBBSDR18	POA	
20X R	DFBBSDR20	POA	
24X R	DFBBSDR24	POA	
30X R	DFBBSDR30	POA	
36X R	DFBBSDR36	POA	
42X R	DFBBSDR42	POA	
48X R	DFBBSDR48	POA	
54X R	DFBBSDR54	POA	

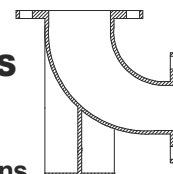
90° REDUCING BASE BENDS
 (WITH BASE UNDER LARGE END)

R - Available multiple size reductions.

Size (in.)	Item No.	List Price (\$)	Wt. (lb.)
4 X 3	DFBBLDR0403	POA	45
6 X 4	DFBBLDR0604	POA	75
8 X 4	DFBBLDR0804	POA	120
8 X 6	DFBBLDR0806	POA	130
10X 6	DFBBLDR1006	POA	170
10X 8	DFBBLDR1008	POA	195
12X 6	DFBBLDR1206	POA	230
12X 8	DFBBLDR1208	POA	255
12X10	DFBBLDR1210	POA	285
14X R	DFBBLDR14	POA	
16X R	DFBBLDR16	POA	
18X R	DFBBLDR18	POA	
20X R	DFBBLDR20	POA	
24X R	DFBBLDR24	POA	
30X R	DFBBLDR30	POA	
36X R	DFBBLDR36	POA	
42X R	DFBBLDR42	POA	
48X R	DFBBLDR48	POA	
54X R	DFBBLDR54	POA	

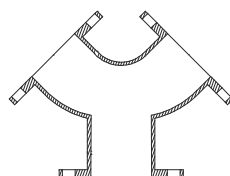
TRUE WYES

Size (in.)	Item No.	List Price (\$)	Wt. (lb.)
4 X 4 X 4	DFYT040404	357.00	50
6 X 4 X 4	DFYT060404	POA	75
6 X 6 X 6	DFYT060606	566.00	80
8 X 8 X 4	DFYT080804	604.00	87
8 X 6 X 6	DFYT080606	POA	120
8 X 8 X 8	DFYT080808	988.00	125
10 X 10 X 6	DFYT101006	988.00	142
10 X 8 X 8	DFYT100808	1,092.00	155
10 X 10 X 10	DFYT101010	1,306.00	185
12 X 12 X 6	DFYT121206	1,128.00	173
12 X 12 X 8	DFYT121208	1,477.00	225

Size (in.)	Item No.	List Price (\$)	Wt. (lb.)
12 X 12 X 10	DFYT121210	1,689.00	300
12 X 12 X 12	DFYT121212	2,110.00	300
14 X 14 X 14	DFYT141414	2,917.00	415
16 X 16 X 16	DFYT161616	4,076.00	580
18 X 18 X 18	DFYT181818	4,932.00	680
20 X 20 X 20	DFYT202020	7,494.00	960
24 X 24 X 24	DFYT242424	10,693.00	1370
30 X 30 X 30	DFYT303030	POA	80
36 X 36 X 36	DFYT363636	POA	120
42 X 42 X 42	DFYT424242	POA	125
48 X 48 X 48	DFYT484848	POA	120

CALL FOR BARE/BARE FITTINGS

FLANGE TEES

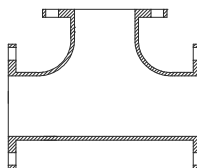

Size (in.)	Item No.	List Price (\$)	Wt. (lb.)
2 X 2	DFT0202	179.00	20
2½ X 2½	DFT02.5	POA	30
3 X 2	DFT0302	250.00	35
3 X 3	DFT0303	235.00	40
4 X 2	DFT0402	357.00	50
4 X 3	DFT0403	425.00	60
4 X 4	DFT0404	465.00	65
5 X 5	DFT0505	POA	80
6 X 2	DFT0602	604.00	156
6 X 3	DFT0603	604.00	85
6 X 4	DFT0604	637.00	90
6 X 6	DFT0606	577.00	95
8 X 3	DFT0803	974.00	130
8 X 4	DFT0804	893.00	140
8 X 6	DFT0806	829.00	145
8 X 8	DFT0808	960.00	155
10 X 4	DFT1004	1,281.00	205
10 X 6	DFT1006	1,197.00	215
10 X 8	DFT1008	1,254.00	225
10 X 10	DFT1010	1,459.00	270
12 X 4	DFT1204	1,739.00	290
12 X 6	DFT1206	1,672.00	295
12 X 8	DFT1208	1,761.00	310
12 X 10	DFT1210	2,099.00	360
12 X 12	DFT1212	2,117.00	385
14 X 4	DFT1404	POA	370
14 X 6	DFT1406	2,637.00	375
14 X 8	DFT1408	2,742.00	390
14 X 10	DFT1410	2,811.00	400
14 X 12	DFT1412	2,986.00	425
14 X 14	DFT1414	3,057.00	435
16 X 4	DFT1604	4,613.00	460
16 X 6	DFT1606	3,035.00	465
16 X 8	DFT1608	2,935.00	475
16 X 10	DFT1610	3,447.00	495
16 X 12	DFT1612	3,281.00	520
16 X 14	DFT1614	3,724.00	530
16 X 16	DFT1616	3,347.00	550
18 X 6	DFT1806	3,060.00	480

Size (in.)	Item No.	List Price (\$)	Wt. (lb.)
18 X 8	DFT1808	3,812.00	495
18 X 10	DFT1810	3,700.00	510
18 X 12	DFT1812	4,070.00	535
18 X 14	DFT1814	4,496.00	630
18 X 16	DFT1816	4,714.00	650
18 X 18	DFT1818	4,302.00	665
20 X 4	DFT2004	POA	845
20 X 6	DFT2006	4,767.00	610
20 X 8	DFT2008	4,843.00	620
20 X 10	DFT2010	4,960.00	635
20 X 12	DFT2012	5,154.00	660
20 X 14	DFT2014	5,192.00	665
20 X 16	DFT2016	6,326.00	810
20 X 18	DFT2018	6,403.00	820
20 X 20	DFT2020	5,426.00	855
24 X 4	DFT2404	6,599.00	845
24 X 6	DFT2406	5,506.00	845
24 X 8	DFT2408	6,716.00	860
24 X 10	DFT2410	6,872.00	880
24 X 12	DFT2412	5,763.00	890
24 X 14	DFT2414	6,975.00	900
24 X 16	DFT2416	5,903.00	915
24 X 18	DFT2418	9,522.00	1220
24 X 20	DFT2420	9,797.00	1255
24 X 24	DFT2424	8,614.00	1330
30 X 6	DFT3006	12,169.00	1450
30 X 8	DFT3008	12,208.00	1465
30 X 10	DFT3010	12,462.00	1511
30 X 12	DFT3012	12,462.00	1490
30 X 14	DFT3014	12,462.00	1490
30 X 16	DFT3016	12,585.00	1505
30 X 18	DFT3018	12,670.00	1515
30 X 20	DFT3020	12,876.00	1540
30 X 24	DFT3024	16,932.00	2025
30 X 30	DFT3030	15,257.00	2150
36 X 6	DFT3606	16,724.00	2000
36 X 8	DFT3608	17,977.00	2150
36 X 10	DFT3610	18,019.00	2155
36 X 12	DFT3612	18,146.00	2170

Contd.....

CALL FOR BARE/BARE FITTINGS

FLANGE TEES

Contd.....

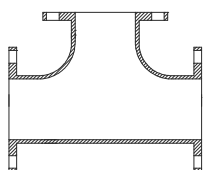

Size (in.)	Item No.	List Price (\$)	Wt. (lb.)
36 X 14	DFT3614	18,187.00	2175
36 X 16	DFT3616	18,271.00	2185
36 X 18	DFT3618	18,312.00	2190
36 X 20	DFT3620	18,478.00	2210
36 X 24	DFT3624	18,858.00	2255
36 X 30	DFT3630	25,079.00	3000
36 X 36	DFT3636	22,752.00	3160
42 X 12	DFT4212	28,224.00	3165
42 X 14	DFT4214	28,269.00	3170
42 X 16	DFT4216	28,356.00	3180
42 X 18	DFT4218	28,400.00	3185
42 X 20	DFT4220	28,583.00	3205
42 X 24	DFT4224	28,938.00	3245
42 X 30	DFT4230	36,781.00	4125
42 X 36	DFT4236	47,794.00	5360
42 X 42	DFT4242	49,756.00	5580
48 X 12	DFT4812	38,479.00	4315
48 X 14	DFT4814	38,479.00	4315
48 X 16	DFT4816	38,611.00	4330
48 X 18	DFT4818	38,611.00	4330
48 X 20	DFT4820	38,790.00	4350
48 X 24	DFT4824	39,101.00	4385
48 X 30	DFT4830	39,727.00	4455
48 X 36	DFT4836	49,534.00	5555
48 X 42	DFT4842	64,156.00	7195
48 X 48	DFT4848	65,849.00	7385
54X12	DFT5412	POA	4435
54X14	DFT5414	POA	4435
54X16	DFT5416	POA	4450
54X18	DFT5418	POA	4460
54X20	DFT5420	POA	4480
54X24	DFT5424	POA	4515
54X30	DFT5430	POA	4615
54X36	DFT5436	POA	4695
54X42	DFT5442	POA	5740
54X48	DFT5448	POA	5850
54X54	DFT5454	POA	6025

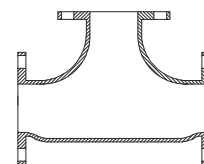
FLANGE TEES - BULL HEAD

Size (in.)	Item No.	List Price (\$)	Wt. (lb.)
4 X 4 X 6	DFTBH040406	906.00	90
6 X 6 X 8	DFTBH060608	997.00	140
8 X 8 X 10	DFTBH080810	1,828.00	260
8 X 8 X 12	DFTBH080812	1,781.00	291
10 X 10 X 12	DFTBH101012	2,638.00	355
36 X 36 X 48	DFTBH363648	POA	4361

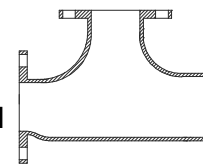
FLANGE TEES - REDUCING ON THE RUN

Size (in.)	Item No.	List Price (\$)	Wt. (lb.)
4 X 3 X 3	DFTROR040303	POA	55
6 X 4 X 4	DFTROR060404	637.00	103
6 X 4 X 6	DFTROR060406	637.00	108
8 X 6 X 4	DFTROR080604	884.00	146
8 X 6 X 6	DFTROR080606	1,024.00	148
8 X 6 X 8	DFTROR080608	1,128.00	145
10 X 6 X 6	DFTROR100606	2,067.00	275
10 X 6 X 10	DFTROR100610	1,981.00	305
10 X 8 X 6	DFTROR100806	2,082.00	280
10 X 8 X 8	DFTROR100808	2,196.00	302
10 X 8 X 10	DFTROR100810	2,252.00	325
12 X 6 X 6	DFTROR120606	2,571.00	340
12 X 6 X 8	DFTROR120608	2,693.00	360
12 X 8 X 6	DFTROR120806	2,638.00	355
12 X 8 X 8	DFTROR120808	2,786.00	375
12 X 8 X 12	DFTROR120812	3,122.00	420
12 X 10 X 6	DFTROR121006	2,511.00	390
12 X 10 X 8	DFTROR121008	2,972.00	400
12 X 10 X 10	DFTROR121010	3,122.00	420
12 X 10 X 12	DFTROR121012	3,269.00	440
36 X 24 X 24	DFTROR362424	POA	2255
36 X 30 X 30	DFTROR363030	POA	2575

CALL FOR BARE/BARE FITTINGS

FLANGE CROSS

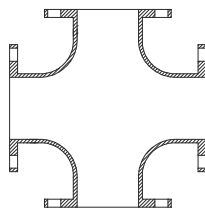

Size (in.)	Item No.	List Price (\$)	Wt. (lb.)
3 X 3	DFX0303	357.00	50
4 X 3	DFX0403	497.00	70
4 X 4	DFX0404	487.00	80
6 X 3	DFX0603	672.00	95
6 X 4	DFX0604	776.00	110
6 X 6	DFX0606	787.00	120
8 X 3	DFX0803	POA	140
8 X 4	DFX0804	1,092.00	155
8 X 6	DFX0806	1,163.00	175
8 X 8	DFX0808	1,176.00	195
10X 4	DFX1004	1,547.00	220
10X 6	DFX1006	1,689.00	240
10X 8	DFX1008	1,864.00	265
10X10	DFX1010	2,322.00	330
12X 4	DFX1204	2,179.00	310
12X 6	DFX1206	2,249.00	320
12X 8	DFX1208	2,425.00	345
12X10	DFX1210	2,917.00	415
12X12	DFX1212	2,628.00	460
14X 6	DFX1406	2,811.00	400
14X 8	DFX1408	2,986.00	425
14X10	DFX1410	3,232.00	460
14X12	DFX1412	3,550.00	505
14X14	DFX1414	3,724.00	530
16X 6	DFX1606	3,444.00	490
16X 8	DFX1608	3,654.00	520
16X10	DFX1610	3,899.00	555
16X12	DFX1612	4,251.00	605
16X14	DFX1614	POA	620
16X16	DFX1616	4,672.00	755
18X 6	DFX1806	3,666.00	505
18X 8	DFX1808	3,880.00	535
18X10	DFX1810	4,062.00	560
18X12	DFX1812	4,425.00	610
18X14	DFX1814	5,219.00	720
18X16	DFX1816	5,548.00	765
18X18	DFX1818	5,766.00	795
20X 6	DFX2006	4,960.00	635
20X 8	DFX2008	5,192.00	665
20X10	DFX2010	5,349.00	685

Size (in.)	Item No.	List Price (\$)	Wt. (lb.)
20X12	DFX2012	5,740.00	735
20X14	DFX2014	5,818.00	745
20X16	DFX2016	7,144.00	915
20X18	DFX2018	7,377.00	945
20X20	DFX2020	7,925.00	1015
24X 6	DFX2406	6,833.00	875
24X 8	DFX2408	6,987.00	895
24X10	DFX2410	7,260.00	930
24X12	DFX2412	7,494.00	960
24X14	DFX2414	7,611.00	975
24X16	DFX2416	7,886.00	1010
24X18	DFX2418	10,657.00	1365
24X20	DFX2420	11,162.00	1430
24X24	DFX2424	12,255.00	1570
30X12	DFX3012	13,088.00	1565
30X14	DFX3014	13,130.00	1570
30X16	DFX3016	13,422.00	1605
30X18	DFX3018	13,505.00	1515
30X20	DFX3020	13,966.00	1670
30X24	DFX3024	18,772.00	2245
30X30	DFX3030	20,902.00	2500
36X12	DFX3612	18,729.00	2240
36X14	DFX3614	18,729.00	2240
36X16	DFX3616	18,979.00	2270
36X18	DFX3618	19,063.00	2280
36X20	DFX3620	19,441.00	2325
36X24	DFX3624	20,108.00	2405
36X30	DFX3630	27,586.00	3300
36X36	DFX3636	30,263.00	3620
42X12	DFX4212	28,894.00	3240
42X14	DFX4214	28,894.00	3240
42X16	DFX4216	29,160.00	3270
42X18	DFX4218	29,205.00	3275
42X20	DFX4220	29,609.00	3320
42X24	DFX4224	30,276.00	4135
42X30	DFX4230	39,011.00	4375
42X36	DFX4236	51,003.00	5720
42X42	DFX4242	54,885.00	6155
48X12	DFX4812	39,148.00	4390

Contd.....

CALL FOR BARE/BARE FITTINGS

FLANGE CROSS

Contd.....

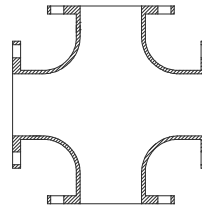

Size (in.)	Item No.	List Price (\$)	Wt. (lb.)
48X14	DFX4814	39,101.00	4385
48X16	DFX4816	39,369.00	4415
48X18	DFX4818	39,414.00	4420
48X20	DFX4820	39,770.00	4460
48X24	DFX4824	40,439.00	4535
48X30	DFX4830	41,642.00	5705
48X36	DFX4836	52,430.00	7310
48X42	DFX4842	68,032.00	7630
48X48	DFX4848	71,377.00	8005
54X12	DFX5412	POA	4575

Size (in.)	Item No.	List Price (\$)	Wt. (lb.)
54X14	DFX5414	POA	4575
54X16	DFX5416	POA	4605
54X18	DFX5418	POA	4625
54X20	DFX5420	POA	4665
54X24	DFX5424	POA	4700
54X30	DFX5430	POA	4800
54X36	DFX5436	POA	4950
54X42	DFX5442	POA	6210
54X48	DFX5448	POA	6425
54X54	DFX5454	POA	6780

FLANGE LATERAL WYES

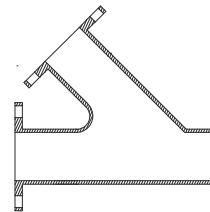

Size (in.)	Item No.	List Price (\$)	Wt. (lb.)
3 X 3	DFY0303	323.00	45
4 X 2	DFY0402	389.00	56
4 X 3	DFY0403	465.00	65
4 X 4	DFY0404	429.00	75
6 X 3	DFY0603	704.00	102
6 X 4	DFY0604	811.00	105
6 X 6	DFY0606	687.00	120
8 X 4	DFY0804	1,269.00	165
8 X 6	DFY0806	1,215.00	175
8 X 8	DFY0808	1,122.00	200
10 X 4	DFY1004	1,828.00	240
10 X 6	DFY1006	1,902.00	250
10 X 8	DFY1008	2,077.00	335
10 X 10	DFY1010	1,801.00	335
12 X 4	DFY1204	2,671.00	350
12 X 6	DFY1206	2,778.00	427
12 X 8	DFY1208	2,742.00	452

Size (in.)	Item No.	List Price (\$)	Wt. (lb.)
12 X 10	DFY1210	3,199.00	420
12 X 12	DFY1212	2,754.00	515
14 X 6	DFY1406	3,654.00	475
14 X 8	DFY1408	3,830.00	500
14 X 10	DFY1410	3,690.00	525
14 X 12	DFY1412	4,355.00	570
14 X 14	DFY1414	4,251.00	605
16 X 6	DFY1606	4,355.00	620
16 X 8	DFY1608	4,985.00	645
16 X 10	DFY1610	5,196.00	675
16 X 12	DFY1612	5,021.00	715
16 X 14	DFY1614	5,829.00	755
16 X 16	DFY1616	5,657.00	805
18 X 6	DFY1806	3,266.00	458
18 X 8	DFY1808	4,534.00	780
18 X 10	DFY1810	6,417.00	810
18 X 12	DFY1812	6,743.00	850

Contd.....

CALL FOR BARE/BARE FITTINGS

FLANGE LATERAL WYES

Contd.....

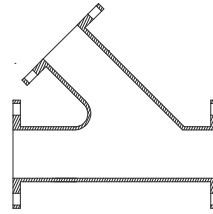

Size (in.)	Item No.	List Price (\$)	Wt. (lb.)
18 X 14	DFY1814	7,071.00	885
18 X 16	DFY1816	7,431.00	935
18 X 18	DFY1818	7,104.00	1035
20 X 8	DFY2008	5,777.00	740
20 X 10	DFY2010	6,288.00	1025
20 X 12	DFY2012	8,666.00	1065
20 X 14	DFY2014	9,487.00	1110
20 X 16	DFY2016	9,913.00	1155
20 X 18	DFY2018	9,366.00	1200
20 X 20	DFY2020	9,875.00	1265
24 X 6	DFY2406	8,276.00	1020
24 X 8	DFY2408	8,431.00	1425
24 X 10	DFY2410	11,747.00	1460
24 X 12	DFY2412	9,366.00	1550
24 X 14	DFY2414	13,657.00	1560
24 X 16	DFY2416	14,749.00	1615
24 X 18	DFY2418	14,480.00	1680
24 X 20	DFY2420	13,657.00	1750
24 X 24	DFY2424	14,868.00	1905
30 X 12	DFY3012	23,369.00	2545
30 X 14	DFY3014	23,830.00	2590
30 X 16	DFY3016	24,289.00	2645
30 X 18	DFY3018	24,748.00	2690
30 X 20	DFY3020	25,414.00	2760
30 X 24	DFY3024	26,796.00	2915
30 X 30	DFY3030	26,962.00	3225
36 X 12	DFY3612	37,538.00	4490
36 X 14	DFY3614	37,996.00	4545

Size (in.)	Item No.	List Price (\$)	Wt. (lb.)
36 X 16	DFY3616	37,246.00	4000
36 X 18	DFY3618	39,042.00	4670
36 X 20	DFY3620	38,248.00	4750
36 X 24	DFY3624	39,502.00	4920
36 X 30	DFY3630	43,470.00	5255
36 X 36	DFY3636	47,983.00	5740
42 X 12	DFY4212	51,048.00	5725
42 X 14	DFY4214	51,716.00	5800
42 X 16	DFY4216	52,162.00	5850
42 X 18	DFY4218	53,501.00	6000
42 X 20	DFY4220	54,483.00	6680
42 X 24	DFY4224	55,775.00	6850
42 X 30	DFY4230	61,126.00	7185
42 X 36	DFY4236	68,214.00	7670
42 X 42	DFY4242	81,763.00	9185
48 X 12	DFY4812	64,200.00	7200
48 X 14	DFY4814	64,869.00	7276
48 X 16	DFY4816	65,983.00	7400
48 X 18	DFY4818	67,943.00	7620
48 X 20	DFY4820	68,524.00	7685
48 X 24	DFY4824	60,992.00	8695
48 X 30	DFY4830	71,466.00	5573
48 X 36	DFY4836	79,981.00	9515
48 X 42	DFY4842	98,170.00	11030
48 X 48	DFY4848	1,07,889.00	12115
54 X 48	DFY5448	POA	9480
54 X 54	DFY5454	POA	11780
60 X 30	DFY6030	POA	9045

CALL FOR BARE/BARE FITTINGS

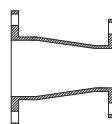
CONCENTRIC REDUCER

Size (in.)	Item No.	List Price (\$)	Wt. (lb.)
3 X 2	DFCR0302	120.00	16
3 X 2.5	DFCR0302.5	POA	21
4 X 2	DFCR0402	182.00	25
4 X 2½	DFCR04025	POA	26
4 X 3	DFCR0403	175.00	30
5 X 3	DFCR0503	POA	
5 X 4	DFCR0504	POA	
6 X 2	DFCR0602	250.00	35
6 X 3	DFCR0603	284.00	40
6 X 4	DFCR0604	272.00	45
6 X 5	DFCR0605	361.00	52
8 X 3	DFCR0803	POA	60
8 X 4	DFCR0804	407.00	65
8 X 5	DFCR0805	497.00	70
8 X 6	DFCR0806	441.00	75
10 X 4	DFCR1004	604.00	85
10 X 6	DFCR1006	577.00	90
10 X 8	DFCR1008	719.00	110
12 X 4	DFCR1204	845.00	120
12 X 6	DFCR1206	854.00	130
12 X 8	DFCR1208	953.00	145
12 X 10	DFCR1210	1,078.00	170
14 X 6	DFCR1406	1,092.00	155
14 X 8	DFCR1408	1,232.00	175
14 X 10	DFCR1410	1,353.00	190
14 X 12	DFCR1412	1,273.00	248
16 X 6	DFCR1606	1,341.00	190
16 X 8	DFCR1608	1,215.00	210
16 X 10	DFCR1610	1,365.00	235
16 X 12	DFCR1612	1,807.00	265
16 X 14	DFCR1614	1,969.00	280
18 X 8	DFCR1808	1,742.00	240
18 X 10	DFCR1810	1,925.00	265
18 X 12	DFCR1812	1,882.00	295
18 X 14	DFCR1814	2,252.00	310
18 X 16	DFCR1816	2,176.00	340
20 X 6	DFCR2006	2,345.00	306

Size (in.)	Item No.	List Price (\$)	Wt. (lb.)
20 X 8	DFCR2008	2,230.00	295
20 X 10	DFCR2010	2,425.00	310
20 X 12	DFCR2012	2,315.00	345
20 X 14	DFCR2014	2,778.00	355
20 X 16	DFCR2016	2,486.00	390
20 X 18	DFCR2018	3,204.00	410
24 X 8	DFCR2408	3,203.00	410
24 X 10	DFCR2410	3,672.00	472
24 X 12	DFCR2412	3,987.00	480
24 X 14	DFCR2414	4,094.00	490
24 X 16	DFCR2416	3,449.00	525
24 X 18	DFCR2418	4,296.00	550
24 X 20	DFCR2420	4,607.00	590
30 X 12	DFCR3012	6,443.00	825
30 X 14	DFCR3014	POA	
30 X 16	DFCR3016	6,523.00	770
30 X 18	DFCR3018	6,777.00	810
30 X 20	DFCR3020	7,279.00	870
30 X 24	DFCR3024	8,115.00	970
36 X 16	DFCR3616	9,240.00	1105
36 X 18	DFCR3618	9,701.00	1165
36 X 20	DFCR3620	10,288.00	1230
36 X 24	DFCR3624	11,251.00	1345
36 X 30	DFCR3630	13,005.00	1555
42 X 20	DFCR4220	POA	1712
42 X 24	DFCR4224	16,233.00	1820
42 X 30	DFCR4230	18,371.00	2060
42 X 36	DFCR4236	20,914.00	2550
48 X 24	DFCR4824	20,822.00	1350
48 X 30	DFCR4830	23,409.00	2625
48 X 36	DFCR4836	26,308.00	2950
48 X 42	DFCR4842	29,609.00	3320
54X30	DFCR5430	POA	1625
54X36	DFCR5436	POA	1680
54X42	DFCR5442	POA	1800
54X48	DFCR5448	POA	1695

CALL FOR BARE/BARE FITTINGS

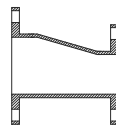
ECCENTRIC REDUCER

Size (in.)	Item No.	List Price (\$)	Wt. (lb.)
3 X 2	DFER0302	120.00	16
4 X 2	DFER0402	182.00	25
4 X 3	DFER0403	216.00	30
5 X 4	DFER0504	POA	33
6 X 2	DFER0602	POA	35
6 X 3	DFER0603	284.00	40
6 X 4	DFER0604	323.00	45
6 X 5	DFER0605	369.00	52
8 X 3	DFER0803	POA	60
8 X 4	DFER0804	465.00	65
8 X 5	DFER0805	497.00	70
8 X 6	DFER0806	532.00	75
10 X 4	DFER1004	604.00	85
10 X 6	DFER1006	637.00	90
10 X 8	DFER1008	776.00	110
12 X 4	DFER1204	845.00	120
12 X 6	DFER1206	918.00	130
12 X 8	DFER1208	1,024.00	145
12 X 10	DFER1210	1,199.00	170
14 X 6	DFER1406	1,092.00	155
14 X 8	DFER1408	1,199.00	175
14 X 10	DFER1410	1,341.00	190
14 X 12	DFER1412	1,584.00	248
16 X 6	DFER1606	1,341.00	190
16 X 8	DFER1608	1,477.00	210
16 X 10	DFER1610	1,655.00	235
16 X 12	DFER1612	1,864.00	265
16 X 14	DFER1614	1,969.00	280
18 X 8	DFER1808	1,742.00	240
18 X 10	DFER1810	1,925.00	265
18 X 12	DFER1812	2,144.00	295
18 X 14	DFER1814	2,252.00	310
18 X 16	DFER1816	2,468.00	340
20 X 8	DFER2008	2,267.00	297
20 X 10	DFER2010	2,425.00	310

Size (in.)	Item No.	List Price (\$)	Wt. (lb.)
20 X 12	DFER2012	2,698.00	345
20 X 14	DFER2014	2,778.00	355
20 X 16	DFER2016	3,047.00	390
20 X 18	DFER2018	3,203.00	410
24 X 8	DFER2408	3,596.00	465
24 X 10	DFER2410	3,672.00	473
24 X 12	DFER2412	3,750.00	480
24 X 14	DFER2414	3,828.00	490
24 X 16	DFER2416	4,103.00	525
24 X 18	DFER2418	4,296.00	550
24 X 20	DFER2420	4,607.00	590
30 X 10	DFER3010	6,326.00	760
30 X 14	DFER3014	8,115.00	825
30 X 16	DFER3016	7,822.00	770
30 X 18	DFER3018	6,818.00	810
30 X 20	DFER3020	7,279.00	870
30 X 24	DFER3024	8,115.00	970
36 X 14	DFER3614	10,789.00	1290
36 X 16	DFER3616	9,325.00	1105
36 X 18	DFER3618	9,701.00	1164
36 X 20	DFER3620	10,245.00	1230
36 X 24	DFER3624	11,206.00	1345
36 X 30	DFER3630	12,962.00	1555
42 X 20	DFER4220	POA	1712
42 X 24	DFER4224	16,233.00	1820
42 X 30	DFER4230	18,371.00	2060
42 X 36	DFER4236	20,914.00	2550
48 X 24	DFER4824	22,288.00	2562
48 X 30	DFER4830	23,409.00	2625
48 X 36	DFER4836	26,308.00	2950
48 X 42	DFER4842	29,609.00	3320
54 X 30	DFER5430	POA	1625
54 X 36	DFER5436	POA	1680
54 X 42	DFER5442	POA	1800
54 X 48	DFER5448	POA	1695

CALL FOR BARE/BARE FITTINGS

BLIND FLANGES

Size (in.)	Item No.	List Price (\$)	Wt. (lb.)
2	DBF02	POA	9
3	DBF03	70.00	9
4	DBF04	121.00	16
6	DBF06	180.00	25
8	DBF08	300.00	42
10	DBF10	448.00	63
12	DBF12	603.00	85
14	DBF14	844.00	120
16	DBF16	1,024.00	145
18	DBF18	1,415.00	195
20	DBF20	1,912.00	245
24	DBF24	2,843.00	370
30	DBF30	4,178.00	500
36	DBF36	8,015.00	960
42	DBF42	11,575.00	1300
48	DBF48	15,486.00	1740
54	DBF54	POA	2600

**2" TAPPED
BLIND FLANGES**

Size (in.)	Item No.	List Price (\$)	Wt. (lb.)
3	DBFT03	123.00	9
4	DBFT04	172.00	16
6	DBFT06	234.00	25
8	DBFT08	355.00	42
10	DBFT10	500.00	63
12	DBFT12	657.00	85
14	DBFT14	930.00	120
16	DBFT16	1,113.00	145
18	DBFT18	1,527.00	195
20	DBFT20	2,025.00	245
24	DBFT24	2,957.00	370
30	DBFT30	4,343.00	500
36	DBFT36	8,181.00	960
42	DBFT42	11,796.00	1300
48	DBFT48	15,712.00	1740
54	DBFT54	POA	2600

CALL FOR BARE/BARE FITTINGS

Utility Pipe Fittings Zinc Coated

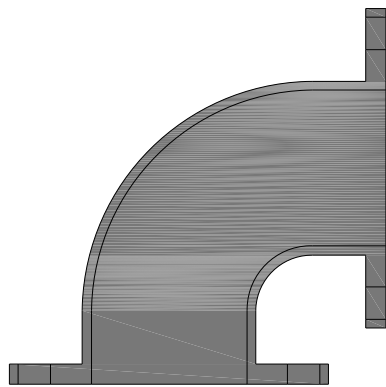

ANSI/AWWA C110/A21.10
FLANGE FITTINGS
ZINC COATED

PRICE LIST

Effective December 16, 2024

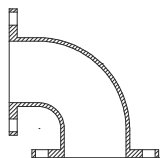

FLANGE BENDS
90° (1/4)

Size (in.)	Item No.	List Price (\$)	Wt. (lb.)
2	DFB9002Z	167.00	14
3	DFB9003Z	212.00	25
4	DFB9004Z	325.00	45
6	DFB9006Z	503.00	65
8	DFB9008Z	826.00	105
10	DFB9010Z	1,303.00	165
12	DFB9012Z	1,688.00	235
14	DFB9014Z	2,210.00	290
16	DFB9016Z	2,737.00	370
18	DFB9018Z	3,733.00	450
20	DFB9020Z	4,582.00	580
24	DFB9024Z	7,510.00	900
30	DFB9030Z	12,895.00	1430
36	DFB9036Z	19,111.00	2135
42	DFB9042Z	32,155.00	3055
48	DFB9048Z	43,077.00	4095
54	DFB9054Z	POA	3740

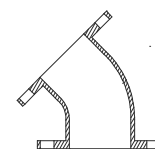
FLANGE BENDS
45° (1/8)

Size (in.)	Item No.	List Price (\$)	Wt. (lb.)
2	DFB4502Z	172.00	12
3	DFB4503Z	163.00	20
4	DFB4504Z	289.00	40
6	DFB4506Z	445.00	55
8	DFB4508Z	682.00	90
10	DFB4510Z	1,096.00	130
12	DFB4512Z	1,427.00	195
14	DFB4514Z	1,689.00	220
16	DFB4516Z	2,146.00	280
18	DFB4518Z	2,882.00	325
20	DFB4520Z	3,863.00	430
24	DFB4524Z	5,344.00	630
30	DFB4530Z	11,162.00	1120
36	DFB4536Z	17,487.00	1755
42	DFB4542Z	27,349.00	2600
48	DFB4548Z	37,658.00	3580
54	DFB4554Z	POA	2735

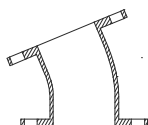
FLANGE BENDS
22½° (1/16)

Size (in.)	Item No.	List Price (\$)	Wt. (lb.)
2	DFB2202Z	POA	12
3	DFB2203Z	178.00	20
4	DFB2204Z	288.00	40
6	DFB2206Z	428.00	55
8	DFB2208Z	666.00	90
10	DFB2210Z	1,048.00	135
12	DFB2212Z	1,531.00	205
14	DFB2214Z	1,933.00	225
16	DFB2216Z	2,217.00	285
18	DFB2218Z	2,971.00	335
20	DFB2220Z	4,095.00	435
24	DFB2224Z	6,020.00	640
30	DFB2230Z	11,310.00	1135
36	DFB2236Z	17,835.00	1790
42	DFB2242Z	28,037.00	2665
48	DFB2248Z	38,555.00	3665
54	DFB2254Z	POA	2260

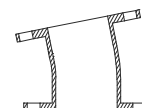
FLANGE BENDS
11¼° (1/32)

Size (in.)	Item No.	List Price (\$)	Wt. (lb.)
2	DFB1102Z	POA	12
3	DFB1103Z	178.00	20
4	DFB1104Z	334.00	40
6	DFB1106Z	516.00	55
8	DFB1108Z	704.00	90
10	DFB1110Z	1,162.00	135
12	DFB1112Z	1,764.00	205
14	DFB1114Z	2,010.00	225
16	DFB1116Z	2,449.00	285
18	DFB1118Z	2,971.00	335
20	DFB1120Z	4,095.00	435
24	DFB1124Z	6,329.00	645
30	DFB1130Z	11,461.00	1150
36	DFB1136Z	17,986.00	1805
42	DFB1142Z	28,193.00	2680
48	DFB1148Z	38,869.00	3695
54	DFB1154Z	POA	2100

90° LONG RADIUS BENDS

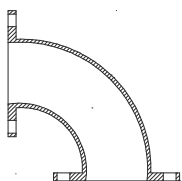

Size (in.)	Item No.	List Price (\$)	Wt. (lb.)
3	DFBLR9003Z	263.00	30
4	DFBLR9004Z	441.00	30
6	DFBLR9006Z	760.00	80
8	DFBLR9008Z	1,260.00	140
10	DFBLR9010Z	1,847.00	215
12	DFBLR9012Z	2,792.00	325
14	DFBLR9014Z	3,304.00	580
16	DFBLR9016Z	4,334.00	740
18	DFBLR9018Z	5,577.00	840
20	DFBLR9020Z	7,622.00	928
24	DFBLR9024Z	11,665.00	1640
30	DFBLR9030Z	20,974.00	2105
36	DFBLR9036Z	32,729.00	3285
42	DFBLR9042Z	51,177.00	4865
48	DFBLR9048Z	71,422.00	7800
54	DFBLR9054Z	POA	6205

90° FLANGE X FLARE BENDS

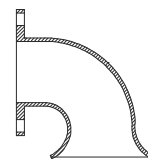

Size (in.)	Item No.	List Price (\$)	Wt. (lb.)
3	DFF9003Z	222.00	25
4	DFF9004Z	394.00	40
6	DFF9006Z	605.00	70
8	DFF9008Z	1,031.00	110
10	DFF9010Z	1,678.00	175
12	DFF9012Z	2,105.00	245
14	DFF9014Z	2,917.00	340
16	DFF9016Z	3,946.00	460
18	DFF9018Z	4,960.00	560
20	DFF9020Z	6,586.00	700
24	DFF9024Z	9,531.00	1100
30	DFF9030Z	19,629.00	1840
36	DFF9036Z	27,197.00	2700
42	DFF9042Z	33,661.00	3250
48	DFF9048Z	55,067.00	4215
54	DFF9054Z	POA	3965

STRAIGHT FLANGE X FLARE

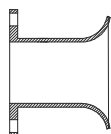

Size (in.)	Item No.	List Price (\$)	Wt. (lb.)
3	DFP03Z	178.00	20
4	DFP04Z	263.00	30
6	DFP06Z	345.00	40
8	DFP08Z	605.00	70
10	DFP10Z	820.00	95
12	DFP12Z	1,335.00	115
14	DFP14Z	1,421.00	190
16	DFP16Z	2,061.00	330
18	DFP18Z	2,440.00	355
20	DFP20Z	3,354.00	460
24	DFP24Z	4,518.00	635
30	DFP30Z	10,960.00	1025
36	DFP36Z	POA	1460
42	DFP42Z	POA	1900
48	DFP48Z	POA	2350
54	DFP54Z	POA	2035

LONG RADIUS 90° FLANGE X FLARE BENDS

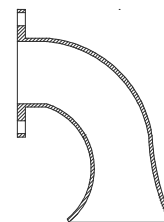

Size (in.)	Item No.	List Price (\$)	Wt. (lb.)
3	DFFLR9003Z	POA	30
4	DFFLR9004Z	POA	50
6	DFFLR9006Z	776.00	90
8	DFFLR9008Z	1,335.00	115
10	DFFLR9010Z	2,149.00	250
12	DFFLR9012Z	3,219.00	375
14	DFFLR9014Z	4,289.00	500
16	DFFLR9016Z	6,130.00	715
18	DFFLR9018Z	7,081.00	800
20	DFFLR9020Z	10,722.00	1140
24	DFFLR9024Z	12,562.00	1335
30	DFFLR9030Z	21,819.00	2190
36	DFFLR9036Z	34,522.00	3465
42	DFFLR9042Z	54,172.00	5150
48	DFFLR9048Z	70,737.00	6725

ZINC
ZINC
ZINC
ZINC

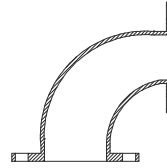
90° REDUCING BENDS

Size (in.)	Item No.	List Price (\$)	Wt. (lb.)
4 X 3	DFBR0403Z	256.00	35
6 X 3	DFBR0603Z	484.00	45
6 X 4	DFBR0604Z	476.00	55
6 X 5	DFBR0605Z	484.00	
8 X 4	DFBR0804Z	649.00	80
8 X 6	DFBR0806Z	738.00	90
10X 4	DFBR1004Z	1,119.00	105
10X 6	DFBR1006Z	1,162.00	125
10X 8	DFBR1008Z	1,289.00	150
12X 4	DFBR1204Z	1,204.00	
12X 6	DFBR1206Z	1,376.00	165
12X 8	DFBR1208Z	1,619.00	190
12X10	DFBR1210Z	1,716.00	220
14X 6	DFBR1406Z	1,635.00	144
14X 8	DFBR1408Z	1,847.00	200
14X10	DFBR1410Z	2,061.00	260
14X12	DFBR1412Z	2,320.00	270
16X 6	DFBR1606Z	POA	220
16X 8	DFBR1608Z	2,061.00	240
16X10	DFBR1610Z	2,406.00	344
16X12	DFBR1612Z	2,660.00	373
16X14	DFBR1614Z	2,877.00	330
18X 6	DFBR1806Z	POA	260
18X 8	DFBR1808Z	POA	280
18X10	DFBR1810Z	2,926.00	320
18X12	DFBR1812Z	3,103.00	465
18X14	DFBR1814Z	3,413.00	370
18X16	DFBR1816Z	3,718.00	410
20X 6	DFBR2006Z	POA	320
20X 8	DFBR2008Z	POA	345
20X10	DFBR2010Z	POA	385
20X12	DFBR2012Z	4,276.00	415
20X14	DFBR2014Z	4,776.00	518
20X16	DFBR2016Z	4,661.00	533
20X18	DFBR2018Z	4,945.00	515
24X 6	DFBR2406Z	POA	480
24X 8	DFBR2408Z	POA	505
24X10	DFBR2410Z	POA	545
24X12	DFBR2412Z	5,414.00	575
24X14	DFBR2414Z	5,976.00	595
24X16	DFBR2416Z	6,447.00	635
24X18	DFBR2418Z	6,508.00	675
24X20	DFBR2420Z	6,962.00	740

Size (in.)	Item No.	List Price (\$)	Wt. (lb.)
30X12	DFBR3012Z	8,371.00	840
30X14	DFBR3014Z	10,307.00	860
30X16	DFBR3016Z	8,967.00	900
30X18	DFBR3018Z	13,310.00	940
30X20	DFBR3020Z	14,117.00	1005
30X24	DFBR3024Z	12,009.00	1165
36X12	DFBR3612Z	11,908.00	1195
36X14	DFBR3614Z	15,241.00	1215
36X16	DFBR3616Z	12,508.00	1255
36X18	DFBR3618Z	16,119.00	1295
36X20	DFBR3620Z	16,693.00	1315
36X24	DFBR3624Z	15,795.00	1520
36X30	DFBR3630Z	18,330.00	1785
42X12	DFBR4212Z	POA	1655
42X14	DFBR4214Z	21,172.00	1675
42X16	DFBR4216Z	18,044.00	1715
42X18	DFBR4218Z	23,856.00	1755
42X20	DFBR4220Z	23,604.00	1820
42X24	DFBR4224Z	20,832.00	1980
42X30	DFBR4230Z	24,670.00	2245
42X36	DFBR4236Z	35,661.00	2600
48X12	DFBR4812Z	22,881.00	2175
48X14	DFBR4814Z	27,389.00	2195
48X16	DFBR4816Z	23,514.00	2235
48X18	DFBR4818Z	33,123.00	2275
48X20	DFBR4820Z	35,793.00	2340
48X24	DFBR4824Z	34,082.00	2500
48X30	DFBR4830Z	37,253.00	2765
48X36	DFBR4836Z	37,478.00	3115
48X42	DFBR4842Z	49,281.00	3580
54X12	DFBR5412Z	POA	1990
54X14	DFBR5414Z	POA	2015
54X16	DFBR5416Z	POA	2055
54X18	DFBR5418Z	POA	2095
54X20	DFBR5420Z	POA	2160
54X24	DFBR5424Z	POA	2320
54X30	DFBR5430Z	POA	2585
54X36	DFBR5436Z	POA	2940
54X42	DFBR5442Z	POA	3395
54X48	DFBR5448Z	POA	3565

90° BASE BENDS

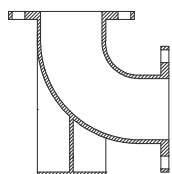

Size (in.)	Item No.	List Price (\$)	Wt. (lb.)
3	DFBB9003Z	304.00	35
4	DFBB9004Z	476.00	55
6	DFBB9006Z	698.00	85
8	DFBB9008Z	1,318.00	145
10	DFBB9010Z	1,804.00	210
12	DFBB9012Z	2,571.00	300
14	DFBB9014Z	3,090.00	320
16	DFBB9016Z	3,819.00	445
18	DFBB9018Z	5,005.00	565
20	DFBB9020Z	6,586.00	700
24	DFBB9024Z	9,691.00	1030
30	DFBB9030Z	16,192.00	1625
36	DFBB9036Z	23,762.00	2385
42	DFBB9042Z	43,983.00	3465
48	DFBB9048Z	48,492.00	4610
54	DFBB9054Z	POA	4415

90° LONG RADIUS BASE BENDS

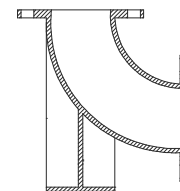

Size (in.)	Item No.	List Price (\$)	Wt. (lb.)
3	DFBBLR9003Z	330.00	40
4	DFBBLR9004Z	518.00	60
6	DFBBLR9006Z	859.00	100
8	DFBBLR9008Z	1,547.00	180
10	DFBBLR9010Z	2,256.00	260
12	DFBBLR9012Z	3,537.00	390
14	DFBBLR9014Z	3,579.00	650
16	DFBBLR9016Z	6,344.00	815
18	DFBBLR9018Z	7,081.00	955
20	DFBBLR9020Z	9,268.00	1200
24	DFBBLR9024Z	13,450.00	1770
30	DFBBLR9030Z	23,908.00	2295
36	DFBBLR9036Z	36,659.00	3535
42	DFBBLR9042Z	58,012.00	5275
48	DFBBLR9048Z	80,308.00	7305
54	DFBBLR9054Z	POA	6880

BASE TEES

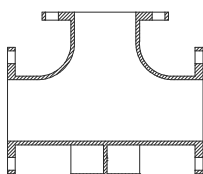

Size (in.)	Item No.	List Price (\$)	Wt. (lb.)
3	DFTB0303Z	394.00	45
4	DFTB0404Z	649.00	75
6	DFTB0606Z	948.00	110
8	DFTB0808Z	1,594.00	185
10	DFTB1010Z	2,575.00	300
12	DFTB1212Z	3,689.00	430
14	DFTB1414Z	4,162.00	500
16	DFTB1616Z	5,145.00	600
18	DFTB1818Z	6,551.00	740
20	DFTB2020Z	8,748.00	930
24	DFTB2424Z	13,265.00	1410
30	DFTB3030Z	22,617.00	2270
36	DFTB3636Z	33,072.00	3320
42	DFTB4242Z	61,533.00	5850
48	DFTB4848Z	81,202.00	7720
54	DFTB5454Z	POA	6465

ZINC

ZINC

ZINC

ZINC

ZINC

ZINC

90° REDUCING BASE BENDS

(WITH BASE UNDER SMALL END)

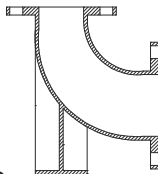

R - Available multiple size reductions.

Size (in.)	Item No.	List Price (\$)	Wt. (lb.)
4 X 3	DFBBSDR0403Z	POA	45
6 X 4	DFBBSDR0604Z	POA	75
8 X 4	DFBBSDR0804Z	POA	120
8 X 6	DFBBSDR0806Z	POA	130
10X 6	DFBBSDR1006Z	POA	170
10X 8	DFBBSDR1008Z	POA	195
12X 6	DFBBSDR1206Z	POA	230
12X 8	DFBBSDR1208Z	POA	255
12X10	DFBBSDR1210Z	POA	285
14X R	DFBBSDR14Z	POA	
16X R	DFBBSDR16Z	POA	
18X R	DFBBSDR18Z	POA	
20X R	DFBBSDR20Z	POA	
24X R	DFBBSDR24Z	POA	
30X R	DFBBSDR30Z	POA	
36X R	DFBBSDR36Z	POA	
42X R	DFBBSDR42Z	POA	
48X R	DFBBSDR48Z	POA	
54X R	DFBBSDR54Z	POA	

90° REDUCING BASE BENDS

(WITH BASE UNDER LARGE END)

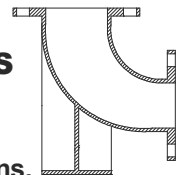

R - Available multiple size reductions.

Size (in.)	Item No.	List Price (\$)	Wt. (lb.)
4 X 3	DFBBLDR0403Z	POA	45
6 X 4	DFBBLDR0604Z	POA	75
8 X 4	DFBBLDR0804Z	POA	120
8 X 6	DFBBLDR0806Z	POA	130
10X 6	DFBBLDR1006Z	POA	170
10X 8	DFBBLDR1008Z	POA	195
12X 6	DFBBLDR1206Z	POA	230
12X 8	DFBBLDR1208Z	POA	255
12X10	DFBBLDR1210Z	POA	285
14X R	DFBBLDR14Z	POA	
16X R	DFBBLDR16Z	POA	
18X R	DFBBLDR18Z	POA	
20X R	DFBBLDR20Z	POA	
24X R	DFBBLDR24Z	POA	
30X R	DFBBLDR30Z	POA	
36X R	DFBBLDR36Z	POA	
42X R	DFBBLDR42Z	POA	
48X R	DFBBLDR48Z	POA	
54X R	DFBBLDR54Z	POA	

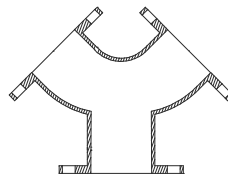
TRUE WYES

Size (in.)	Item No.	List Price (\$)	Wt. (lb.)
4 X 4 X 4	DFYT040404Z	434.00	50
6 X 4 X 4	DFYT060404Z	POA	75
6 X 6 X 6	DFYT060606Z	691.00	80
8 X 6 X 6	DFYT080606Z	POA	120
8 X 8 X 4	DFYT080804Z	POA	
8 X 8 X 8	DFYT080808Z	1,204.00	125
10 X 10 X 6	DFYT101006Z	POA	
10 X 8 X 8	DFYT100808Z	1,335.00	155
10 X 10 X 10	DFYT101010Z	1,594.00	185
12 X 12 X 6	DFYT121206Z	POA	
12 X 12 X 8	DFYT121208Z	POA	

Size (in.)	Item No.	List Price (\$)	Wt. (lb.)
12 X 12 X 10	DFYT121210Z	POA	
12 X 12 X 12	DFYT121212Z	2,575.00	300
14 X 14 X 14	DFYT141414Z	POA	415
16 X 16 X 16	DFYT161616Z	POA	580
18 X 18 X 18	DFYT181818Z	POA	680
20 X 20 X 20	DFYT202020Z	POA	960
24 X 24 X 24	DFYT242424Z	POA	1370
30 X 30 X 30	DFYT303030Z	POA	80
36 X 36 X 36	DFYT363636Z	POA	120
42 X 42 X 42	DFYT424242Z	POA	125
48 X 48 X 48	DFYT484848Z	POA	120

FLANGE TEES

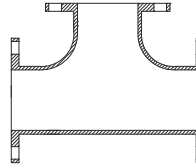

Size (in.)	Item No.	List Price (\$)	Wt. (lb.)
2 X 2	DFT0202Z	210.00	20
3 X 2	DFT0302Z	304.00	35
3 X 3	DFT0303Z	300.00	40
4 X 2	DFT0402Z	434.00	50
4 X 3	DFT0403Z	518.00	60
4 X 4	DFT0404Z	565.00	65
5 X 5	DFT0505Z	POA	80
6 X 2	DFT0602Z	738.00	156
6 X 3	DFT0603Z	738.00	85
6 X 4	DFT0604Z	776.00	90
6 X 6	DFT0606Z	739.00	95
8 X 3	DFT0803Z	1,189.00	130
8 X 4	DFT0804Z	1,142.00	140
8 X 6	DFT0806Z	1,063.00	145
8 X 8	DFT0808Z	1,229.00	155
10 X 4	DFT1004Z	1,597.00	205
10 X 6	DFT1006Z	1,524.00	215
10 X 8	DFT1008Z	1,601.00	225
10 X 10	DFT1010Z	1,860.00	270
12 X 4	DFT1204Z	2,183.00	290
12 X 6	DFT1206Z	2,123.00	295
12 X 8	DFT1208Z	2,238.00	310
12 X 10	DFT1210Z	2,637.00	360
12 X 12	DFT1212Z	2,693.00	385
14 X 4	DFT1404Z	POA	370
14 X 6	DFT1406Z	3,219.00	375
14 X 8	DFT1408Z	3,347.00	390
14 X 10	DFT1410Z	3,431.00	400
14 X 12	DFT1412Z	3,647.00	425
14 X 14	DFT1414Z	3,734.00	435
16 X 4	DFT1604Z	POA	460
16 X 6	DFT1606Z	3,754.00	465
16 X 8	DFT1608Z	3,671.00	475
16 X 10	DFT1610Z	4,221.00	495
16 X 12	DFT1612Z	4,076.00	520
16 X 14	DFT1614Z	4,548.00	530
16 X 16	DFT1616Z	4,206.00	550
18 X 6	DFT1806Z	3,829.00	480
18 X 8	DFT1808Z	4,606.00	495
18 X 10	DFT1810Z	4,517.00	510

Size (in.)	Item No.	List Price (\$)	Wt. (lb.)
18X12	DFT1812Z	4,926.00	535
18X14	DFT1814Z	5,489.00	630
18X16	DFT1816Z	5,755.00	650
18X18	DFT1818Z	5,367.00	785
20X 6	DFT2006Z	5,742.00	610
20X 8	DFT2008Z	5,835.00	620
20X10	DFT2010Z	5,976.00	635
20X12	DFT2012Z	6,211.00	660
20X14	DFT2014Z	6,259.00	665
20X16	DFT2016Z	7,622.00	810
20X18	DFT2018Z	7,717.00	820
20X20	DFT2020Z	6,791.00	855
24X 4	DFT2404Z	POA	
24X 6	DFT2406Z	6,870.00	845
24X 8	DFT2408Z	8,093.00	860
24X10	DFT2410Z	8,280.00	880
24X12	DFT2412Z	7,189.00	890
24X14	DFT2414Z	8,406.00	900
24X16	DFT2416Z	7,367.00	915
24X18	DFT2418Z	11,477.00	1220
24X20	DFT2420Z	11,808.00	1510
24X24	DFT2424Z	10,748.00	1330
30X 6	DFT3006Z	14,501.00	1450
30X 8	DFT3008Z	14,546.00	
30X10	DFT3010Z	14,847.00	
30X12	DFT3012Z	14,847.00	1490
30X14	DFT3014Z	14,847.00	1490
30X16	DFT3016Z	14,997.00	1505
30X18	DFT3018Z	15,097.00	1515
30X20	DFT3020Z	15,342.00	1540
30X24	DFT3024Z	20,176.00	2025
30X30	DFT3030Z	18,704.00	2150
36X10	DFT3610Z	POA	3082
36X12	DFT3612Z	21,621.00	2170
36X14	DFT3614Z	21,671.00	2175
36X16	DFT3616Z	21,772.00	2185
36X18	DFT3618Z	21,819.00	2190
36X20	DFT3620Z	22,019.00	2210
36X24	DFT3624Z	22,467.00	2255

Contd.....

ZINC ZINC ZINC ZINC ZINC ZINC ZINC ZINC ZINC ZINC

FLANGE TEES

Contd.....

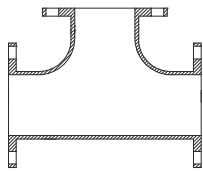

Size (in.)	Item No.	List Price (\$)	Wt. (lb.)
36X30	DFT3630Z	29,885.00	3000
36X36	DFT3636Z	27,790.00	3160
42X12	DFT4212Z	33,294.00	3165
42X14	DFT4214Z	33,347.00	3170
42X16	DFT4216Z	33,451.00	3180
42X18	DFT4218Z	33,503.00	3185
42X20	DFT4220Z	33,717.00	3205
42X24	DFT4224Z	34,136.00	3245
42X30	DFT4230Z	43,391.00	4125
42X36	DFT4236Z	56,381.00	5360
42X42	DFT4242Z	58,695.00	5580
48X12	DFT4812Z	45,392.00	4315
48X14	DFT4814Z	45,392.00	4315
48X16	DFT4816Z	45,547.00	4330
48X18	DFT4818Z	45,547.00	4330
48X20	DFT4820Z	45,756.00	4350
48X24	DFT4824Z	46,124.00	4385
48X30	DFT4830Z	46,864.00	4455
48X36	DFT4836Z	58,432.00	7035
48X42	DFT4842Z	75,680.00	7195
48X48	DFT4848Z	77,680.00	7385
54X12	DFT5412Z	POA	4435
54X14	DFT5414Z	POA	4435
54X16	DFT5416Z	POA	4450
54X18	DFT5418Z	POA	4460
54X20	DFT5420Z	POA	4480
54X24	DFT5424Z	POA	4515
54X30	DFT5430Z	POA	4615
54X36	DFT5436Z	POA	4695
54X42	DFT5442Z	POA	5740
54X48	DFT5448Z	POA	5850
54X54	DFT5454Z	POA	6025

FLANGE TEES - BULL HEAD

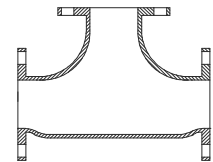

Size (in.)	Item No.	List Price (\$)	Wt. (lb.)
4 X 4 X 6	DFTBH040406Z	POA	90
6 X 6 X 8	DFTBH060608Z	POA	140
8 X 8 X10	DFTBH080810Z	POA	260
8 X 8 X12	DFTBH080812Z	POA	291
10X10X12	DFTBH101012Z	POA	355

FLANGE TEES - REDUCING ON THE RUN

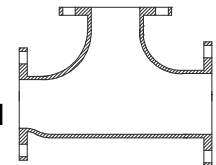

Size (in.)	Item No.	List Price (\$)	Wt. (lb.)
4 X 3 X 3	DFTROR040303Z	POA	55
6 X 4 X 4	DFTROR060404Z	POA	103
6 X 4 X 6	DFTROR060406Z	POA	108
8 X 6 X 4	DFTROR080604Z	POA	146
8 X 6 X 6	DFTROR080606Z	POA	148
8 X 6 X 8	DFTROR080608Z	POA	145
10X 6 X 6	DFTROR100606Z	POA	275
10X 6 X10	DFTROR100610Z	POA	305
10X 8 X 6	DFTROR100806Z	POA	280
10X 8 X 8	DFTROR100808Z	POA	302
10X 8 X10	DFTROR100810Z	POA	325
12X 6 X 6	DFTROR120606Z	POA	340
12X 6 X 8	DFTROR120608Z	POA	360
12X 8 X 6	DFTROR120806Z	POA	355
12X 8 X 8	DFTROR120808Z	POA	375
12X 8 X12	DFTROR120812Z	POA	420
12X10X 6	DFTROR121006Z	POA	390
12X10X 8	DFTROR121008Z	POA	400
12X10X10	DFTROR121010Z	POA	420
12X10X12	DFTROR121012Z	POA	440

FLANGE CROSS

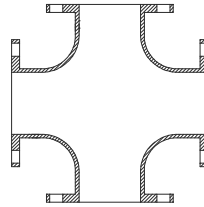

Size (in.)	Item No.	List Price (\$)	Wt. (lb.)
3 X 3	DFX0303Z	434.00	50
4 X 3	DFX0403Z	605.00	70
4 X 4	DFX0404Z	624.00	80
6 X 3	DFX0603Z	820.00	95
6 X 4	DFX0604Z	948.00	110
6 X 6	DFX0606Z	1,007.00	120
8 X 3	DFX0803Z	POA	140
8 X 4	DFX0804Z	1,335.00	155
8 X 6	DFX0806Z	1,421.00	175
8 X 8	DFX0808Z	1,507.00	195
10X 4	DFX1004Z	1,890.00	220
10X 6	DFX1006Z	2,061.00	240
10X 8	DFX1008Z	2,278.00	265
10X10	DFX1010Z	2,834.00	330
12X 4	DFX1204Z	2,660.00	310
12X 6	DFX1206Z	2,744.00	320
12X 8	DFX1208Z	2,963.00	345
12X10	DFX1210Z	3,561.00	415
12X12	DFX1212Z	3,339.00	460
14X 6	DFX1406Z	3,431.00	400
14X 8	DFX1408Z	3,647.00	425
14X10	DFX1410Z	3,946.00	460
14X12	DFX1412Z	4,334.00	505
14X14	DFX1414Z	4,548.00	530
16X 6	DFX1606Z	4,204.00	490
16X 8	DFX1608Z	4,461.00	520
16X10	DFX1610Z	4,760.00	555
16X12	DFX1612Z	5,192.00	605
16X14	DFX1614Z	POA	620
16X16	DFX1616Z	5,703.00	755
18X 6	DFX1806Z	4,475.00	505
18X 8	DFX1808Z	4,738.00	535
18X10	DFX1810Z	4,960.00	560
18X12	DFX1812Z	5,400.00	610
18X14	DFX1814Z	6,373.00	720
18X16	DFX1816Z	6,775.00	765
18X18	DFX1818Z	7,041.00	795
20X 6	DFX2006Z	5,976.00	635
20X 8	DFX2008Z	6,259.00	665

Size (in.)	Item No.	List Price (\$)	Wt. (lb.)
20X10	DFX2010Z	6,447.00	685
20X12	DFX2012Z	6,917.00	735
20X14	DFX2014Z	7,012.00	745
20X16	DFX2016Z	8,610.00	915
20X18	DFX2018Z	8,891.00	945
20X20	DFX2020Z	9,551.00	1015
24X 6	DFX2406Z	8,237.00	875
24X 8	DFX2408Z	8,421.00	895
24X10	DFX2410Z	8,748.00	930
24X12	DFX2412Z	9,032.00	960
24X14	DFX2414Z	9,175.00	975
24X16	DFX2416Z	9,503.00	1010
24X18	DFX2418Z	12,843.00	1365
24X20	DFX2420Z	13,450.00	1430
24X24	DFX2424Z	14,769.00	1570
30X10	DFX3010Z	POA	
30X12	DFX3012Z	15,596.00	1565
30X14	DFX3014Z	15,645.00	1570
30X16	DFX3016Z	15,996.00	1605
30X18	DFX3018Z	16,091.00	1515
30X20	DFX3020Z	16,640.00	1670
30X24	DFX3024Z	22,370.00	2245
30X30	DFX3030Z	24,906.00	2500
36X12	DFX3612Z	22,316.00	2240
36X14	DFX3614Z	22,316.00	2240
36X16	DFX3616Z	22,617.00	2270
36X18	DFX3618Z	22,716.00	2280
36X20	DFX3620Z	23,164.00	2325
36X24	DFX3624Z	23,962.00	2405
36X30	DFX3630Z	32,874.00	3300
36X36	DFX3636Z	36,062.00	3620
42X12	DFX4212Z	34,082.00	3240
42X14	DFX4214Z	34,082.00	3240
42X16	DFX4216Z	34,399.00	3270
42X18	DFX4218Z	34,451.00	3275
42X20	DFX4220Z	34,925.00	3320
42X24	DFX4224Z	35,715.00	4135
42X30	DFX4230Z	46,019.00	4375
42X36	DFX4236Z	60,166.00	5720

Contd.....

ZINC ZINC ZINC ZINC ZINC ZINC ZINC ZINC ZINC ZINC ZINC

ZINC

ZINC

ZINC

ZINC

ZINC

ZINC

FLANGE CROSS

Contd.....

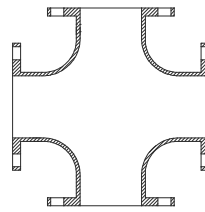

Size (in.)	Item No.	List Price (\$)	Wt. (lb.)
42X42	DFX4242Z	64,744.00	6155
48X12	DFX4812Z	46,178.00	4390
48X14	DFX4814Z	46,124.00	4385
48X16	DFX4816Z	46,444.00	4415
48X18	DFX4818Z	46,493.00	4420
48X20	DFX4820Z	46,914.00	4460
48X24	DFX4824Z	47,705.00	4535
48X30	DFX4830Z	49,122.00	5705
48X36	DFX4836Z	61,848.00	7310
48X42	DFX4842Z	80,256.00	7630
48X48	DFX4848Z	84,202.00	8005

Size (in.)	Item No.	List Price (\$)	Wt. (lb.)
54X12	DFX5412Z	POA	4575
54X14	DFX5414Z	POA	4575
54X16	DFX5416Z	POA	4605
54X18	DFX5418Z	POA	4625
54X20	DFX5420Z	POA	4665
54X24	DFX5424Z	POA	4700
54X30	DFX5430Z	POA	4800
54X36	DFX5436Z	POA	4950
54X42	DFX5442Z	POA	6210
54X48	DFX5448Z	POA	6425
54X54	DFX5454Z	POA	6780

FLANGE LATERAL WYES

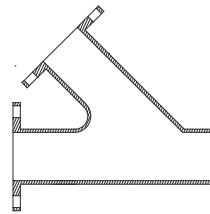

Size (in.)	Item No.	List Price (\$)	Wt. (lb.)
3 X 3	DFY0303Z	394.00	45
4 X 2	DFY0402Z	POA	
4 X 3	DFY0403Z	565.00	65
4 X 4	DFY0404Z	549.00	75
6 X 3	DFY0603Z	POA	
6 X 4	DFY0604Z	990.00	105
6 X 6	DFY0606Z	878.00	120
8 X 4	DFY0804Z	1,547.00	165
8 X 6	DFY0806Z	1,494.00	175
8 X 8	DFY0808Z	1,438.00	200
10X 4	DFY1004Z	2,232.00	240
10X 6	DFY1006Z	2,320.00	250
10X 8	DFY1008Z	2,535.00	335
10X10	DFY1010Z	2,297.00	335
12X 4	DFY1204Z	3,260.00	350
12X 6	DFY1206Z	3,391.00	427
12X 8	DFY1208Z	3,347.00	452

Size (in.)	Item No.	List Price (\$)	Wt. (lb.)
12X10	DFY1210Z	3,905.00	420
12X12	DFY1212Z	3,500.00	515
14X 6	DFY1406Z	4,461.00	475
14X 8	DFY1408Z	4,677.00	500
14X10	DFY1410Z	4,506.00	525
14X12	DFY1412Z	5,316.00	570
14X14	DFY1414Z	5,192.00	605
16X 6	DFY1606Z	5,316.00	620
16X 8	DFY1608Z	6,088.00	645
16X10	DFY1610Z	6,344.00	675
16X12	DFY1612Z	6,130.00	715
16X14	DFY1614Z	7,117.00	755
16X16	DFY1616Z	6,906.00	805
18X 6	DFY1806Z	POA	
18X 8	DFY1808Z	5,537.00	780
18X10	DFY1810Z	7,836.00	810
18X12	DFY1812Z	8,233.00	850

Contd.....

FLANGE LATERAL WYES

Contd.....

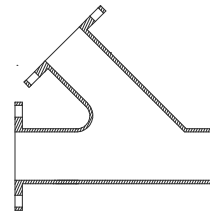

Size (in.)	Item No.	List Price (\$)	Wt. (lb.)
18X14	DFY1814Z	8,632.00	885
18X16	DFY1816Z	9,074.00	935
18X18	DFY1818Z	8,675.00	1035
20X 8	DFY2008Z	POA	740
20X10	DFY2010Z	7,577.00	1025
20X12	DFY2012Z	10,446.00	1065
20X14	DFY2014Z	11,433.00	1110
20X16	DFY2016Z	11,947.00	1155
20X18	DFY2018Z	11,289.00	1200
20X20	DFY2020Z	11,903.00	1265
24X 6	DFY2406Z	POA	
24X 8	DFY2408Z	POA	1425
24X10	DFY2410Z	POA	1460
24X12	DFY2412Z	11,289.00	1550
24X14	DFY2414Z	16,460.00	1560
24X16	DFY2416Z	17,777.00	1615
24X18	DFY2418Z	17,453.00	1680
24X20	DFY2420Z	16,460.00	1750
24X24	DFY2424Z	17,920.00	1905
30X12	DFY3012Z	27,846.00	2545
30X14	DFY3014Z	28,395.00	2590
30X16	DFY3016Z	28,942.00	2645
30X18	DFY3018Z	29,488.00	2690
30X20	DFY3020Z	30,284.00	2760
30X24	DFY3024Z	31,929.00	2915
30X30	DFY3030Z	32,130.00	3225
36X12	DFY3612Z	44,730.00	4490
36X14	DFY3614Z	45,278.00	4545
36X16	DFY3616Z	44,383.00	4000
36X18	DFY3618Z	46,522.00	4670

Size (in.)	Item No.	List Price (\$)	Wt. (lb.)
36X20	DFY3620Z	45,576.00	4750
36X24	DFY3624Z	47,071.00	4920
36X30	DFY3630Z	51,798.00	5255
36X36	DFY3636Z	57,176.00	5740
42X12	DFY4212Z	60,219.00	5725
42X14	DFY4214Z	61,008.00	5800
42X16	DFY4216Z	61,533.00	5850
42X18	DFY4218Z	63,112.00	6000
42X20	DFY4220Z	64,270.00	6680
42X24	DFY4224Z	65,796.00	6850
42X30	DFY4230Z	72,106.00	7185
42X36	DFY4236Z	80,468.00	7670
42X42	DFY4242Z	96,454.00	9185
48X12	DFY4812Z	75,734.00	7200
48X14	DFY4814Z	76,524.00	7276
48X16	DFY4816Z	77,836.00	7400
48X18	DFY4818Z	80,150.00	7620
48X20	DFY4820Z	80,834.00	7685
48X24	DFY4824Z	71,947.00	8695
48X30	DFY4830Z	84,306.00	5573
48X36	DFY4836Z	94,349.00	9515
48X42	DFY4842Z	1,15,807.00	11030
48X48	DFY4848Z	1,27,268.00	12115
54X24	DFY5424Z	POA	6220
54X30	DFY5430Z	POA	7478
54X36	DFY5436Z	POA	7600
54X42	DFY5442Z	POA	8930
54X48	DFY5448Z	POA	9480
54X54	DFY5454Z	POA	11780
60X30	DFY6030Z	POA	9045

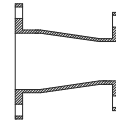
CONCENTRIC REDUCER

Size (in.)	Item No.	List Price (\$)	Wt. (lb.)
3 X 2	DFCR0302Z	144.00	16
4 X 2	DFCR0402Z	222.00	25
4 X 2.5	DFCR0402.5Z	POA	26
4 X 3	DFCR0403Z	223.00	30
6 X 2	DFCR0602Z	304.00	35
6 X 3	DFCR0603Z	345.00	40
6 X 4	DFCR0604Z	346.00	45
6 X 5	DFCR0605Z	440.00	52
8 X 3	DFCR0803Z	POA	60
8 X 4	DFCR0804Z	520.00	65
8 X 5	DFCR0805Z	605.00	70
8 X 6	DFCR0806Z	566.00	75
10X 4	DFCR1004Z	738.00	85
10X 6	DFCR1006Z	734.00	90
10X 8	DFCR1008Z	918.00	110
12X 4	DFCR1204Z	1,031.00	120
12X 6	DFCR1206Z	1,082.00	130
12X 8	DFCR1208Z	1,209.00	145
12X10	DFCR1210Z	1,371.00	170
14X 6	DFCR1406Z	1,335.00	155
14X 8	DFCR1408Z	1,506.00	175
14X10	DFCR1410Z	1,657.00	190
14X12	DFCR1412Z	1,618.00	248
16X 6	DFCR1606Z	1,635.00	190
16X 8	DFCR1608Z	1,545.00	210
16X10	DFCR1610Z	1,736.00	235
16X12	DFCR1612Z	2,227.00	265
16X14	DFCR1614Z	2,406.00	280
18X 8	DFCR1808Z	2,128.00	240
18X10	DFCR1810Z	2,351.00	265
18X12	DFCR1812Z	2,356.00	295
18X14	DFCR1814Z	2,748.00	310
18X16	DFCR1816Z	2,725.00	340
20X 6	DFCR2006Z	POA	

Size (in.)	Item No.	List Price (\$)	Wt. (lb.)
20X 8	DFCR2008Z	POA	
20X10	DFCR2010Z	2,922.00	310
20X12	DFCR2012Z	2,900.00	345
20X14	DFCR2014Z	3,347.00	355
20X16	DFCR2016Z	3,113.00	390
20X18	DFCR2018Z	3,863.00	410
24X 8	DFCR2408Z	POA	410
24X10	DFCR2410Z	POA	
24X12	DFCR2412Z	4,805.00	480
24X14	DFCR2414Z	4,934.00	490
24X16	DFCR2416Z	4,302.00	525
24X18	DFCR2418Z	5,175.00	550
24X20	DFCR2420Z	5,554.00	590
30X12	DFCR3012Z	POA	825
30X16	DFCR3016Z	7,773.00	770
30X18	DFCR3018Z	8,075.00	810
30X20	DFCR3020Z	8,672.00	870
30X24	DFCR3024Z	9,668.00	970
36X16	DFCR3616Z	11,012.00	1105
36X18	DFCR3618Z	11,561.00	
36X20	DFCR3620Z	12,256.00	1230
36X24	DFCR3624Z	13,404.00	1345
36X30	DFCR3630Z	15,495.00	1555
42X24	DFCR4224Z	19,147.00	1820
42X30	DFCR4230Z	21,668.00	2060
42X36	DFCR4236Z	24,670.00	2550
48X30	DFCR4830Z	27,614.00	2625
48X36	DFCR4836Z	31,033.00	2950
48X42	DFCR4842Z	34,925.00	3320
54X30	DFCR5430Z	POA	1625
54X36	DFCR5436Z	POA	1680
54X42	DFCR5442Z	POA	1800
54X48	DFCR5448Z	POA	1695

ECCENTRIC REDUCER

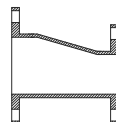

ZINC

ZINC

ZINC

ZINC

ZINC

ZINC

Size (in.)	Item No.	List Price (\$)	Wt. (lb.)
3 X 2	DFER0302Z	POA	16
4 X 2	DFER0402Z	222.00	25
4 X 3	DFER0403Z	263.00	30
6 X 2	DFER0602Z	POA	35
6 X 3	DFER0603Z	345.00	40
6 X 4	DFER0604Z	394.00	45
6 X 5	DFER0605Z	452.00	52
8 X 3	DFER0803Z	POA	60
8 X 4	DFER0804Z	565.00	65
8 X 5	DFER0805Z	605.00	70
8 X 6	DFER0806Z	649.00	75
10X 4	DFER1004Z	738.00	85
10X 6	DFER1006Z	776.00	90
10X 8	DFER1008Z	948.00	110
12X 4	DFER1204Z	1,031.00	120
12X 6	DFER1206Z	1,119.00	130
12X 8	DFER1208Z	1,248.00	145
12X10	DFER1210Z	1,464.00	170
14X 6	DFER1406Z	1,335.00	155
14X 8	DFER1408Z	1,464.00	175
14X10	DFER1410Z	1,635.00	190
14X12	DFER1412Z	1,933.00	248
16X 6	DFER1606Z	1,635.00	190
16X 8	DFER1608Z	1,804.00	210
16X10	DFER1610Z	2,020.00	235
16X12	DFER1612Z	2,278.00	265
16X14	DFER1614Z	2,406.00	280
18X 8	DFER1808Z	2,128.00	240
18X10	DFER1810Z	2,351.00	265
18X12	DFER1812Z	2,618.00	295
18X14	DFER1814Z	2,748.00	310
18X16	DFER1816Z	3,012.00	340
20X 8	DFER2008Z	POA	
20X10	DFER2010Z	2,922.00	310

Size (in.)	Item No.	List Price (\$)	Wt. (lb.)
20X12	DFER2012Z	3,251.00	345
20X14	DFER2014Z	3,347.00	355
20X16	DFER2016Z	3,672.00	390
20X18	DFER2018Z	3,859.00	410
24X 8	DFER2408Z	POA	
24X10	DFER2410Z	POA	
24X12	DFER2412Z	4,518.00	480
24X14	DFER2414Z	4,613.00	490
24X16	DFER2416Z	4,945.00	525
24X18	DFER2418Z	5,175.00	550
24X20	DFER2420Z	5,554.00	590
30X10	DFER3010Z	7,536.00	
30X14	DFER3014Z	9,668.00	825
30X16	DFER3016Z	9,320.00	770
30X18	DFER3018Z	8,123.00	810
30X20	DFER3020Z	8,672.00	870
30X24	DFER3024Z	9,668.00	970
36X14	DFER3614Z	12,854.00	1290
36X16	DFER3616Z	11,112.00	1105
36X18	DFER3618Z	11,561.00	
36X20	DFER3620Z	12,208.00	1230
36X24	DFER3624Z	13,351.00	1345
36X30	DFER3630Z	15,446.00	1555
42X24	DFER4224Z	19,147.00	1820
42X30	DFER4230Z	21,668.00	2060
42X36	DFER4236Z	24,670.00	2550
48X30	DFER4830Z	27,614.00	2625
48X36	DFER4836Z	31,033.00	2950
48X42	DFER4842Z	34,925.00	3320
54X30	DFER5430Z	POA	1625
54X36	DFER5436Z	POA	1680
54X42	DFER5442Z	POA	1800
54X48	DFER5448Z	POA	1695

BLIND FLANGES

Size (in.)	Item No.	List Price (\$)	Wt. (lb.)
2	DBF02Z	POA	9
3	DBF03Z	84.00	9
4	DBF04Z	145.00	16
6	DBF06Z	220.00	25
8	DBF08Z	366.00	42
10	DBF10Z	546.00	63
12	DBF12Z	734.00	85
14	DBF14Z	1,030.00	120
16	DBF16Z	1,248.00	145
18	DBF18Z	1,728.00	195
20	DBF20Z	2,305.00	245
24	DBF24Z	3,427.00	370
30	DBF30Z	4,978.00	500
36	DBF36Z	9,550.00	960
42	DBF42Z	13,652.00	1300
48	DBF48Z	18,270.00	1740
54	DBF54Z	POA	2600

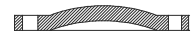
**2" TAPPED
BLIND FLANGES**

Size (in.)	Item No.	List Price (\$)	Wt. (lb.)
3	DBFT03Z	139.00	9
4	DBFT04Z	198.00	16
6	DBFT06Z	273.00	25
8	DBFT08Z	417.00	42
10	DBFT10Z	600.00	63
12	DBFT12Z	788.00	85
14	DBFT14Z	1,117.00	120
16	DBFT16Z	1,337.00	145
18	DBFT18Z	1,840.00	195
20	DBFT20Z	2,416.00	245
24	DBFT24Z	3,540.00	370
30	DBFT30Z	5,145.00	500
36	DBFT36Z	9,717.00	960
42	DBFT42Z	13,874.00	1300
48	DBFT48Z	18,492.00	1740
54	DBFT54Z	POA	2600

Utility Pipe Fittings Fusion Bonded Epoxy

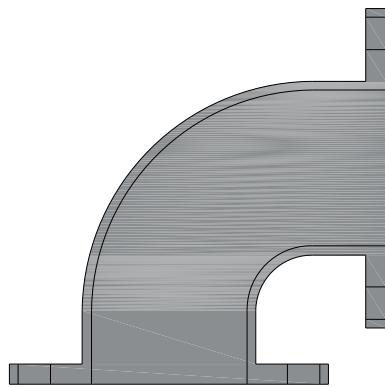

ANSI/AWWA C110/A21.10
FLANGE FITTINGS
FUSION BONDED EPOXY

PRICE LIST

Effective December 16, 2024



FLANGE BENDS
90° (1/4)

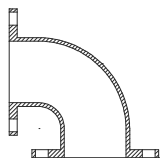

Size (in.)	Item No.	List Price (\$)	Wt. (lb.)
2	DFB9002E	201.00	14
3	DFB9003E	255.00	25
4	DFB9004E	358.00	45
6	DFB9006E	554.00	65
8	DFB9008E	909.00	105
10	DFB9010E	1,433.00	165
12	DFB9012E	2,026.00	235
14	DFB9014E	2,652.00	290
16	DFB9016E	3,284.00	370
18	DFB9018E	4,480.00	450
20	DFB9020E	5,499.00	580
24	DFB9024E	9,012.00	900
30	DFB9030E	15,474.00	1430
36	DFB9036E	21,023.00	2135
42	DFB9042E	38,586.00	3055
48	DFB9048E	51,693.00	4095
54	DFB9054E	POA	3740

FLANGE BENDS
45° (1/8)

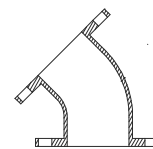

Size (in.)	Item No.	List Price (\$)	Wt. (lb.)
2	DFB4502E	207.00	12
3	DFB4503E	195.00	20
4	DFB4504E	346.00	40
6	DFB4506E	534.00	55
8	DFB4508E	820.00	90
10	DFB4510E	1,316.00	130
12	DFB4512E	1,713.00	195
14	DFB4514E	2,027.00	220
16	DFB4516E	2,575.00	280
18	DFB4518E	3,459.00	325
20	DFB4520E	4,636.00	430
24	DFB4524E	6,413.00	630
30	DFB4530E	13,394.00	1120
36	DFB4536E	20,985.00	1755
42	DFB4542E	32,819.00	2600
48	DFB4548E	45,190.00	3580
54	DFB4554E	POA	2735

FLANGE BENDS
22½° (1/16)

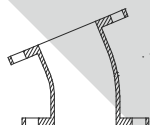

Size (in.)	Item No.	List Price (\$)	Wt. (lb.)
2	DFB2202E	273.00	12
3	DFB2203E	213.00	20
4	DFB2204E	345.00	40
6	DFB2206E	514.00	55
8	DFB2208E	799.00	90
10	DFB2210E	1,257.00	135
12	DFB2212E	1,838.00	205
14	DFB2214E	2,320.00	225
16	DFB2216E	2,661.00	285
18	DFB2218E	3,566.00	335
20	DFB2220E	4,914.00	435
24	DFB2224E	7,225.00	640
30	DFB2230E	13,573.00	1135
36	DFB2236E	21,403.00	1790
42	DFB2242E	33,644.00	2665
48	DFB2248E	46,266.00	3665
54	DFB2254E	POA	2260

FLANGE BENDS
11¼° (1/32)

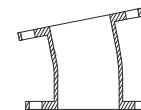

Size (in.)	Item No.	List Price (\$)	Wt. (lb.)
2	DFB1102E	273.00	12
3	DFB1103E	213.00	20
4	DFB1104E	401.00	40
6	DFB1106E	620.00	55
8	DFB1108E	846.00	90
10	DFB1110E	1,395.00	135
12	DFB1112E	2,117.00	205
14	DFB1114E	2,412.00	225
16	DFB1116E	2,939.00	285
18	DFB1118E	3,566.00	335
20	DFB1120E	4,914.00	435
24	DFB1124E	7,596.00	645
30	DFB1130E	13,754.00	1150
36	DFB1136E	21,583.00	1805
42	DFB1142E	33,832.00	2680
48	DFB1148E	46,644.00	3695
54	DFB1154E	POA	2100

CALL FOR BARE/BARE FITTINGS

90° LONG RADIUS BENDS

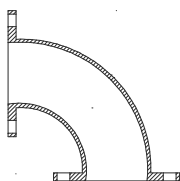

Size (in.)	Item No.	List Price (\$)	Wt. (lb.)
3	DFBLR9003E	317.00	30
4	DFBLR9004E	531.00	30
6	DFBLR9006E	912.00	80
8	DFBLR9008E	1,512.00	140
10	DFBLR9010E	2,217.00	215
12	DFBLR9012E	3,350.00	325
14	DFBLR9014E	3,965.00	580
16	DFBLR9016E	5,201.00	740
18	DFBLR9018E	6,693.00	840
20	DFBLR9020E	9,147.00	928
24	DFBLR9024E	13,999.00	1640
30	DFBLR9030E	25,169.00	2105
36	DFBLR9036E	39,274.00	3285
42	DFBLR9042E	61,413.00	4865
48	DFBLR9048E	85,706.00	7800
54	DFBLR9054E	POA	6205

90° FLANGE X FLARE BENDS

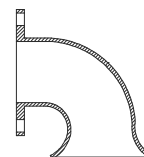

Size (in.)	Item No.	List Price (\$)	Wt. (lb.)
3	DFF9003E	267.00	25
4	DFF9004E	474.00	40
6	DFF9006E	726.00	70
8	DFF9008E	1,238.00	110
10	DFF9010E	2,014.00	175
12	DFF9012E	2,526.00	245
14	DFF9014E	3,500.00	340
16	DFF9016E	4,736.00	460
18	DFF9018E	5,952.00	560
20	DFF9020E	7,904.00	700
24	DFF9024E	11,437.00	1100
30	DFF9030E	23,555.00	1840
36	DFF9036E	32,636.00	2700
42	DFF9042E	40,393.00	3250
48	DFF9048E	66,080.00	4215
54	DFF9054E	POA	3965

STRAIGHT FLANGE X FLARE

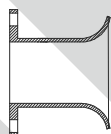

Size (in.)	Item No.	List Price (\$)	Wt. (lb.)
3	DFP03E	213.00	20
4	DFP04E	317.00	30
6	DFP06E	414.00	40
8	DFP08E	726.00	70
10	DFP10E	984.00	95
12	DFP12E	1,602.00	115
14	DFP14E	1,706.00	190
16	DFP16E	2,474.00	330
18	DFP18E	2,928.00	355
20	DFP20E	4,025.00	460
24	DFP24E	5,422.00	635
30	DFP30E	13,153.00	1025
36	DFP36E	17,456.00	1460
42	DFP42E	22,095.00	1900
48	DFP48E	29,982.00	2350
54	DFP54E	POA	2035

LONG RADIUS 90° FLANGE X FLARE BENDS

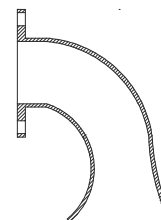

Size (in.)	Item No.	List Price (\$)	Wt. (lb.)
3	DFFLR9003E	365.00	30
4	DFFLR9004E	521.00	50
6	DFFLR9006E	931.00	90
8	DFFLR9008E	1,602.00	115
10	DFFLR9010E	2,579.00	250
12	DFFLR9012E	3,864.00	375
14	DFFLR9014E	5,147.00	500
16	DFFLR9016E	7,357.00	715
18	DFFLR9018E	8,497.00	800
20	DFFLR9020E	12,866.00	1140
24	DFFLR9024E	15,075.00	1335
30	DFFLR9030E	26,183.00	2190
36	DFFLR9036E	41,427.00	3465
42	DFFLR9042E	65,006.00	5150
48	DFFLR9048E	84,885.00	6725

CALL FOR BARE/BARE FITTINGS

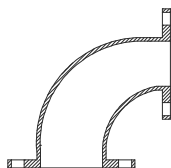
90° REDUCING BENDS

Size (in.)	Item No.	List Price (\$)	Wt. (lb.)
4 X 3	DFBR0403E	307.00	35
6 X 3	DFBR0603E	582.00	45
6 X 4	DFBR0604E	571.00	55
6 X 5	DFBR0605E	582.00	
8 X 4	DFBR0804E	779.00	80
8 X 6	DFBR0806E	886.00	90
10X 4	DFBR1004E	1,343.00	105
10X 6	DFBR1006E	1,395.00	125
10X 8	DFBR1008E	1,547.00	150
12X 4	DFBR1204E	1,445.00	
12X 6	DFBR1206E	1,651.00	165
12X 8	DFBR1208E	1,943.00	190
12X10	DFBR1210E	2,060.00	220
14X 6	DFBR1406E	1,961.00	144
14X 8	DFBR1408E	2,217.00	200
14X10	DFBR1410E	2,474.00	260
14X12	DFBR1412E	2,784.00	270
16X 6	DFBR1606E	2,268.00	220
16X 8	DFBR1608E	2,474.00	240
16X10	DFBR1610E	2,887.00	344
16X12	DFBR1612E	3,192.00	373
16X14	DFBR1614E	3,453.00	330
18X 6	DFBR1806E	2,766.00	260
18X 8	DFBR1808E	3,466.00	280
18X10	DFBR1810E	3,512.00	320
18X12	DFBR1812E	3,724.00	465
18X14	DFBR1814E	4,096.00	370
18X16	DFBR1816E	4,462.00	410
20X 6	DFBR2006E	3,618.00	320
20X 8	DFBR2008E	3,901.00	345
20X10	DFBR2010E	5,028.00	385
20X12	DFBR2012E	5,132.00	415
20X14	DFBR2014E	5,731.00	518
20X16	DFBR2016E	5,593.00	533
20X18	DFBR2018E	5,934.00	515
24X 6	DFBR2406E	5,422.00	480
24X 8	DFBR2408E	5,707.00	505
24X10	DFBR2410E	6,157.00	545
24X12	DFBR2412E	6,497.00	575
24X14	DFBR2414E	7,172.00	595

Size (in.)	Item No.	List Price (\$)	Wt. (lb.)
24X16	DFBR2416E	7,736.00	635
24X18	DFBR2418E	7,810.00	675
24X20	DFBR2420E	8,355.00	740
30X12	DFBR3012E	10,046.00	840
30X14	DFBR3014E	12,368.00	860
30X16	DFBR3016E	10,760.00	900
30X18	DFBR3018E	15,973.00	940
30X20	DFBR3020E	16,941.00	1005
30X24	DFBR3024E	14,411.00	1165
36X12	DFBR3612E	14,290.00	1195
36X14	DFBR3614E	18,289.00	1215
36X16	DFBR3616E	15,009.00	1255
36X18	DFBR3618E	19,344.00	1295
36X20	DFBR3620E	20,033.00	1315
36X24	DFBR3624E	18,954.00	1520
36X30	DFBR3630E	21,996.00	1785
42X12	DFBR4212E	POA	1655
42X14	DFBR4214E	25,407.00	1675
42X16	DFBR4216E	21,652.00	1715
42X18	DFBR4218E	28,628.00	1755
42X20	DFBR4220E	28,325.00	1820
42X24	DFBR4224E	24,999.00	1980
42X30	DFBR4230E	29,605.00	2245
42X36	DFBR4236E	42,793.00	2600
48X12	DFBR4812E	27,458.00	2175
48X14	DFBR4814E	32,868.00	2195
48X16	DFBR4816E	28,217.00	2235
48X18	DFBR4818E	39,749.00	2275
48X20	DFBR4820E	42,951.00	2340
48X24	DFBR4824E	40,899.00	2500
48X30	DFBR4830E	44,704.00	2765
48X36	DFBR4836E	44,974.00	3115
48X42	DFBR4842E	59,138.00	3580
54X12	DFBR5412E	POA	1990
54X14	DFBR5414E	POA	2015
54X16	DFBR5416E	POA	2055
54X18	DFBR5418E	POA	2095
54X20	DFBR5420E	POA	2160
54X24	DFBR5424E	POA	2320
54X30	DFBR5430E	POA	2585
54X36	DFBR5436E	POA	2940
54X42	DFBR5442E	POA	3395
54X48	DFBR5448E	POA	3565

CALL FOR BARE/BARE FITTINGS

90° BASE BENDS

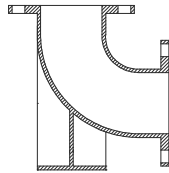

Size (in.)	Item No.	List Price (\$)	Wt. (lb.)
3	DFBB9003E	365.00	35
4	DFBB9004E	571.00	55
6	DFBB9006E	838.00	85
8	DFBB9008E	1,582.00	145
10	DFBB9010E	2,166.00	210
12	DFBB9012E	3,085.00	300
14	DFBB9014E	3,708.00	320
16	DFBB9016E	4,582.00	445
18	DFBB9018E	6,007.00	565
20	DFBB9020E	7,904.00	700
24	DFBB9024E	11,630.00	1030
30	DFBB9030E	19,431.00	1625
36	DFBB9036E	28,514.00	2385
42	DFBB9042E	52,780.00	3465
48	DFBB9048E	58,191.00	4610
54	DFBB9054E	POA	4415

90° LONG RADIUS BASE BENDS

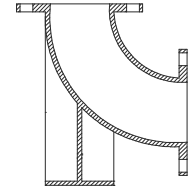

Size (in.)	Item No.	List Price (\$)	Wt. (lb.)
3	DFBBLR9003E	396.00	40
4	DFBBLR9004E	622.00	60
6	DFBBLR9006E	1,031.00	100
8	DFBBLR9008E	1,857.00	180
10	DFBBLR9010E	2,707.00	260
12	DFBBLR9012E	4,245.00	390
14	DFBBLR9014E	4,295.00	650
16	DFBBLR9016E	7,614.00	815
18	DFBBLR9018E	8,497.00	955
20	DFBBLR9020E	11,122.00	1200
24	DFBBLR9024E	16,140.00	1770
30	DFBBLR9030E	28,689.00	2295
36	DFBBLR9036E	43,991.00	3535
42	DFBBLR9042E	69,615.00	5275
48	DFBBLR9048E	96,370.00	7305
54	DFBBLR9054E	POA	6880

BASE TEES

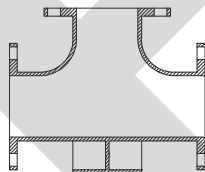

Size (in.)	Item No.	List Price (\$)	Wt. (lb.)
3	DFTB0303E	474.00	45
4	DFTB0404E	779.00	75
6	DFTB0606E	1,138.00	110
8	DFTB0808E	1,913.00	185
10	DFTB1010E	3,091.00	300
12	DFTB1212E	4,427.00	430
14	DFTB1414E	4,995.00	500
16	DFTB1616E	6,174.00	600
18	DFTB1818E	7,861.00	740
20	DFTB2020E	10,499.00	930
24	DFTB2424E	15,918.00	1410
30	DFTB3030E	27,141.00	2270
36	DFTB3636E	39,687.00	3320
42	DFTB4242E	73,840.00	5850
48	DFTB4848E	97,442.00	7720
54	DFTB5454E	POA	6465

CALL FOR BARE/BARE FITTINGS

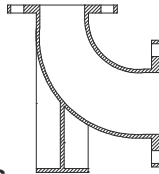
90° REDUCING BASE BENDS
 (WITH BASE UNDER SMALL END)

R - Available multiple size reductions.

Size (in.)	Item No.	List Price (\$)	Wt. (lb.)
4 X 3	DFBBSDR0403E	POA	45
6 X 4	DFBBSDR0604E	POA	75
8 X 4	DFBBSDR0804E	POA	120
8 X 6	DFBBSDR0806E	POA	130
10X 6	DFBBSDR1006E	POA	170
10X 8	DFBBSDR1008E	POA	195
12X 6	DFBBSDR1206E	POA	230
12X 8	DFBBSDR1208E	POA	255
12X10	DFBBSDR1210E	POA	285
14X R	DFBBSDR14E	POA	
16X R	DFBBSDR16E	POA	
18X R	DFBBSDR18E	POA	
20X R	DFBBSDR20E	POA	
24X R	DFBBSDR24E	POA	
30X R	DFBBSDR30E	POA	
36X R	DFBBSDR36E	POA	
42X R	DFBBSDR42E	POA	
48X R	DFBBSDR48E	POA	
54X R	DFBBSDR54E	POA	

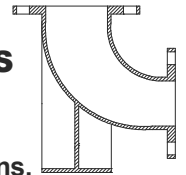
90° REDUCING BASE BENDS
 (WITH BASE UNDER LARGE END)

R - Available multiple size reductions.

Size (in.)	Item No.	List Price (\$)	Wt. (lb.)
4 X 3	DFBBLDR0403E	POA	45
6 X 4	DFBBLDR0604E	POA	75
8 X 4	DFBBLDR0804E	POA	120
8 X 6	DFBBLDR0806E	POA	130
10X 6	DFBBLDR1006E	POA	170
10X 8	DFBBLDR1008E	POA	195
12X 6	DFBBLDR1206E	POA	230
12X 8	DFBBLDR1208E	POA	255
12X10	DFBBLDR1210E	POA	285
14X R	DFBBLDR14E	POA	
16X R	DFBBLDR16E	POA	
18X R	DFBBLDR18E	POA	
20X R	DFBBLDR20E	POA	
24X R	DFBBLDR24E	POA	
30X R	DFBBLDR30E	POA	
36X R	DFBBLDR36E	POA	
42X R	DFBBLDR42E	POA	
48X R	DFBBLDR48E	POA	
54X R	DFBBLDR54E	POA	

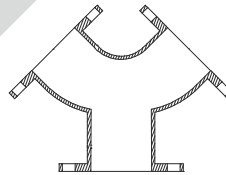
TRUE WYES

Size (in.)	Item No.	List Price (\$)	Wt. (lb.)
4 X 4 X 4	DFYT0404E	521.00	50
6 X 4 X 4	DFYT060404E	POA	75
6 X 6 X 6	DFYT0606E	829.00	80
8 X 6 X 6	DFYT080606E	POA	120
8 X 8 X 4	DFYT080804E	POA	
8 X 8 X 8	DFYT0808E	1,445.00	125
10 X 10 X 6	DFYT101006E	POA	
10 X 8 X 8	DFYT100808E	POA	155
10 X 10 X 10	DFYT101010E	1,913.00	185
12 X 12 X 6	DFYT121206E	POA	
12 X 12 X 8	DFYT121208E	POA	

Size (in.)	Item No.	List Price (\$)	Wt. (lb.)
12 X 12 X 10	DFYT121210E	POA	
12 X 12 X 12	DFYT1212E	3,091.00	300
14 X 14 X 14	DFYT1414E	4,273.00	415
16 X 16 X 16	DFYT1616E	5,973.00	580
18 X 18 X 18	DFYT1818E	7,224.00	680
20 X 20 X 20	DFYT2020E	10,839.00	960
24 X 24 X 24	DFYT2424E	15,466.00	1370
30 X 30 X 30	DFYT3030E	POA	80
36 X 36 X 36	DFYT3636E	POA	120
42 X 42 X 42	DFYT4242E	POA	125
48 X 48 X 48	DFYT4848E	POA	120

CALL FOR BARE/BARE FITTINGS

FLANGE TEES

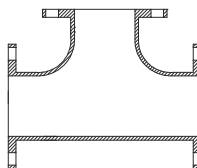

Size (in.)	Item No.	List Price (\$)	Wt. (lb.)
2 X 2	DFT0202E	252.00	20
3 X 2	DFT0302E	365.00	35
3 X 3	DFT0303E	361.00	40
4 X 2	DFT0402E	521.00	50
4 X 3	DFT0403E	622.00	60
4 X 4	DFT0404E	678.00	65
5 X 5	DFT0505E	886.00	80
6 X 2	DFT0602E	886.00	156
6 X 3	DFT0603E	931.00	85
6 X 4	DFT0604E	887.00	90
6 X 6	DFT0606E	1,427.00	95
8 X 3	DFT0803E	1,371.00	130
8 X 4	DFT0804E	1,275.00	140
8 X 6	DFT0806E	1,475.00	145
8 X 8	DFT0808E	POA	155
10X 4	DFT1004E	1,916.00	205
10X 6	DFT1006E	1,828.00	215
10X 8	DFT1008E	1,922.00	225
10X10	DFT1010E	2,232.00	270
12X 4	DFT1204E	2,620.00	290
12X 6	DFT1206E	2,548.00	295
12X 8	DFT1208E	2,686.00	310
12X10	DFT1210E	3,165.00	360
12X12	DFT1212E	3,231.00	385
14X 4	DFT1404E	POA	370
14X 6	DFT1406E	3,864.00	375
14X 8	DFT1408E	4,017.00	390
14X10	DFT1410E	4,117.00	400
14X12	DFT1412E	4,377.00	425
14X14	DFT1414E	4,481.00	435
16X 4	DFT1604E	POA	460
16X 6	DFT1606E	4,505.00	465
16X 8	DFT1608E	4,405.00	475
16X10	DFT1610E	5,065.00	495
16X12	DFT1612E	4,892.00	520
16X14	DFT1614E	5,458.00	530
16X16	DFT1616E	4,627.00	550
18X 6	DFT1806E	4,595.00	480
18X 8	DFT1808E	5,067.00	495
18X10	DFT1810E	5,421.00	510

Size (in.)	Item No.	List Price (\$)	Wt. (lb.)
18X12	DFT1812E	5,912.00	535
18X14	DFT1814E	6,587.00	630
18X16	DFT1816E	6,907.00	650
18X18	DFT1818E	6,441.00	785
20X 6	DFT2006E	6,891.00	610
20X 8	DFT2008E	7,002.00	620
20X10	DFT2010E	7,172.00	635
20X12	DFT2012E	7,453.00	660
20X14	DFT2014E	7,511.00	665
20X16	DFT2016E	9,147.00	810
20X18	DFT2018E	9,261.00	820
20X20	DFT2020E	8,150.00	855
24X 4	DFT2404E	9,544.00	
24X 6	DFT2406E	8,244.00	845
24X 8	DFT2408E	9,713.00	860
24X10	DFT2410E	9,936.00	880
24X12	DFT2412E	8,628.00	890
24X14	DFT2414E	10,087.00	900
24X16	DFT2416E	8,840.00	915
24X18	DFT2418E	13,773.00	1220
24X20	DFT2420E	14,170.00	1510
24X24	DFT2424E	12,897.00	1330
30X 6	DFT3006E	17,402.00	1450
30X 8	DFT3008E	17,456.00	
30X10	DFT3010E	17,816.00	
30X12	DFT3012E	17,816.00	1490
30X14	DFT3014E	17,816.00	1490
30X16	DFT3016E	17,997.00	1505
30X18	DFT3018E	18,117.00	1515
30X20	DFT3020E	18,411.00	1540
30X24	DFT3024E	24,212.00	2025
30X30	DFT3030E	22,444.00	2150
36X 6	DFT3606E	23,912.00	
36X 8	DFT3608E	25,706.00	
36X10	DFT3610E	25,767.00	3082
36X12	DFT3612E	25,945.00	2170
36X14	DFT3614E	26,006.00	2175
36X16	DFT3616E	26,126.00	2185
36X18	DFT3618E	26,183.00	2190

Contd.....

CALL FOR BARE/BARE FITTINGS

FLANGE TEES

Contd.....

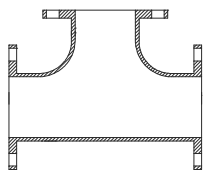

FLANGE TEES - BULL HEAD

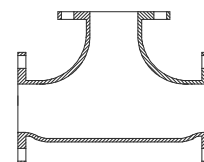

Size (in.)	Item No.	List Price (\$)	Wt. (lb.)
36X20	DFT3620E	26,423.00	2210
36X24	DFT3624E	26,961.00	2255
36X30	DFT3630E	35,862.00	3000
36X36	DFT3636E	33,348.00	3160
42X12	DFT4212E	39,953.00	3165
42X14	DFT4214E	40,016.00	3170
42X16	DFT4216E	40,142.00	3180
42X18	DFT4218E	40,204.00	3185
42X20	DFT4220E	40,461.00	3205
42X24	DFT4224E	40,964.00	3245
42X30	DFT4230E	52,070.00	4125
42X36	DFT4236E	67,657.00	5360
42X42	DFT4242E	70,434.00	5580
48X12	DFT4812E	54,470.00	4315
48X14	DFT4814E	54,470.00	4315
48X16	DFT4816E	54,657.00	4330
48X18	DFT4818E	54,657.00	4330
48X20	DFT4820E	54,908.00	4350
48X24	DFT4824E	55,349.00	4385
48X30	DFT4830E	56,237.00	4455
48X36	DFT4836E	70,119.00	7035
48X42	DFT4842E	90,817.00	7195
48X48	DFT4848E	93,216.00	7385
54X12	DFT5412E	POA	4435
54X14	DFT5414E	POA	4435
54X16	DFT5416E	POA	4450
54X18	DFT5418E	POA	4460
54X20	DFT5420E	POA	4480
54X24	DFT5424E	POA	4515
54X30	DFT5430E	POA	4615
54X36	DFT5436E	POA	4695
54X42	DFT5442E	POA	5740
54X48	DFT5448E	POA	5850
54X54	DFT5454E	POA	6025

Size (in.)	Item No.	List Price (\$)	Wt. (lb.)
4 X 4 X 6	DFTBH040406E	POA	90
6 X 6 X 8	DFTBH060608E	POA	140
8 X 8 X 10	DFTBH080810E	POA	260
8 X 8 X 12	DFTBH080812E	POA	291
10X10X12	DFTBH101012E	POA	355

FLANGE TEES - REDUCING ON THE RUN

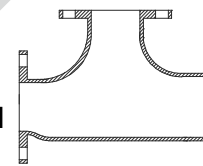

Size (in.)	Item No.	List Price (\$)	Wt. (lb.)
4 X 3 X 3	DFTROR040303E	POA	55
6 X 4 X 4	DFTROR060404E	931.00	103
6 X 4 X 6	DFTROR060406E	931.00	108
8 X 6 X 4	DFTROR080604E	1,458.00	146
8 X 6 X 6	DFTROR080606E	1,294.00	148
8 X 6 X 8	DFTROR080608E	1,498.00	145
10X 6 X 6	DFTROR100606E	3,002.00	275
10X 6 X 10	DFTROR100610E	2,954.00	305
10X 8 X 6	DFTROR100806E	3,019.00	280
10X 8 X 8	DFTROR100808E	3,186.00	302
10X 8 X 10	DFTROR100810E	3,268.00	325
12X 6 X 6	DFTROR120606E	3,732.00	340
12X 6 X 8	DFTROR120608E	3,906.00	360
12X 8 X 6	DFTROR120806E	3,828.00	355
12X 8 X 8	DFTROR120808E	4,045.00	375
12X 8 X 12	DFTROR120812E	4,529.00	420
12X10X 6	DFTROR121006E	3,738.00	390
12X10X 8	DFTROR121008E	4,312.00	400
12X10X10	DFTROR121010E	4,529.00	420
12X10X12	DFTROR121012E	4,743.00	440

CALL FOR BARE/BARE FITTINGS

FLANGE CROSS

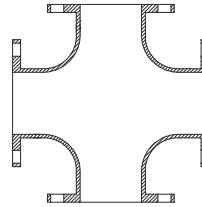

Size (in.)	Item No.	List Price (\$)	Wt. (lb.)
3 X 3	DFX0303E	521.00	50
4 X 3	DFX0403E	726.00	70
4 X 4	DFX0404E	748.00	80
6 X 3	DFX0603E	984.00	95
6 X 4	DFX0604E	1,138.00	110
6 X 6	DFX0606E	1,209.00	120
8 X 3	DFX0803E	POA	140
8 X 4	DFX0804E	1,602.00	155
8 X 6	DFX0806E	1,706.00	175
8 X 8	DFX0808E	1,808.00	195
10X 4	DFX1004E	2,268.00	220
10X 6	DFX1006E	2,474.00	240
10X 8	DFX1008E	2,733.00	265
10X10	DFX1010E	3,401.00	330
12X 4	DFX1204E	3,192.00	310
12X 6	DFX1206E	3,293.00	320
12X 8	DFX1208E	3,556.00	345
12X10	DFX1210E	4,273.00	415
12X12	DFX1212E	4,007.00	460
14X 6	DFX1406E	4,117.00	400
14X 8	DFX1408E	4,377.00	425
14X10	DFX1410E	4,736.00	460
14X12	DFX1412E	5,201.00	505
14X14	DFX1414E	5,458.00	530
16X 6	DFX1606E	5,045.00	490
16X 8	DFX1608E	5,353.00	520
16X10	DFX1610E	5,713.00	555
16X12	DFX1612E	6,231.00	605
16X14	DFX1614E	POA	620
16X16	DFX1616E	6,844.00	755
18X 6	DFX1806E	5,371.00	505
18X 8	DFX1808E	5,686.00	535
18X10	DFX1810E	5,952.00	560
18X12	DFX1812E	6,480.00	610
18X14	DFX1814E	7,648.00	720
18X16	DFX1816E	8,130.00	765
18X18	DFX1818E	8,450.00	795
20X 6	DFX2006E	7,172.00	635
20X 8	DFX2008E	7,511.00	665

Size (in.)	Item No.	List Price (\$)	Wt. (lb.)
20X10	DFX2010E	7,736.00	685
20X12	DFX2012E	8,301.00	735
20X14	DFX2014E	8,415.00	745
20X16	DFX2016E	10,332.00	915
20X18	DFX2018E	10,669.00	945
20X20	DFX2020E	11,461.00	1015
24X 6	DFX2406E	9,885.00	875
24X 8	DFX2408E	10,106.00	895
24X10	DFX2410E	10,499.00	930
24X12	DFX2412E	10,839.00	960
24X14	DFX2414E	11,010.00	975
24X16	DFX2416E	11,405.00	1010
24X18	DFX2418E	15,411.00	1365
24X20	DFX2420E	16,140.00	1430
24X24	DFX2424E	17,723.00	1570
30X10	DFX3010E	POA	
30X12	DFX3012E	18,715.00	1565
30X14	DFX3014E	18,774.00	1570
30X16	DFX3016E	19,195.00	1605
30X18	DFX3018E	19,310.00	1515
30X20	DFX3020E	19,968.00	1670
30X24	DFX3024E	26,844.00	2245
30X30	DFX3030E	29,888.00	2500
36X12	DFX3612E	26,780.00	2240
36X14	DFX3614E	26,780.00	2240
36X16	DFX3616E	27,141.00	2270
36X18	DFX3618E	27,259.00	2280
36X20	DFX3620E	27,797.00	2325
36X24	DFX3624E	28,754.00	2405
36X30	DFX3630E	39,449.00	3300
36X36	DFX3636E	43,275.00	3620
42X12	DFX4212E	40,899.00	3240
42X14	DFX4214E	40,899.00	3240
42X16	DFX4216E	41,279.00	3270
42X18	DFX4218E	41,341.00	3275
42X20	DFX4220E	41,911.00	3320
42X24	DFX4224E	42,858.00	4135
42X30	DFX4230E	55,224.00	4375
42X36	DFX4236E	72,199.00	5720

Contd.....

CALL FOR BARE/BARE FITTINGS

FLANGE CROSS

Contd.....

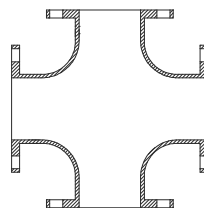

Size (in.)	Item No.	List Price (\$)	Wt. (lb.)
42X42	DFX4242E	77,694.00	6155
48X12	DFX4812E	55,414.00	4390
48X14	DFX4814E	55,349.00	4385
48X16	DFX4816E	55,733.00	4415
48X18	DFX4818E	55,791.00	4420
48X20	DFX4820E	56,297.00	4460
48X24	DFX4824E	57,246.00	4535
48X30	DFX4830E	58,946.00	5705
48X36	DFX4836E	74,218.00	7310
48X42	DFX4842E	96,308.00	7630
48X48	DFX4848E	1,01,042.00	8005

Size (in.)	Item No.	List Price (\$)	Wt. (lb.)
54X12	DFX5412E	POA	4575
54X14	DFX5414E	POA	4575
54X16	DFX5416E	POA	4605
54X18	DFX5418E	POA	4625
54X20	DFX5420E	POA	4665
54X24	DFX5424E	POA	4700
54X30	DFX5430E	POA	4800
54X36	DFX5436E	POA	4950
54X42	DFX5442E	POA	6210
54X48	DFX5448E	POA	6425
54X54	DFX5454E	POA	6780

FLANGE LATERAL WYES

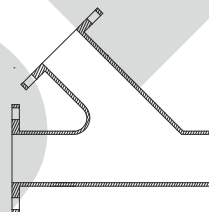

Size (in.)	Item No.	List Price (\$)	Wt. (lb.)
3 X 3	DFY0303E	474.00	45
4 X 2	DFY0402E	571.00	
4 X 3	DFY0403E	678.00	65
4 X 4	DFY0404E	659.00	75
6 X 3	DFY0603E	1,031.00	
6 X 4	DFY0604E	1,188.00	105
6 X 6	DFY0606E	1,054.00	120
8 X 4	DFY0804E	1,857.00	165
8 X 6	DFY0806E	1,794.00	175
8 X 8	DFY0808E	1,726.00	200
10X 4	DFY1004E	2,678.00	240
10X 6	DFY1006E	2,784.00	250
10X 8	DFY1008E	3,042.00	335
10X10	DFY1010E	2,756.00	335
12X 4	DFY1204E	3,913.00	350
12X 6	DFY1206E	4,070.00	427
12X 8	DFY1208E	4,017.00	452

Size (in.)	Item No.	List Price (\$)	Wt. (lb.)
12X10	DFY1210E	4,686.00	420
12X12	DFY1212E	4,201.00	515
14X 6	DFY1406E	5,353.00	475
14X 8	DFY1408E	5,612.00	500
14X10	DFY1410E	5,408.00	525
14X12	DFY1412E	6,379.00	570
14X14	DFY1414E	6,231.00	605
16X 6	DFY1606E	6,379.00	620
16X 8	DFY1608E	7,306.00	645
16X10	DFY1610E	7,614.00	675
16X12	DFY1612E	7,357.00	715
16X14	DFY1614E	8,541.00	755
16X16	DFY1616E	8,287.00	805
18X 6	DFY1806E	4,783.00	
18X 8	DFY1808E	6,644.00	780
18X10	DFY1810E	9,403.00	810
18X12	DFY1812E	9,879.00	850

Contd.....

CALL FOR BARE/BARE FITTINGS

FLANGE LATERAL WYES

Contd.....

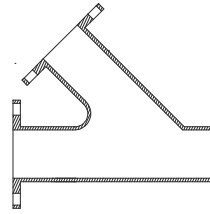

Size (in.)	Item No.	List Price (\$)	Wt. (lb.)
18X14	DFY1814E	10,358.00	885
18X16	DFY1816E	10,889.00	935
18X18	DFY1818E	10,411.00	1035
20X 8	DFY2008E	8,355.00	740
20X10	DFY2010E	9,093.00	1025
20X12	DFY2012E	12,536.00	1065
20X14	DFY2014E	13,720.00	1110
20X16	DFY2016E	14,337.00	1155
20X18	DFY2018E	13,548.00	1200
20X20	DFY2020E	14,284.00	1265
24X 6	DFY2406E	11,970.00	
24X 8	DFY2408E	12,192.00	1425
24X10	DFY2410E	16,991.00	1460
24X12	DFY2412E	13,548.00	1550
24X14	DFY2414E	19,752.00	1560
24X16	DFY2416E	21,332.00	1615
24X18	DFY2418E	20,944.00	1680
24X20	DFY2420E	19,752.00	1750
24X24	DFY2424E	21,505.00	1905
30X12	DFY3012E	33,416.00	2545
30X14	DFY3014E	34,075.00	2590
30X16	DFY3016E	34,730.00	2645
30X18	DFY3018E	35,385.00	2690
30X20	DFY3020E	36,340.00	2760
30X24	DFY3024E	38,316.00	2915
30X30	DFY3030E	38,557.00	3225
36X12	DFY3612E	53,676.00	4490
36X14	DFY3614E	54,333.00	4545
36X16	DFY3616E	53,260.00	4000
36X18	DFY3618E	55,827.00	4670

Size (in.)	Item No.	List Price (\$)	Wt. (lb.)
36X20	DFY3620E	54,692.00	4750
36X24	DFY3624E	56,486.00	4920
36X30	DFY3630E	62,158.00	5255
36X36	DFY3636E	68,612.00	5740
42X12	DFY4212E	72,263.00	5725
42X14	DFY4214E	73,210.00	5800
42X16	DFY4216E	73,840.00	5850
42X18	DFY4218E	75,735.00	6000
42X20	DFY4220E	77,124.00	6680
42X24	DFY4224E	78,956.00	6850
42X30	DFY4230E	86,528.00	7185
42X36	DFY4236E	96,562.00	7670
42X42	DFY4242E	1,15,745.00	9185
48X12	DFY4812E	90,881.00	7200
48X14	DFY4814E	91,829.00	7276
48X16	DFY4816E	93,404.00	7400
48X18	DFY4818E	96,180.00	7620
48X20	DFY4820E	97,001.00	7685
48X24	DFY4824E	86,336.00	8695
48X30	DFY4830E	1,01,168.00	5573
48X36	DFY4836E	1,13,218.00	9515
48X42	DFY4842E	1,38,968.00	11030
48X48	DFY4848E	1,52,722.00	12115
54X24	DFY5424E	POA	6220
54X30	DFY5430E	POA	7478
54X36	DFY5436E	POA	7600
54X42	DFY5442E	POA	8930
54X48	DFY5448E	POA	9480
54X54	DFY5454E	POA	11780
60X30	DFY6030E	POA	9045

CALL FOR BARE/BARE FITTINGS

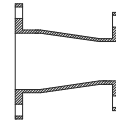
CONCENTRIC REDUCER

Size (in.)	Item No.	List Price (\$)	Wt. (lb.)
3 X 2	DFCR0302E	173.00	16
4 X 2	DFCR0402E	267.00	25
4 X 2.5	DFCR0402.5E	268.00	26
4 X 3	DFCR0403E	365.00	30
6 X 2	DFCR0602E	414.00	35
6 X 3	DFCR0603E	415.00	40
6 X 4	DFCR0604E	528.00	45
6 X 5	DFCR0605E	POA	52
8 X 3	DFCR0803E	625.00	60
8 X 4	DFCR0804E	726.00	65
8 X 5	DFCR0805E	679.00	70
8 X 6	DFCR0806E	886.00	75
10X 4	DFCR1004E	880.00	85
10X 6	DFCR1006E	1,102.00	90
10X 8	DFCR1008E	1,238.00	110
12X 4	DFCR1204E	1,298.00	120
12X 6	DFCR1206E	1,451.00	130
12X 8	DFCR1208E	1,645.00	145
12X10	DFCR1210E	1,602.00	170
14X 6	DFCR1406E	1,807.00	155
14X 8	DFCR1408E	1,989.00	175
14X10	DFCR1410E	1,942.00	190
14X12	DFCR1412E	1,961.00	248
16X 6	DFCR1606E	1,854.00	190
16X 8	DFCR1608E	2,084.00	210
16X10	DFCR1610E	2,674.00	235
16X12	DFCR1612E	2,887.00	265
16X14	DFCR1614E	2,554.00	280
18X 8	DFCR1808E	2,821.00	240
18X10	DFCR1810E	2,828.00	265
18X12	DFCR1812E	3,298.00	295
18X14	DFCR1814E	3,271.00	310
18X16	DFCR1816E	3,392.00	340
20X 6	DFCR2006E	3,224.00	

Size (in.)	Item No.	List Price (\$)	Wt. (lb.)
20X 8	DFCR2008E	3,506.00	
20X10	DFCR2010E	3,480.00	310
20X12	DFCR2012E	4,017.00	345
20X14	DFCR2014E	3,736.00	355
20X16	DFCR2016E	4,636.00	390
20X18	DFCR2018E	4,631.00	410
24X 8	DFCR2408E	5,310.00	410
24X10	DFCR2410E	5,767.00	
24X12	DFCR2412E	5,921.00	480
24X14	DFCR2414E	5,163.00	490
24X16	DFCR2416E	6,210.00	525
24X18	DFCR2418E	6,666.00	550
24X20	DFCR2420E	9,212.00	590
30X12	DFCR3012E	9,327.00	825
30X16	DFCR3016E	9,690.00	770
30X18	DFCR3018E	10,406.00	810
30X20	DFCR3020E	11,602.00	870
30X24	DFCR3024E	13,215.00	970
36X16	DFCR3616E	13,874.00	1105
36X18	DFCR3618E	14,707.00	
36X20	DFCR3620E	16,086.00	1230
36X24	DFCR3624E	18,595.00	1345
36X30	DFCR3630E	22,976.00	1555
42X24	DFCR4224E	26,002.00	1820
42X30	DFCR4230E	29,605.00	2060
42X36	DFCR4236E	29,476.00	2550
48X30	DFCR4830E	33,137.00	2625
48X36	DFCR4836E	37,239.00	2950
48X42	DFCR4842E	41,911.00	3320
54X30	DFCR5430E	POA	1625
54X36	DFCR5436E	POA	1680
54X42	DFCR5442E	POA	1800
54X48	DFCR5448E	POA	1695

CALL FOR BARE/BARE FITTINGS

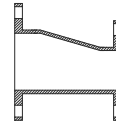
ECCENTRIC REDUCER

Size (in.)	Item No.	List Price (\$)	Wt. (lb.)
3 X 2	DFER0302E	173.00	16
4 X 2	DFER0402E	267.00	25
4 X 3	DFER0403E	317.00	30
6 X 2	DFER0602E	POA	35
6 X 3	DFER0603E	414.00	40
6 X 4	DFER0604E	474.00	45
6 X 5	DFER0605E	543.00	52
8 X 3	DFER0803E	POA	60
8 X 4	DFER0804E	678.00	65
8 X 5	DFER0805E	726.00	70
8 X 6	DFER0806E	779.00	75
10X 4	DFER1004E	886.00	85
10X 6	DFER1006E	931.00	90
10X 8	DFER1008E	1,138.00	110
12X 4	DFER1204E	1,238.00	120
12X 6	DFER1206E	1,343.00	130
12X 8	DFER1208E	1,498.00	145
12X10	DFER1210E	1,757.00	170
14X 6	DFER1406E	1,602.00	155
14X 8	DFER1408E	1,757.00	175
14X10	DFER1410E	1,961.00	190
14X12	DFER1412E	2,320.00	248
16X 6	DFER1606E	1,961.00	190
16X 8	DFER1608E	2,166.00	210
16X10	DFER1610E	2,424.00	235
16X12	DFER1612E	2,733.00	265
16X14	DFER1614E	2,887.00	280
18X 8	DFER1808E	2,554.00	240
18X10	DFER1810E	2,821.00	265
18X12	DFER1812E	3,142.00	295
18X14	DFER1814E	3,298.00	310
18X16	DFER1816E	3,614.00	340
20X 8	DFER2008E	3,277.00	
20X10	DFER2010E	3,506.00	310

Size (in.)	Item No.	List Price (\$)	Wt. (lb.)
20X12	DFER2012E	3,901.00	345
20X14	DFER2014E	4,017.00	355
20X16	DFER2016E	4,406.00	390
20X18	DFER2018E	4,631.00	410
24X 8	DFER2408E	5,196.00	
24X10	DFER2410E	5,310.00	
24X12	DFER2412E	5,422.00	480
24X14	DFER2414E	5,535.00	490
24X16	DFER2416E	5,934.00	525
24X18	DFER2418E	6,210.00	550
24X20	DFER2420E	6,666.00	590
30X10	DFER3010E	9,044.00	
30X14	DFER3014E	11,602.00	825
30X16	DFER3016E	11,185.00	770
30X18	DFER3018E	9,747.00	810
30X20	DFER3020E	10,406.00	870
30X24	DFER3024E	11,602.00	970
36X14	DFER3614E	15,426.00	1290
36X16	DFER3616E	13,335.00	1105
36X18	DFER3618E	13,874.00	
36X20	DFER3620E	14,650.00	1230
36X24	DFER3624E	16,021.00	1345
36X30	DFER3630E	18,535.00	1555
42X24	DFER4224E	22,976.00	1820
42X30	DFER4230E	26,002.00	2060
42X36	DFER4236E	29,605.00	2550
48X24	DFER4824E	31,551.00	
48X30	DFER4830E	33,137.00	2625
48X36	DFER4836E	37,239.00	2950
48X42	DFER4842E	41,911.00	3320
54X30	DFER5430E	POA	1625
54X36	DFER5436E	POA	1680
54X42	DFER5442E	POA	1800
54X48	DFER5448E	POA	1695

CALL FOR BARE/BARE FITTINGS

BLIND FLANGES

Size (in.)	Item No.	List Price (\$)	Wt. (lb.)
2	DBF02E	POA	9
3	DBF03E	101.00	9
4	DBF04E	174.00	16
6	DBF06E	264.00	25
8	DBF08E	439.00	42
10	DBF10E	656.00	63
12	DBF12E	880.00	85
14	DBF14E	1,237.00	120
16	DBF16E	1,498.00	145
18	DBF18E	2,074.00	195
20	DBF20E	2,766.00	245
24	DBF24E	4,113.00	370
30	DBF30E	5,974.00	500
36	DBF36E	11,460.00	960
42	DBF42E	16,382.00	1300
48	DBF48E	21,925.00	1740
54	DBF54E	POA	2600

**2" TAPPED
BLIND FLANGES**

Size (in.)	Item No.	List Price (\$)	Wt. (lb.)
3	DBFT03E	167.00	9
4	DBFT04E	238.00	16
6	DBFT06E	327.00	25
8	DBFT08E	501.00	42
10	DBFT10E	720.00	63
12	DBFT12E	946.00	85
14	DBFT14E	1,341.00	120
16	DBFT16E	1,605.00	145
18	DBFT18E	2,209.00	195
20	DBFT20E	2,900.00	245
24	DBFT24E	4,248.00	370
30	DBFT30E	6,174.00	500
36	DBFT36E	11,661.00	960
42	DBFT42E	16,648.00	1300
48	DBFT48E	22,191.00	1740
54	DBFT54E	POA	2600

CALL FOR BARE/BARE FITTINGS

Utility Pipe Fittings P401 Lined

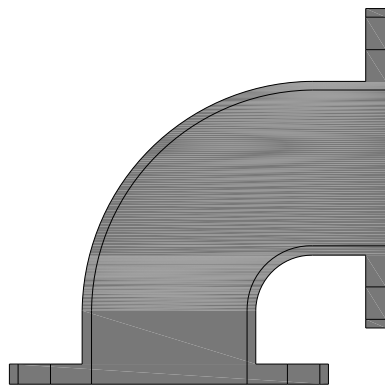

ANSI/AWWA C110/A21.10
FLANGE FITTINGS
P401 LINED

PRICE LIST

Effective **December 16, 2024**



FLANGE BENDS
90° (1/4)

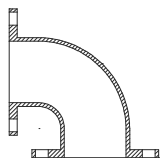

Size (in.)	Item No.	List Price (\$)	Wt. (lb.)
2	DFB9002P401	POA	14
3	DFB9003P401	700.00	25
4	DFB9004P401	700.00	45
6	DFB9006P401	1,072.00	65
8	DFB9008P401	1,623.00	105
10	DFB9010P401	2,378.00	165
12	DFB9012P401	3,027.00	235
14	DFB9014P401	3,786.00	290
16	DFB9016P401	4,646.00	370
18	DFB9018P401	6,055.00	450
20	DFB9020P401	7,369.00	580
24	DFB9024P401	11,348.00	900
30	DFB9030P401	17,894.00	1430
36	DFB9036P401	27,104.00	2135
42	DFB9042P401	47,298.00	3055
48	DFB9048P401	62,769.00	4095
54	DFB9054P401	POA	3740

FLANGE BENDS
45° (1/8)

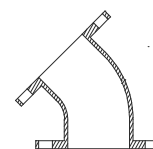

Size (in.)	Item No.	List Price (\$)	Wt. (lb.)
2	DFB4502P401	POA	12
3	DFB4503P401	654.00	20
4	DFB4504P401	654.00	40
6	DFB4506P401	997.00	55
8	DFB4508P401	1,442.00	90
10	DFB4510P401	2,116.00	130
12	DFB4512P401	2,688.00	195
14	DFB4514P401	3,173.00	220
16	DFB4516P401	3,897.00	280
18	DFB4518P401	5,175.00	325
20	DFB4520P401	6,507.00	430
24	DFB4524P401	8,742.00	630
30	DFB4530P401	17,430.00	1120
36	DFB4536P401	26,484.00	1755
42	DFB4542P401	40,725.00	2600
48	DFB4548P401	55,334.00	3580
54	DFB4554P401	POA	2735

FLANGE BENDS
22½° (1/16)

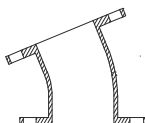

Size (in.)	Item No.	List Price (\$)	Wt. (lb.)
2	DFB2202P401	POA	12
3	DFB2203P401	653.00	20
4	DFB2204P401	653.00	40
6	DFB2206P401	973.00	55
8	DFB2208P401	1,427.00	90
10	DFB2210P401	2,056.00	135
12	DFB2212P401	2,824.00	205
14	DFB2214P401	3,587.00	225
16	DFB2216P401	3,993.00	285
18	DFB2218P401	5,292.00	335
20	DFB2220P401	7,011.00	435
24	DFB2224P401	9,901.00	640
30	DFB2230P401	17,634.00	1135
36	DFB2236P401	26,956.00	1790
42	DFB2242P401	41,664.00	2665
48	DFB2248P401	56,560.00	3665
54	DFB2254P401	POA	2260

FLANGE BENDS
11¼° (1/32)

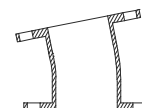

Size (in.)	Item No.	List Price (\$)	Wt. (lb.)
2	DFB1102P401	POA	12
3	DFB1103P401	731.00	20
4	DFB1104P401	731.00	40
6	DFB1106P401	1,117.00	55
8	DFB1108P401	1,485.00	90
10	DFB1110P401	2,266.00	135
12	DFB1112P401	3,212.00	205
14	DFB1114P401	3,685.00	225
16	DFB1116P401	4,413.00	285
18	DFB1118P401	5,292.00	335
20	DFB1120P401	7,011.00	435
24	DFB1124P401	10,313.00	645
30	DFB1130P401	17,836.00	1150
36	DFB1136P401	27,162.00	1805
42	DFB1142P401	41,880.00	2680
48	DFB1148P401	56,995.00	3695
54	DFB1154P401	POA	2100

90° LONG RADIUS BENDS

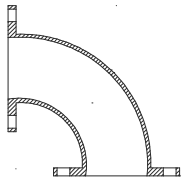

Size (in.)	Item No.	List Price (\$)	Wt. (lb.)
3	DFBLR9003P401	866.00	30
4	DFBLR9004P401	866.00	30
6	DFBLR9006P401	1,433.00	80
8	DFBLR9008P401	2,241.00	140
10	DFBLR9010P401	3,175.00	215
12	DFBLR9012P401	4,575.00	325
14	DFBLR9014P401	5,408.00	580
16	DFBLR9016P401	6,913.00	740
18	DFBLR9018P401	8,756.00	840
20	DFBLR9020P401	11,751.00	928
24	DFBLR9024P401	17,486.00	1640
30	DFBLR9030P401	30,773.00	2105
36	DFBLR9036P401	47,203.00	3285
42	DFBLR9042P401	73,443.00	4865
48	DFBLR9048P401	1,01,701.00	7800
54	DFBLR9054P401	POA	6205

90° FLANGE X FLARE BENDS

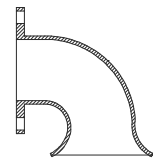

Size (in.)	Item No.	List Price (\$)	Wt. (lb.)
3	DFF9003P401	702.00	25
4	DFF9004P401	807.00	40
6	DFF9006P401	1,238.00	70
8	DFF9008P401	1,954.00	110
10	DFF9010P401	2,950.00	175
12	DFF9012P401	3,667.00	245
14	DFF9014P401	4,892.00	340
16	DFF9016P401	6,400.00	460
18	DFF9018P401	7,935.00	560
20	DFF9020P401	10,358.00	700
24	DFF9024P401	14,390.00	1100
30	DFF9030P401	28,945.00	1840
36	DFF9036P401	39,687.00	2700
42	DFF9042P401	49,390.00	3250
48	DFF9048P401	79,239.00	4215
54	DFF9054P401	POA	3965

STRAIGHT FLANGE X FLARE

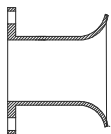

Size (in.)	Item No.	List Price (\$)	Wt. (lb.)
3	DFP03P401	POA	20
4	DFP04P401	638.00	30
6	DFP06P401	895.00	40
8	DFP08P401	1,388.00	70
10	DFP10P401	1,814.00	95
12	DFP12P401	2,643.00	115
14	DFP14P401	2,906.00	190
16	DFP16P401	3,897.00	330
18	DFP18P401	4,590.00	355
20	DFP20P401	6,014.00	460
24	DFP24P401	7,880.00	635
30	DFP30P401	17,522.00	1025
36	DFP36P401	POA	1460
42	DFP42P401	POA	1900
48	DFP48P401	POA	2350
54	DFP54P401	POA	2035

LONG RADIUS 90° FLANGE X FLARE BENDS

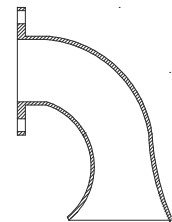

Size (in.)	Item No.	List Price (\$)	Wt. (lb.)
3	DFFLR9003P401	POA	30
4	DFFLR9004P401	POA	50
6	DFFLR9006P401	2,282.00	90
8	DFFLR9008P401	3,680.00	115
10	DFFLR9010P401	5,644.00	250
12	DFFLR9012P401	8,161.00	375
14	DFFLR9014P401	10,675.00	500
16	DFFLR9016P401	14,870.00	715
18	DFFLR9018P401	17,186.00	800
20	DFFLR9020P401	25,586.00	1140
24	DFFLR9024P401	30,025.00	1335
30	DFFLR9030P401	51,512.00	2190
36	DFFLR9036P401	80,310.00	3465
42	DFFLR9042P401	79,667.00	5150
48	DFFLR9048P401	1,03,391.00	6725

P401

P401

P401

P401

P401

P401

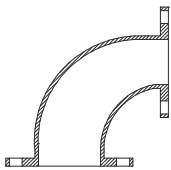
90° REDUCING BENDS

Size (in.)	Item No.	List Price (\$)	Wt. (lb.)
4 X 3	DFBR0403P401	625.00	35
6 X 3	DFBR0603P401	1,080.00	45
6 X 4	DFBR0604P401	1,068.00	55
6 X 5	DFBR0605P401	POA	
8 X 4	DFBR0804P401	1,442.00	80
8 X 6	DFBR0806P401	1,556.00	90
10X 4	DFBR1004P401	2,252.00	105
10X 6	DFBR1006P401	2,266.00	125
10X 8	DFBR1008P401	2,439.00	150
12X 4	DFBR1204P401	POA	
12X 6	DFBR1206P401	2,697.00	165
12X 8	DFBR1208P401	3,039.00	190
12X10	DFBR1210P401	3,153.00	220
14X 6	DFBR1406P401	3,186.00	144
14X 8	DFBR1408P401	3,475.00	200
14X10	DFBR1410P401	3,754.00	260
14X12	DFBR1412P401	4,097.00	270
16X 6	DFBR1606P401	POA	220
16X 8	DFBR1608P401	3,897.00	240
16X10	DFBR1610P401	4,352.00	344
16X12	DFBR1612P401	4,699.00	373
16X14	DFBR1614P401	4,978.00	330
18X 6	DFBR1806P401	POA	260
18X 8	DFBR1808P401	POA	280
18X10	DFBR1810P401	5,235.00	320
18X12	DFBR1812P401	5,471.00	465
18X14	DFBR1814P401	5,882.00	370
18X16	DFBR1816P401	6,290.00	410
20X 6	DFBR2006P401	POA	320
20X 8	DFBR2008P401	POA	345
20X10	DFBR2010P401	POA	385
20X12	DFBR2012P401	7,353.00	415
20X14	DFBR2014P401	8,060.00	518
20X16	DFBR2016P401	7,769.00	533
20X18	DFBR2018P401	8,147.00	515
24X 6	DFBR2406P401	POA	480
24X 8	DFBR2408P401	POA	505
24X10	DFBR2410P401	POA	545
24X12	DFBR2412P401	9,083.00	575
24X14	DFBR2414P401	9,840.00	595
24X16	DFBR2416P401	10,474.00	635

Size (in.)	Item No.	List Price (\$)	Wt. (lb.)
24X18	DFBR2418P401	10,599.00	675
24X20	DFBR2420P401	11,165.00	740
30X12	DFBR3012P401	13,637.00	840
30X14	DFBR3014P401	25,911.00	860
30X16	DFBR3016P401	14,451.00	900
30X18	DFBR3018P401	25,180.00	940
30X20	DFBR3020P401	26,931.00	1005
30X24	DFBR3024P401	18,584.00	1165
36X12	DFBR3612P401	17,336.00	1195
36X14	DFBR3614P401	23,057.00	1215
36X16	DFBR3616P401	18,206.00	1255
36X18	DFBR3618P401	24,364.00	1295
36X20	DFBR3620P401	25,178.00	1315
36X24	DFBR3624P401	24,180.00	1520
36X30	DFBR3630P401	27,634.00	1785
42X12	DFBR4212P401	POA	1655
42X14	DFBR4214P401	32,069.00	1675
42X16	DFBR4216P401	26,533.00	1715
42X18	DFBR4218P401	36,507.00	1755
42X20	DFBR4220P401	35,675.00	1820
42X24	DFBR4224P401	30,636.00	1980
42X30	DFBR4230P401	37,039.00	2245
42X36	DFBR4236P401	53,624.00	2600
48X12	DFBR4812P401	34,405.00	2175
48X14	DFBR4814P401	42,343.00	2195
48X16	DFBR4816P401	35,354.00	2235
48X18	DFBR4818P401	52,288.00	2275
48X20	DFBR4820P401	56,839.00	2340
48X24	DFBR4824P401	49,980.00	2500
48X30	DFBR4830P401	55,679.00	2765
48X36	DFBR4836P401	57,228.00	3115
48X42	DFBR4842P401	67,730.00	3580
54X12	DFBR5412P401	POA	1990
54X14	DFBR5414P401	POA	2015
54X16	DFBR5416P401	POA	2055
54X18	DFBR5418P401	POA	2095
54X20	DFBR5420P401	POA	2160
54X24	DFBR5424P401	POA	2320
54X30	DFBR5430P401	POA	2585
54X36	DFBR5436P401	POA	2940
54X42	DFBR5442P401	POA	3395
54X48	DFBR5448P401	POA	3565

90° BASE BENDS

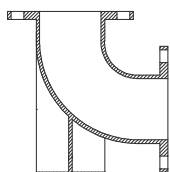

Size (in.)	Item No.	List Price (\$)	Wt. (lb.)
3	DFBB9003P401	921.00	35
4	DFBB9004P401	921.00	55
6	DFBB9006P401	1,327.00	85
8	DFBB9008P401	2,315.00	145
10	DFBB9010P401	3,120.00	210
12	DFBB9012P401	4,276.00	300
14	DFBB9014P401	5,120.00	320
16	DFBB9016P401	6,231.00	445
18	DFBB9018P401	7,996.00	565
20	DFBB9020P401	10,358.00	700
24	DFBB9024P401	14,831.00	1030
30	DFBB9030P401	24,270.00	1625
36	DFBB9036P401	35,015.00	2385
42	DFBB9042P401	62,766.00	3465
48	DFBB9048P401	70,210.00	4610
54	DFBB9054P401	POA	4415

90° LONG RADIUS BASE BENDS

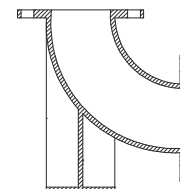

Size (in.)	Item No.	List Price (\$)	Wt. (lb.)
3	DFBBLR9003P401	672.00	40
4	DFBBLR9004P401	977.00	60
6	DFBBLR9006P401	1,580.00	100
8	DFBBLR9008P401	2,636.00	180
10	DFBBLR9010P401	3,691.00	260
12	DFBBLR9012P401	5,622.00	390
14	DFBBLR9014P401	5,770.00	650
16	DFBBLR9016P401	9,582.00	815
18	DFBBLR9018P401	10,749.00	955
20	DFBBLR9020P401	13,963.00	1200
24	DFBBLR9024P401	19,886.00	1770
30	DFBBLR9030P401	34,764.00	2295
36	DFBBLR9036P401	52,553.00	3535
42	DFBBLR9042P401	88,491.00	5275
48	DFBBLR9048P401	1,21,810.00	7305
54	DFBBLR9054P401	POA	6880

BASE TEES

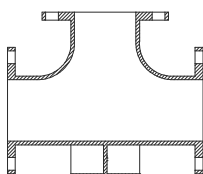

Size (in.)	Item No.	List Price (\$)	Wt. (lb.)
3	DFTB0303P401	755.00	45
4	DFTB0404P401	1,151.00	75
6	DFTB0606P401	1,697.00	110
8	DFTB0808P401	2,695.00	185
10	DFTB1010P401	4,143.00	300
12	DFTB1212P401	5,770.00	430
14	DFTB1414P401	6,543.00	500
16	DFTB1616P401	7,991.00	600
18	DFTB1818P401	10,044.00	740
20	DFTB2020P401	13,268.00	930
24	DFTB2424P401	19,635.00	1410
30	DFTB3030P401	33,005.00	2270
36	DFTB3636P401	47,674.00	3320
42	DFTB4242P401	93,689.00	5850
48	DFTB4848P401	1,23,132.00	7720
54	DFTB5454P401	POA	6465

P401

P401

P401

P401

P401

P401

90° REDUCING BASE BENDS

(WITH BASE UNDER SMALL END)

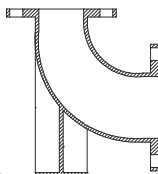

R - Available multiple size reductions.

Size (in.)	Item No.	List Price (\$)	Wt. (lb.)
4 X 3	DFBBSDR0403P401	POA	45
6 X 4	DFBBSDR0604P401	POA	75
8 X 4	DFBBSDR0804P401	POA	120
8 X 6	DFBBSDR0806P401	POA	130
10X 6	DFBBSDR1006P401	POA	170
10X 8	DFBBSDR1008P401	POA	195
12X 6	DFBBSDR1206P401	POA	230
12X 8	DFBBSDR1208P401	POA	255
12X10	DFBBSDR1210P401	POA	285
14X R	DFBBSDR14P401	POA	
16X R	DFBBSDR16P401	POA	
18X R	DFBBSDR18P401	POA	
20X R	DFBBSDR20P401	POA	
24X R	DFBBSDR24P401	POA	
30X R	DFBBSDR30P401	POA	
36X R	DFBBSDR36P401	POA	
42X R	DFBBSDR42P401	POA	
48X R	DFBBSDR48P401	POA	
54X R	DFBBSDR54P401	POA	

90° REDUCING BASE BENDS

(WITH BASE UNDER LARGE END)

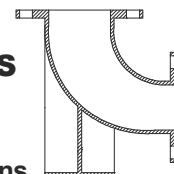

R - Available multiple size reductions.

Size (in.)	Item No.	List Price (\$)	Wt. (lb.)
4 X 3	DFBBLDR0403P401	POA	45
6 X 4	DFBBLDR0604P401	POA	75
8 X 4	DFBBLDR0804P401	POA	120
8 X 6	DFBBLDR0806P401	POA	130
10X 6	DFBBLDR1006P401	POA	170
10X 8	DFBBLDR1008P401	POA	195
12X 6	DFBBLDR1206P401	POA	230
12X 8	DFBBLDR1208P401	POA	255
12X10	DFBBLDR1210P401	POA	285
14X R	DFBBLDR14P401	POA	
16X R	DFBBLDR16P401	POA	
18X R	DFBBLDR18P401	POA	
20X R	DFBBLDR20P401	POA	
24X R	DFBBLDR24P401	POA	
30X R	DFBBLDR30P401	POA	
36X R	DFBBLDR36P401	POA	
42X R	DFBBLDR42P401	POA	
48X R	DFBBLDR48P401	POA	
54X R	DFBBLDR54P401	POA	

TRUE WYES

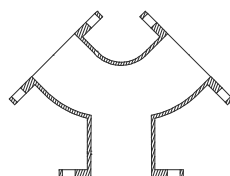

Size (in.)	Item No.	List Price (\$)	Wt. (lb.)
4 X 4 X 4	DFYT040404P401	866.00	50
6 X 4 X 4	DFYT060404P401	1,078.00	75
6 X 6 X 6	DFYT060606P401	1,353.00	80
8 X 4 X 4	DFYT080404P401	1,523.00	
8 X 6 X 6	DFYT080606P401	1,658.00	120
8 X 8 X 8	DFYT080808P401	2,183.00	125
10 X 6 X 6	DFYT100606P401	2,296.00	
10 X 8 X 8	DFYT100808P401	2,558.00	155
10 X 10 X 10	DFYT101010P401	3,036.00	185
12 X 6 X 6	DFYT12606P401	POA	
12 X 8 X 8	DFYT12808P401	3,360.00	210

Size (in.)	Item No.	List Price (\$)	Wt. (lb.)
12 X 10 X 10	DFYT121010P401	3,840.00	240
12 X 12 X 12	DFYT121212P401	4,798.00	300
14 X 14 X 14	DFYT141414P401	POA	415
16 X 16 X 16	DFYT161616P401	POA	580
18 X 18 X 18	DFYT181818P401	POA	680
20 X 20 X 20	DFYT202020P401	POA	960
24 X 24 X 24	DFYT242424P401	POA	1370
30 X 30 X 30	DFYT303030P401	POA	80
36 X 36 X 36	DFYT363636P401	POA	120
42 X 42 X 42	DFYT424242P401	POA	125
48 X 48 X 48	DFYT484848P401	POA	120

FLANGE TEES

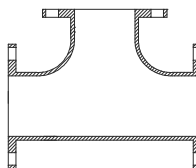

Size (in.)	Item No.	List Price (\$)	Wt. (lb.)
2 X 2	DFT0202P401	POA	20
3 X 2	DFT0302P401	POA	35
3 X 3	DFT0303P401	1,036.00	40
4 X 2	DFT0402P401	POA	50
4 X 3	DFT0403P401	1,002.00	60
4 X 4	DFT0404P401	1,036.00	65
5 X 5	DFT0505P401	POA	80
6 X 2	DFT0602P401	POA	156
6 X 3	DFT0603P401	1,444.00	85
6 X 4	DFT0604P401	1,467.00	90
6 X 6	DFT0606P401	1,365.00	95
8 X 3	DFT0803P401	2,217.00	130
8 X 4	DFT0804P401	2,025.00	140
8 X 6	DFT0806P401	1,929.00	145
8 X 8	DFT0808P401	2,134.00	155
10 X 4	DFT1004P401	2,800.00	205
10 X 6	DFT1006P401	2,658.00	215
10 X 8	DFT1008P401	2,756.00	225
10 X 10	DFT1010P401	3,084.00	270
12 X 4	DFT1204P401	3,691.00	290
12 X 6	DFT1206P401	3,579.00	295
12 X 8	DFT1208P401	3,724.00	310
12 X 10	DFT1210P401	4,274.00	360
12 X 12	DFT1212P401	4,302.00	385
14 X 4	DFT1404P401	5,494.00	370
14 X 6	DFT1406P401	5,288.00	375
14 X 8	DFT1408P401	5,461.00	390
14 X 10	DFT1410P401	5,574.00	400
14 X 12	DFT1412P401	5,861.00	425
14 X 14	DFT1414P401	5,971.00	435
16 X 4	DFT1604P401	6,679.00	460
16 X 6	DFT1606P401	5,461.00	465
16 X 8	DFT1608P401	5,567.00	475
16 X 10	DFT1610P401	6,750.00	495
16 X 12	DFT1612P401	5,914.00	520
16 X 14	DFT1614P401	7,197.00	530
16 X 16	DFT1616P401	6,301.00	550
18 X 6	DFT1806P401	6,310.00	480
18 X 8	DFT1808P401	7,531.00	495
18 X 10	DFT1810P401	7,352.00	510

Size (in.)	Item No.	List Price (\$)	Wt. (lb.)
18X12	DFT1812P401	6,851.00	535
18X14	DFT1814P401	8,638.00	630
18X16	DFT1816P401	8,991.00	650
18X18	DFT1818P401	8,189.00	785
20X 6	DFT2006P401	9,224.00	610
20X 8	DFT2008P401	9,348.00	620
20X10	DFT2010P401	9,539.00	635
20X12	DFT2012P401	9,857.00	660
20X14	DFT2014P401	9,919.00	665
20X16	DFT2016P401	11,751.00	810
20X18	DFT2018P401	11,876.00	820
20X20	DFT2020P401	10,296.00	855
24X 4	DFT2404P401	POA	
24X 6	DFT2406P401	10,725.00	845
24X 8	DFT2408P401	12,682.00	860
24X10	DFT2410P401	12,933.00	880
24X12	DFT2412P401	11,139.00	890
24X14	DFT2414P401	13,102.00	900
24X16	DFT2416P401	11,371.00	915
24X18	DFT2418P401	17,233.00	1220
24X20	DFT2420P401	17,678.00	1510
24X24	DFT2424P401	15,756.00	1330
30X 6	DFT3006P401	21,971.00	1450
30X 8	DFT3008P401	22,037.00	
30X10	DFT3010P401	22,445.00	
30X12	DFT3012P401	22,445.00	1490
30X14	DFT3014P401	22,445.00	1490
30X16	DFT3016P401	22,646.00	1505
30X18	DFT3018P401	24,099.00	1515
30X20	DFT3020P401	23,117.00	1540
30X24	DFT3024P401	29,688.00	2025
30X30	DFT3030P401	26,357.00	2150
36X10	DFT3610P401	31,901.00	3082
36X12	DFT3612P401	32,104.00	2170
36X14	DFT3614P401	32,171.00	2175
36X16	DFT3616P401	32,307.00	2185
36X18	DFT3618P401	32,377.00	2190
36X20	DFT3620P401	32,645.00	2210
36X24	DFT3624P401	33,257.00	2255

Contd.....

FLANGE TEES

Contd.....

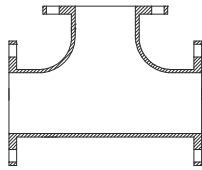

FLANGE TEES - BULL HEAD

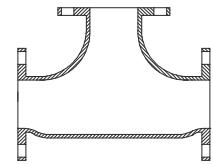

Size (in.)	Item No.	List Price (\$)	Wt. (lb.)
36X30	DFT3630P401	43,341.00	3000
36X36	DFT3636P401	37,911.00	3160
42X12	DFT4212P401	48,885.00	3165
42X14	DFT4214P401	48,961.00	3170
42X16	DFT4216P401	49,100.00	3180
42X18	DFT4218P401	49,173.00	3185
42X20	DFT4220P401	49,462.00	3205
42X24	DFT4224P401	50,040.00	3245
42X30	DFT4230P401	62,752.00	4125
42X36	DFT4236P401	80,592.00	5360
42X42	DFT4242P401	83,773.00	5580
48X12	DFT4812P401	65,952.00	4315
48X14	DFT4814P401	65,952.00	4315
48X16	DFT4816P401	66,163.00	4330
48X18	DFT4818P401	66,163.00	4330
48X20	DFT4820P401	66,453.00	4350
48X24	DFT4824P401	66,963.00	4385
48X30	DFT4830P401	67,972.00	4455
48X36	DFT4836P401	83,863.00	7035
48X42	DFT4842P401	1,07,554.00	7195
48X48	DFT4848P401	1,10,297.00	7385
54X12	DFT5412P401	POA	4435
54X14	DFT5414P401	POA	4435
54X16	DFT5416P401	POA	4450
54X18	DFT5418P401	POA	4460
54X20	DFT5420P401	POA	4480
54X24	DFT5424P401	POA	4515
54X30	DFT5430P401	POA	4615
54X36	DFT5436P401	POA	4695
54X42	DFT5442P401	POA	5740
54X48	DFT5448P401	POA	5850
54X54	DFT5454P401	POA	6025

Size (in.)	Item No.	List Price (\$)	Wt. (lb.)
4 X 4 X 6	DFTBH040406P401	POA	90
6 X 6 X 8	DFTBH060608P401	POA	140
8 X 6 X 4	DFTBH080604P401	POA	146
8 X 8 X10	DFTBH080810P401	POA	260
8 X 8 X12	DFTBH080812P401	POA	291
10X10X12	DFTBH101012P401	POA	355

FLANGE TEES - REDUCING ON THE RUN

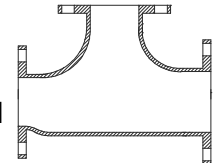

Size (in.)	Item No.	List Price (\$)	Wt. (lb.)
4 X 3 X 3	DFTROR040303P401	POA	55
6 X 4 X 4	DFTROR060404P401	POA	103
6 X 4 X 6	DFTROR060406P401	POA	108
8 X 6 X 4	DFTROR080604P401	POA	146
8 X 6 X 6	DFTROR080606P401	POA	148
8 X 6 X 8	DFTROR080608P401	POA	145
10X 6 X 6	DFTROR100606P401	POA	275
10X 6 X10	DFTROR100610P401	POA	305
10X 8 X 6	DFTROR100806P401	POA	280
10X 8 X 8	DFTROR100808P401	POA	302
10X 8 X10	DFTROR100810P401	POA	325
12X 6 X 6	DFTROR120606P401	POA	340
12X 6 X 8	DFTROR120608P401	POA	360
12X 8 X 6	DFTROR120806P401	POA	355
12X 8 X 8	DFTROR120808P401	POA	375
12X 8 X12	DFTROR120812P401	POA	420
12X10X 6	DFTROR121006P401	POA	390
12X10X 8	DFTROR121008P401	POA	400
12X10X10	DFTROR121010P401	POA	420
12X10X12	DFTROR121012P401	POA	440

FLANGE CROSS

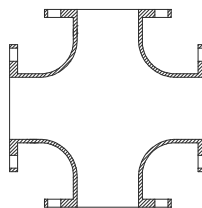

Size (in.)	Item No.	List Price (\$)	Wt. (lb.)
3 X 3	DFX0303P401	1,077.00	50
4 X 3	DFX0403P401	1,124.00	70
4 X 4	DFX0404P401	1,077.00	80
6 X 3	DFX0603P401	1,563.00	95
6 X 4	DFX0604P401	1,691.00	110
6 X 6	DFX0606P401	1,713.00	120
8 X 3	DFX0803P401	2,340.00	140
8 X 4	DFX0804P401	2,352.00	155
8 X 6	DFX0806P401	2,468.00	175
8 X 8	DFX0808P401	2,485.00	195
10X 4	DFX1004P401	3,235.00	220
10X 6	DFX1006P401	3,464.00	240
10X 8	DFX1008P401	3,746.00	265
10X10	DFX1010P401	4,481.00	330
12X 4	DFX1204P401	4,405.00	310
12X 6	DFX1206P401	4,518.00	320
12X 8	DFX1208P401	4,804.00	345
12X10	DFX1210P401	5,599.00	415
12X12	DFX1212P401	5,133.00	460
14X 6	DFX1406P401	5,574.00	400
14X 8	DFX1408P401	5,861.00	425
14X10	DFX1410P401	6,255.00	460
14X12	DFX1412P401	6,770.00	505
14X14	DFX1414P401	7,051.00	530
16X 6	DFX1606P401	6,741.00	490
16X 8	DFX1608P401	7,081.00	520
16X10	DFX1610P401	7,478.00	555
16X12	DFX1612P401	8,048.00	605
16X14	DFX1614P401	11,406.00	620
16X16	DFX1616P401	8,731.00	755
18X 6	DFX1806P401	7,291.00	505
18X 8	DFX1808P401	7,641.00	535
18X10	DFX1810P401	7,935.00	560
18X12	DFX1812P401	8,523.00	610
18X14	DFX1814P401	9,812.00	720
18X16	DFX1816P401	10,344.00	765
18X18	DFX1818P401	10,691.00	795
20X 6	DFX2006P401	9,539.00	635
20X 8	DFX2008P401	9,919.00	665

Size (in.)	Item No.	List Price (\$)	Wt. (lb.)
20X10	DFX2010P401	10,172.00	685
20X12	DFX2012P401	10,802.00	735
20X14	DFX2014P401	10,931.00	745
20X16	DFX2016P401	13,080.00	915
20X18	DFX2018P401	13,458.00	945
20X20	DFX2020P401	14,344.00	1015
24X 6	DFX2406P401	12,872.00	875
24X 8	DFX2408P401	13,128.00	895
24X10	DFX2410P401	13,568.00	930
24X12	DFX2412P401	13,947.00	960
24X14	DFX2414P401	14,138.00	975
24X16	DFX2416P401	14,580.00	1010
24X18	DFX2418P401	19,067.00	1365
24X20	DFX2420P401	19,886.00	1430
24X24	DFX2424P401	21,655.00	1570
30X10	DFX3010P401	POA	
30X12	DFX3012P401	23,460.00	1565
30X14	DFX3014P401	23,527.00	1570
30X16	DFX3016P401	23,999.00	1605
30X18	DFX3018P401	24,138.00	1515
30X20	DFX3020P401	24,881.00	1670
30X24	DFX3024P401	32,668.00	2245
30X30	DFX3030P401	36,118.00	2500
36X12	DFX3612P401	33,048.00	2240
36X14	DFX3614P401	33,048.00	2240
36X16	DFX3616P401	33,460.00	2270
36X18	DFX3618P401	33,593.00	2280
36X20	DFX3620P401	34,202.00	2325
36X24	DFX3624P401	35,284.00	2405
36X30	DFX3630P401	47,406.00	3300
36X36	DFX3636P401	51,741.00	3620
42X12	DFX4212P401	50,123.00	3240
42X14	DFX4214P401	50,123.00	3240
42X16	DFX4216P401	50,588.00	3270
42X18	DFX4218P401	49,478.00	3275
42X20	DFX4220P401	51,360.00	3320
42X24	DFX4224P401	52,521.00	4135
42X30	DFX4230P401	67,678.00	4375
42X36	DFX4236P401	88,484.00	5720

Contd.....

P401
P401
P401
P401
P401
P401

P 401

P 401

P 401

P 401

P 401

P 401

FLANGE CROSS

Contd.....

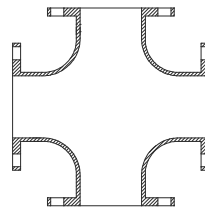

Size (in.)	Item No.	List Price (\$)	Wt. (lb.)
42X42	DFX4242P401	95,215.00	6155
48X12	DFX4812P401	67,495.00	4390
48X14	DFX4814P401	67,417.00	4385
48X16	DFX4816P401	67,880.00	4415
48X18	DFX4818P401	67,956.00	4420
48X20	DFX4820P401	68,569.00	4460
48X24	DFX4824P401	69,723.00	4535
48X30	DFX4830P401	71,798.00	5705
48X36	DFX4836P401	90,402.00	7310
48X42	DFX4842P401	1,17,307.00	7630
48X48	DFX4848P401	1,27,559.00	8005

Size (in.)	Item No.	List Price (\$)	Wt. (lb.)
54X12	DFX5412P401	POA	4575
54X14	DFX5414P401	POA	4575
54X16	DFX5416P401	POA	4605
54X18	DFX5418P401	POA	4625
54X20	DFX5420P401	POA	4665
54X24	DFX5424P401	POA	4700
54X30	DFX5430P401	POA	4800
54X36	DFX5436P401	POA	4950
54X42	DFX5442P401	POA	6210
54X48	DFX5448P401	POA	6425
54X54	DFX5454P401	POA	6780

FLANGE LATERAL WYES

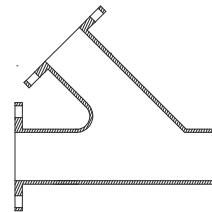

Size (in.)	Item No.	List Price (\$)	Wt. (lb.)
3 X 3	DFY0303P401	982.00	45
4 X 2	DFY0402P401	POA	
4 X 3	DFY0403P401	1,067.00	65
4 X 4	DFY0404P401	982.00	75
6 X 3	DFY0603P401	POA	
6 X 4	DFY0604P401	1,750.00	105
6 X 6	DFY0606P401	1,545.00	120
8 X 4	DFY0804P401	2,636.00	165
8 X 6	DFY0806P401	2,553.00	175
8 X 8	DFY0808P401	2,401.00	200
10X 4	DFY1004P401	3,691.00	240
10X 6	DFY1006P401	3,803.00	250
10X 8	DFY1008P401	4,088.00	335
10X10	DFY1010P401	3,642.00	335
12X 4	DFY1204P401	5,200.00	350
12X 6	DFY1206P401	5,370.00	427
12X 8	DFY1208P401	5,313.00	452

Size (in.)	Item No.	List Price (\$)	Wt. (lb.)
12X10	DFY1210P401	6,053.00	420
12X12	DFY1212P401	5,333.00	515
14X 6	DFY1406P401	6,938.00	475
14X 8	DFY1408P401	7,224.00	500
14X10	DFY1410P401	6,995.00	525
14X12	DFY1412P401	8,075.00	570
14X14	DFY1414P401	7,907.00	605
16X 6	DFY1606P401	8,218.00	620
16X 8	DFY1608P401	9,242.00	645
16X10	DFY1610P401	9,581.00	675
16X12	DFY1612P401	9,298.00	715
16X14	DFY1614P401	10,606.00	755
16X16	DFY1616P401	10,323.00	805
18X 6	DFY1806P401	POA	
18X 8	DFY1808P401	8,700.00	780
18X10	DFY1810P401	11,751.00	810
18X12	DFY1812P401	12,279.00	850

Contd.....

FLANGE LATERAL WYES

Contd.....

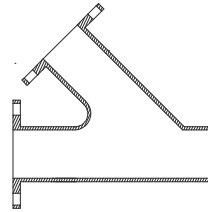

Size (in.)	Item No.	List Price (\$)	Wt. (lb.)
18X14	DFY1814P401	12,804.00	885
18X16	DFY1816P401	13,392.00	935
18X18	DFY1818P401	12,862.00	1035
20X 8	DFY2008P401	POA	740
20X10	DFY2010P401	11,689.00	1025
20X12	DFY2012P401	15,543.00	1065
20X14	DFY2014P401	16,869.00	1110
20X16	DFY2016P401	17,565.00	1155
20X18	DFY2018P401	17,617.00	1200
20X20	DFY2020P401	17,503.00	1265
24X 6	DFY2406P401	POA	
24X 8	DFY2408P401	POA	1425
24X10	DFY2410P401	POA	1460
24X12	DFY2412P401	16,979.00	1550
24X14	DFY2414P401	18,412.00	1560
24X16	DFY2416P401	25,700.00	1615
24X18	DFY2418P401	24,423.00	1680
24X20	DFY2420P401	25,084.00	1750
24X24	DFY2424P401	25,892.00	1905
30X12	DFY3012P401	43,793.00	2545
30X14	DFY3014P401	43,793.00	2590
30X16	DFY3016P401	44,332.00	2645
30X18	DFY3018P401	44,599.00	2690
30X20	DFY3020P401	45,278.00	2760
30X24	DFY3024P401	45,668.00	2915
30X30	DFY3030P401	45,941.00	3225
36X12	DFY3612P401	66,812.00	4490
36X14	DFY3614P401	66,954.00	4545
36X16	DFY3616P401	67,300.00	4000
36X18	DFY3618P401	67,390.00	4670

Size (in.)	Item No.	List Price (\$)	Wt. (lb.)
36X20	DFY3620P401	67,963.00	4750
36X24	DFY3624P401	68,666.00	4920
36X30	DFY3630P401	78,238.00	5255
36X36	DFY3636P401	80,448.00	5740
42X12	DFY4212P401	84,557.00	5725
42X14	DFY4214P401	84,688.00	5800
42X16	DFY4216P401	84,929.00	5850
42X18	DFY4218P401	85,053.00	6000
42X20	DFY4220P401	85,540.00	6680
42X24	DFY4224P401	85,578.00	6850
42X30	DFY4230P401	1,08,101.00	7185
42X36	DFY4236P401	1,13,977.00	7670
42X42	DFY4242P401	1,45,242.00	9185
48X12	DFY4812P401	1,12,157.00	7200
48X14	DFY4814P401	1,12,157.00	7276
48X16	DFY4816P401	1,12,521.00	7400
48X18	DFY4818P401	1,12,521.00	7620
48X20	DFY4820P401	1,12,995.00	7685
48X24	DFY4824P401	1,13,844.00	8695
48X30	DFY4830P401	1,15,536.00	5573
48X36	DFY4836P401	1,42,541.00	9515
48X42	DFY4842P401	1,46,043.00	11030
48X48	DFY4848P401	1,91,139.00	12115
54X24	DFY5424P401	POA	6220
54X30	DFY5430P401	POA	7478
54X36	DFY5436P401	POA	7600
54X42	DFY5442P401	POA	8930
54X48	DFY5448P401	POA	9480
54X54	DFY5454P401	POA	11780
60X30	DFY6030P401	POA	9045

P401 P401 P401 P401 P401 P401 P401

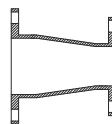
CONCENTRIC REDUCER

Size (in.)	Item No.	List Price (\$)	Wt. (lb.)
3 X 2	DFCR0302P401	POA	16
4 X 2	DFCR0402P401	POA	25
4 X 2.5	DFCR0402.5P401	POA	26
4 X 3	DFCR0403P401	568.00	30
6 X 2	DFCR0602P401	POA	35
6 X 3	DFCR0603P401	891.00	40
6 X 4	DFCR0604P401	877.00	45
6 X 5	DFCR0605P401	1,025.00	52
8 X 3	DFCR0803P401	1,215.00	60
8 X 4	DFCR0804P401	1,238.00	65
8 X 5	DFCR0805P401	1,392.00	70
8 X 6	DFCR0806P401	1,301.00	75
10X 4	DFCR1004P401	1,703.00	85
10X 6	DFCR1006P401	1,660.00	90
10X 8	DFCR1008P401	1,890.00	110
12X 4	DFCR1204P401	2,244.00	120
12X 6	DFCR1206P401	2,251.00	130
12X 8	DFCR1208P401	2,416.00	145
12X10	DFCR1210P401	2,615.00	170
14X 6	DFCR1406P401	2,793.00	155
14X 8	DFCR1408P401	3,021.00	175
14X10	DFCR1410P401	3,213.00	190
14X12	DFCR1412P401	3,083.00	248
16X 6	DFCR1606P401	3,333.00	190
16X 8	DFCR1608P401	3,134.00	210
16X10	DFCR1610P401	3,377.00	235
16X12	DFCR1612P401	3,821.00	265
16X14	DFCR1614P401	4,352.00	280
18X 8	DFCR1808P401	4,179.00	240
18X10	DFCR1810P401	4,473.00	265
18X12	DFCR1812P401	4,400.00	295
18X14	DFCR1814P401	5,000.00	310
18X16	DFCR1816P401	4,876.00	340
20X 6	DFCR2006P401	POA	

Size (in.)	Item No.	List Price (\$)	Wt. (lb.)
20X 8	DFCR2008P401	POA	
20X10	DFCR2010P401	5,429.00	310
20X12	DFCR2012P401	5,257.00	345
20X14	DFCR2014P401	6,002.00	355
20X16	DFCR2016P401	5,531.00	390
20X18	DFCR2018P401	6,698.00	410
24X 8	DFCR2408P401	POA	410
24X10	DFCR2410P401	POA	
24X12	DFCR2412P401	8,265.00	480
24X14	DFCR2414P401	8,434.00	490
24X16	DFCR2416P401	7,385.00	525
24X18	DFCR2418P401	8,764.00	550
24X20	DFCR2420P401	9,270.00	590
30X12	DFCR3012P401	POA	825
30X16	DFCR3016P401	12,827.00	770
30X18	DFCR3018P401	13,236.00	810
30X20	DFCR3020P401	14,047.00	870
30X24	DFCR3024P401	15,400.00	970
36X16	DFCR3616P401	18,539.00	1105
36X18	DFCR3618P401	POA	
36X20	DFCR3620P401	POA	1230
36X24	DFCR3624P401	20,931.00	1345
36X30	DFCR3630P401	23,779.00	1555
42X24	DFCR4224P401	29,456.00	1820
42X30	DFCR4230P401	32,924.00	2060
42X36	DFCR4236P401	37,039.00	2550
48X30	DFCR4830P401	41,536.00	2625
48X36	DFCR4836P401	46,231.00	2950
48X42	DFCR4842P401	51,576.00	3320
54X30	DFCR5430P401	POA	1625
54X36	DFCR5436P401	POA	1680
54X42	DFCR5442P401	POA	1800
54X48	DFCR5448P401	POA	1695

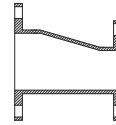
ECCENTRIC REDUCER

Size (in.)	Item No.	List Price (\$)	Wt. (lb.)
3 X 2	DFER0302P401	POA	16
4 X 2	DFER0402P401	POA	25
4 X 3	DFER0403P401	637.00	30
6 X 2	DFER0602P401	POA	35
6 X 3	DFER0603P401	891.00	40
6 X 4	DFER0604P401	957.00	45
6 X 5	DFER0605P401	1,039.00	52
8 X 3	DFER0803P401	POA	60
8 X 4	DFER0804P401	1,330.00	65
8 X 5	DFER0805P401	1,392.00	70
8 X 6	DFER0806P401	1,442.00	75
10 X 4	DFER1004P401	1,703.00	85
10 X 6	DFER1006P401	1,758.00	90
10 X 8	DFER1008P401	1,986.00	110
12 X 4	DFER1204P401	2,244.00	120
12 X 6	DFER1206P401	2,358.00	130
12 X 8	DFER1208P401	2,528.00	145
12 X 10	DFER1210P401	2,814.00	170
14 X 6	DFER1406P401	2,793.00	155
14 X 8	DFER1408P401	2,963.00	175
14 X 10	DFER1410P401	3,186.00	190
14 X 12	DFER1412P401	3,587.00	248
16 X 6	DFER1606P401	3,333.00	190
16 X 8	DFER1608P401	3,557.00	210
16 X 10	DFER1610P401	3,846.00	235
16 X 12	DFER1612P401	4,183.00	265
16 X 14	DFER1614P401	4,352.00	280
18 X 8	DFER1808P401	4,179.00	240
18 X 10	DFER1810P401	4,473.00	265
18 X 12	DFER1812P401	4,822.00	295
18 X 14	DFER1814P401	5,000.00	310
18 X 16	DFER1816P401	5,350.00	340
20 X 8	DFER2008P401	POA	
20 X 10	DFER2010P401	5,429.00	310

Size (in.)	Item No.	List Price (\$)	Wt. (lb.)
20X12	DFER2012P401	5,874.00	345
20X14	DFER2014P401	6,002.00	355
20X16	DFER2016P401	6,442.00	390
20X18	DFER2018P401	6,693.00	410
24X 8	DFER2408P401	POA	
24X10	DFER2410P401	POA	
24X12	DFER2412P401	7,880.00	480
24X14	DFER2414P401	8,005.00	490
24X16	DFER2416P401	8,448.00	525
24X18	DFER2418P401	8,764.00	550
24X20	DFER2420P401	9,270.00	590
30X10	DFER3010P401	POA	
30X14	DFER3014P401	16,169.00	825
30X16	DFER3016P401	14,928.00	770
30X18	DFER3018P401	13,302.00	810
30X20	DFER3020P401	14,047.00	870
30X24	DFER3024P401	15,400.00	970
36X14	DFER3614P401	POA	1290
36X16	DFER3616P401	POA	1105
36X18	DFER3618P401	POA	
36X20	DFER3620P401	POA	1230
36X24	DFER3624P401	20,859.00	1345
36X30	DFER3630P401	POA	1555
42X24	DFER4224P401	29,456.00	1820
42X30	DFER4230P401	32,924.00	2060
42X36	DFER4236P401	37,039.00	2550
48X24	DFER4824P401	POA	
48X30	DFER4830P401	41,536.00	2625
48X36	DFER4836P401	46,231.00	2950
48X42	DFER4842P401	51,576.00	3320
54X30	DFER5430P401	POA	1625
54X36	DFER5436P401	POA	1680
54X42	DFER5442P401	POA	1800
54X48	DFER5448P401	POA	1695

P401

P401

P401

P401

P401

P401

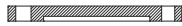
BLIND FLANGES

Size (in.)	Item No.	List Price (\$)	Wt. (lb.)
2	DBF02P401	POA	9
3	DBF03P401	391.00	9
4	DBF04P401	478.00	16
6	DBF06P401	731.00	25
8	DBF08P401	996.00	42
10	DBF10P401	1,499.00	63
12	DBF12P401	2,016.00	85
14	DBF14P401	2,838.00	120
16	DBF16P401	3,445.00	145
18	DBF18P401	4,771.00	195
20	DBF20P401	6,445.00	245
24	DBF24P401	9,588.00	370
30	DBF30P401	14,091.00	500
36	DBF36P401	27,038.00	960
42	DBF42P401	39,055.00	1300
48	DBF48P401	52,266.00	1740
54	DBF54P401	POA	2600

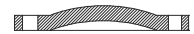
**2" TAPPED
BLIND FLANGES**

Size (in.)	Item No.	List Price (\$)	Wt. (lb.)
3	DBFT03P401	573.00	9
4	DBFT04P401	573.00	16
6	DBFT06P401	776.00	25
8	DBFT08P401	1,179.00	42
10	DBFT10P401	1,685.00	63
12	DBFT12P401	2,201.00	85
14	DBFT14P401	3,129.00	120
16	DBFT16P401	3,735.00	145
18	DBFT18P401	5,143.00	195
20	DBFT20P401	6,822.00	245
24	DBFT24P401	9,967.00	370
30	DBFT30P401	14,658.00	500
36	DBFT36P401	27,605.00	960
42	DBFT42P401	39,810.00	1300
48	DBFT48P401	53,022.00	1740
54	DBFT54P401	POA	2600

NOTES



SIP Industries

Quality Manufacturers Since 1960



PRODUCT LINE

AWWA DI Fittings & Accessories

- C153 Compact MJ Fittings and Acc. 2" - 64"
- C110 Full Body MJ Fittings 2" - 64"
- C153 Trim Tyton® Push-On Fittings 4" - 24"
- C110 Flange Fittings 2" - 64"
- MJ x MJ Adapter for Connecting MJ Bells 3" - 24"
- Stainless Steel & Blue T-Bolts
- Made in India, China & Mexico
- Bare, Cement, Zinc, FBE & Other Linings

Joint Restraint System

- EZD Joint Restraint for DI Pipe 3" - 48"
- EZDTP Joint Restraint Tandem for DI Pipe 3" - 48"
- EZDPTP Joint Restraint for Push-On Joints DI Pipe 3" - 48"
- Ductile Iron Retainer Glands 3" - 30"
- FAR / FAH Flange Adapter for DI Pipe 3" - 48"
- EZFA Restrained Flange Adapter for DI and PVC Pipe 3" - 36"
- EZPVC Joint Restraint for PVC Pipe 3" - 36"
- ULTRA Joint Restraint for PVC Pipe 4" - 12"
- EZPVCPTP Joint Restraint for Push-On Joints PVC Pipe 14" - 36"
- PTPVC Pipe to Pipe Restraint 4" - 48"
- PTPDF Pipe to MJ Fittings Restraint 4" - 48"
- PTPFC Pipe to PVC Fittings Restraint 4" - 12"
- Made in China & USA
- EZ Shield or Shop Coating

Municipal Construction Castings

- Manhole Rings and Cover
- Frames and Grates
- Valve Boxes and Service Boxes
- Water Meter Covers and Boxes
- Cleanout and Monument Boxes
- Detectable Warning Plates
- Extension Rings
- Trench Grates and Tree Grates
- Made in India & USA

Fabrication Products for DI Pipe

- High Hub Flanges Class 150 and 250. 3" - 64"
- Threaded Bell Flanges 3" - 48"
- Anchor Flanges 3" - 60"
- Filler Flanges 4" - 30"

Other Products and Services

- All Thread Rod
- Pipe Lube and Hydraulic Cement
- Socket Clamps and Lugs
- Flange Packs
- OEM Castings



SIP CORPORATE 8876 Gulf Freeway, Suite 500, Houston, TX 77017

SIP CENTRAL 2900 Patio Drive, Houston, TX 77017

SIP EAST 600 Rayloc Drive, Atlanta, GA 30336

SIP WEST 8333 Almeria Avenue, Fontana, CA 92335

Phone: 877-921-6111 or 713-923-6111 | Fax: 713-923-6114 | www.sipindustries.com | sales@sipindustries.com