



SIP Industries

Quality Manufacturers Since 1960



Compact MJ Fittings

ANSI/AWWA C153/21.53

www.sipindustries.com

Toll Free 877-921-6111



★ ★ ★
SIP INDUSTRIES
SERAMPORE
SINCE 1960

TABLE OF CONTENTS

General Terms & Conditions.....	Page : CMJ02-CMJ04
General & Technical Specifications.....	Page : CMJ05
MJ X MJ Bends.....	Page : CMJ06
MJ X PE Bends.....	Page : CMJ06
MJ X FLANGE Bends.....	Page : CMJ07
MJ X MJ Tees.....	Page : CMJ07-CMJ09
MJ X FLANGE Tees.....	Page : CMJ07-CMJ09
MJ X SWIVEL Hydrants Tees.....	Page : CMJ07-CMJ09
MJ Crocess.....	Page : CMJ07-CMJ09
MJ X MJ Tapped Tees.....	Page : CMJ09
MJ X PE Cutting in Sleeve.....	Page : CMJ09
MJ X FLANGE Adapter.....	Page : CMJ10
MJ Sleeves.....	Page : CMJ10
MJ X PE X MJ Tees.....	Page : CMJ10
MJ X MJ Tangential Tees.....	Page : CMJ10
MJ X SWIVEL Parallel Tees.....	Page : CMJ10
MJ X MJ Reducers.....	Page : CMJ11
PE X Small End MJ Reducers.....	Page : CMJ11
Large End MJ X PE Reducers.....	Page : CMJ11
PE X PE Reducers.....	Page : CMJ11
MJ X FLANGE Reducers.....	Page : CMJ11
MJ X ECCENTRIC Reducers.....	Page : CMJ11
MJ Laterals.....	Page : CMJ12
MJ Offsets.....	Page : CMJ12
SWIVEL X SOLID Hydrant Adapters.....	Page : CMJ12
SWIVEL Glands.....	Page : CMJ12
SWIVEL X SWIVEL Hydrant Adapters.....	Page : CMJ13
SWIVEL X SWIVEL Hydrant Ell.....	Page : CMJ13
Solid & Tapped CAPS & PLUGS.....	Page : CMJ13
MJ X Dual Purpose Sleeves.....	Page : CMJ14
MJ X MJ True Wyes.....	Page : CMJ14
90° Reducing Bend.....	Page : CMJ14

- **All dimensions are in inches unless noted otherwise.**
- **All weights are approximate in pounds unless noted otherwise.**

1. Acceptance. All sales by SIP Industries (Seller) are made pursuant to these Terms and Conditions. Submission of a purchase order to Seller, and/or acceptance of goods delivered by Seller, shall be deemed an acceptance of these Terms and Conditions by Purchaser. Please note that these Terms and Conditions may be modified from time to time; the applicable Terms and Conditions are those posted on SIP's website, www.sipindustries.com, at the time that a purchase order is accepted or an agreement otherwise confirmed. Purchaser's alteration or addition to these Terms and Conditions, as same may be in effect from time to time, is expressly rejected unless accepted in writing by an authorized representative of Seller.

2. Entire Agreement. These Terms and Conditions, together with Seller's price list and Purchaser's purchase order, when accepted by Seller, shall be the entire agreement between Seller and Purchaser. Neither Seller nor Purchaser is relying on any representations, warranties or agreements except as expressly provided in these Terms and Conditions and in an accepted purchase order. To the extent of any conflict between the terms of a purchase order or any other documents submitted by Purchaser, on the one hand, and these Terms and Conditions, on the other, these Terms and Conditions shall govern.

3. Prices. Prices and descriptions of goods stated in Seller's price lists are subject to change without notice. Prices are subject to tariffs, raw material surcharges, labor disputes and shipping surcharges. To submit a purchase order, SIP Industries item numbers and part codes should be included. Seller's quotations are on globally sourced products unless otherwise noted. The ordering party is responsible to specify any required origin as required for end use. Quotations, if provided by Seller, expire sixty (60) days from the date provided unless otherwise agreed in writing.

4. Terms. Invoices are due and payable thirty (30) days from date of shipment, unless otherwise written on the invoice or confirmed in writing by Seller. A five percent (5%) late fee will be charged on all past-due accounts. If it becomes necessary to retain attorneys to collect an account, the Purchaser is liable for Seller's attorney's fees and other costs of collection.

5. FOB point of shipment. All prices are FOB point of shipment, unless otherwise agreed in writing. Seller's responsibility for goods therefore ceases and title passes to the Purchaser at the point of shipment; all claims for damages or losses in transit must be directed to the carrier with copy to Seller within ten (10) days of shipment.

6. Delivery. Seller shall have the right to select the freight carrier unless otherwise agreed. Seller has the right to substitute material with same function and design to accommodate unforeseen delays, shortages or restrictions.

7. Cancellations, Changes and Returns. All cancellations, changes and returns must be accepted in writing by an authorized representative of Seller, otherwise they will not be valid and binding on Seller. Seller will not be responsible for unauthorized returned product. It will be the responsibility of purchaser at their expense to have unauthorized product returned or disposed of. Seller shall not be obligated to accept any cancellation, change or return, but if it does so the following terms shall apply: (i) goods must be returned to Seller's facility, in the same condition in which they were accepted by Purchaser; (ii) a handling charge of thirty-five percent (35%) of the purchase price will be deducted from the credit given to Purchaser; and (iii) shipping charges, if not prepaid by Purchaser, will likewise be deducted from the credit given to Purchaser.

8. Specially Manufactured Goods. Unless otherwise agreed, specially-manufactured goods, including goods designed to the Purchaser's specifications, may not be cancelled or returned once work has begun to design or manufacture the goods unless an agreement is reached and confirmed in writing by Seller, including compensation to Seller for work thus far done with respect to the goods.

9. Delays; Force Majeure. Seller shall not be liable for any expenses, loss or damage resulting from any delay in delivery of goods or other failure of Seller's performance due to fire, floods, acts of god, strikes, labor disputes, labor shortages, riots, accidents, transportation delays or other causes beyond the reasonable control of Seller.

10. Disclaimer regarding weights. All stated weights are approximate and are given for inventory and shipping purposes only.

11. Taxes. Seller's prices do not include sales, excise or other taxes. Purchaser shall pay all such taxes. If Purchaser claims a tax exemption, Purchaser shall provide Seller with the necessary tax-exemption numbers and certificates. If Purchaser aims a tax exemption, Purchaser shall provide Seller with the necessary tax-exemption numbers and certificates. If Seller accepts an exemption but is later required by the taxing authority to pay taxes, Purchaser shall reimburse to Seller the amount of such taxes.

12. Limited Warranty. For a period of one calendar year from the date of shipment, Seller warrants that goods sold and delivered by Seller to Purchaser will conform to the number and type of goods described in the accepted purchase order and that such goods will be free from defects in material and workmanship.

THIS LIMITED WARRANTY IS SELLER'S SOLE AND EXCLUSIVE WARRANTY. SELLER MAKES NO OTHER WARRANTY OF ANY KIND, EXPRESS OR IMPLIED. SELLER DOES NOT WARRANT THAT THE GOODS ARE FIT FOR ANY PARTICULAR PURPOSE. SELLER DOES NOT WARRANT THAT THE GOODS ARE MERCHANTABLE.

13. Product Disclaimers. All tooling required to manufacture products are the property of Seller even if tooling costs are incurred by Purchaser. Seller has the right to change product design, engineering, materials, tooling and processes that do not affect the intended use and application of the product. Seller will notify Purchaser if changes are substantial and may affect the application or appearance of the product. Furthermore, references to Buyer's specifications and similar requirements are only to describe the goods and do not give rise to any representation, warranty or other sales term.

Seller manufactures to industry standards and makes every effort to address applications of its products. Please see current technical advisory at Seller's web site, sipindustries.com, for up to date product support and recommendations. All product dimension, designs, technology, tooling, process, software, innovations, and drawings are considered intellectual property and are owned and confidential to Seller. Purchaser has no rights or privileges to SIP industries intellectual property including product applications without Seller's express written consent.

14. Prompt notice required for Limited Warranty claims. Buyer is responsible for promptly inspecting goods on delivery and notifying Seller, within sixty (60) days of delivery to Buyer, of any nonconformity or defect that would be discovered on a reasonable and customary inspection. Provided that such notice is given and that the warranty claim is made within one year, Seller will provide a replacement or price adjustment, in Seller's discretion, not to exceed the net sales price of the defective product. However, this warranty shall be of no force or effect absent such timely notice. Seller shall not in any event be responsible for labor, removal or installation charges incurred in connection with the replacement of defective goods.

15. Conditions to Limited Warranty. Purchaser shall notify Seller immediately upon discovery of a defect so that Seller may inspect the product in its installed condition. Seller shall not be responsible for defects or failures in goods of which it is not so notified; nor shall Seller be responsible for goods manufactured or sold by other parties or losses or impairments caused by such goods; nor shall Seller be responsible for defects or failure of goods due to improper installation, improper usage, normal or abnormal wear and tear, erosion or corrosion, improper storage, use or maintenance, vandalism, vehicular or other accidents, or storms or other forces beyond the control of the parties. Seller also shall not be responsible for goods that have been damaged by misuse, negligence or accident or that have been altered or repaired by any party other than Seller.

16. Limitation on Liability. In the event any remedy hereunder fails of its essential purpose and monetary damages may be imposed, Seller's liability, whether founded in contract or tort (including negligence), arising out of or resulting from (i) the Purchase Order and resulting contract or the performance or breach thereof, or (ii) the design, manufacture, delivery, sale, repair, replacement or use of the goods, shall not exceed the cost of the goods at issue in the claim. NOTWITHSTANDING ANYTHING CONTAINED HEREIN TO THE CONTRARY, SELLER SHALL NOT BE LIABLE TO PURCHASER OR ANY OTHER PERSON FOR CONSEQUENTIAL, INCIDENTAL, SPECIAL, EXEMPLARY, PUNITIVE OR OTHER INDIRECT DAMAGES, INCLUDING, WITHOUT LIMITATION, LOSS OF PROFITS, RECALL-RELATED EXPENSES, AND LOSS OF USE OF THE GOODS.

17. Purchaser specifications. If Seller has designed the goods using information provided by Purchaser, Seller shall not be responsible for design errors resulting from inaccurate or incomplete information supplied by Purchaser. If

Purchaser has provided specifications or a model or sample from which a good is designed and manufactured, Seller shall not be responsible for any defect, error or inadequacy provided that the good is designed or manufactured in compliance with Purchaser's specifications, model or sample.

18. Solvency and Security Interest. By submitting a Purchase Order, Buyer represents to Seller that Buyer is solvent and capable of timely fulfilling its payment and other obligations to Seller. Until the goods and any other indebtedness of Buyer have been paid in full, Buyer, its agents any successors: (i) will hold the goods subject to a security interest in favor of Seller allowing for the right or re-possession by Seller to the extent permitted by applicable law, (ii) will not alter, remove, destroy, or damage any identifying mark on the goods or their packaging, and (iii) will keep the goods separate from any other products.

19. Governing law; venue. All sales shall be governed by the law of the state of Texas. In the event that a lawsuit is filed between the parties on any claim arising out of or in connection with such sales, Seller and Purchaser agree that exclusive venue and jurisdiction shall be in the state or federal courts of Harris County, Texas.

20. Attorney's fees and costs. In the event of litigation between the parties with respect to the sale of goods, the prevailing party shall be entitled to recover its reasonable attorney's fees and costs, including expert witness fees.

3" - 64" DUCTILE IRON MECHANICAL JOINT COMPACT FITTINGS

General Specifications

- Material** : Ductile Iron per ASTM A536
- Pressure** : 350 PSI rating for 2" - 24" sizes, 250 PSI rating for 30" - 48" sizes and 150 PSI rating for 54" - 64" sizes
- Testing** : In accordance with ANSI/AWWA C153/A21.53 and UL, FM requirements
- Laying Length** : In accordance with ANSI/AWWA C153/A21.53
(fittings not listed in ANSI/AWWA have dimensions per SIP design as noted in the catalog)
- Deflection** : 2" - 4" = 8° | 6" = 7° | 8" - 12" = 5° | 14" - 16" = 3 ½° | 18" - 24" = 3° | 30" - 64" = 2°
- Flanges** : Flanged ends on fittings match ANSI/AWWA C115/A21.15 and ANSI B16.1 class 125 flanges
- Gaskets** : SBR in accordance with ANSI/AWWA C111/A21.11 (see fittings accessories catalog)
- T-Bolts / Nuts** : Low alloy steel in accordance with ANSI/AWWA C111/A21.11 (see fittings accessories catalog)
- Cement Lining** : In accordance with ANSI/AWWA C104/A21.4
- Coating** : Asphaltic seal coat inside and out in accordance with ANSI/AWWA C104/A21.4 and referenced in ANSI/AWWA C153/A21.53 and also available in Fusion-Bonded epoxy (FBE) power coated oxide red color in accordance with the ANSI/AWWA C116/A21.16
- Weight** : Are in pounds, unless noted otherwise and do not include accessories, cement lining and coating
- Dimensions** : All dimensions are in inches unless noted otherwise.
- Installations** : Per ANSI/AWWA C600 and C111 using DIP conforming to C150/C151 and PVC pipe conforming to C900
- Approvals** : 3" - 24" UL Listed | 3" - 24" FM Approved | 3" and higher UL/NSF Standards 61 | 3" and higher NSF/ANSI Standards 61 Approved for Drinking Water. Please consult SIP for detail listing and approvals.

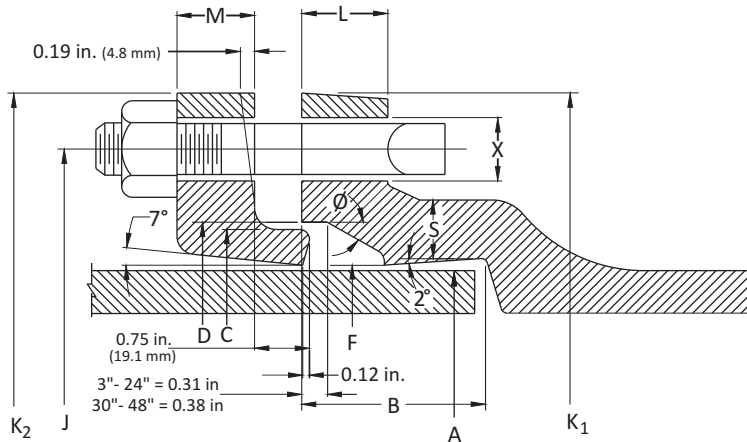

Certified to NSF/ANSI 61 & 372



ANSI/NSF 61 DRINKING WATER SYSTEM COMPONENTS

Technical Specifications

SIZE	A	B	C	D	F	J	K ₁	K ₂	M	S	L	Ø	X	BOLTS		
														NO.	SIZE	LENGTH
*2	2.50	2.50	3.39	3.50	2.61	4.75	6.19	6.25	0.62	0.36	0.58	28°	¾	2	5/8	3
3	3.96	2.50	4.84	4.94	4.06	6.19	7.62	7.69	0.62	0.39	0.58	28°	¾	4	5/8	3
4	4.80	2.50	5.92	6.02	4.90	7.50	9.06	9.12	0.75	0.39	0.60	28°	7/8	4	¾	3 ½
6	6.90	2.50	8.02	8.12	7.00	9.50	11.06	11.12	0.88	0.43	0.63	28°	7/8	6	¾	3 ½
8	9.05	2.50	10.17	10.27	9.15	11.75	13.31	13.37	1.00	0.45	0.66	28°	7/8	6	¾	3 ½
10	11.10	2.50	12.22	12.34	11.20	14.00	15.62	15.62	1.00	0.47	0.70	28°	7/8	8	¾	3 ½
12	13.20	2.50	14.32	14.44	13.30	16.25	17.88	17.88	1.00	0.49	0.73	28°	7/8	8	¾	3 ½
14	15.30	3.50	16.40	16.54	15.44	18.75	20.25	20.25	1.25	0.55	0.79	28°	7/8	10	¾	4
16	17.40	3.50	18.50	18.64	17.54	21.00	22.50	22.50	1.31	0.58	0.85	28°	7/8	12	¾	4
18	19.50	3.50	20.60	20.74	19.64	23.25	24.83	24.75	1.38	0.68	1.00	28°	7/8	12	¾	4
20	21.60	3.50	22.70	22.84	21.74	25.50	27.08	27.00	1.44	0.69	1.02	28°	7/8	14	¾	4
24	25.80	3.50	26.90	27.04	25.94	30.00	31.58	31.50	1.56	0.75	1.02	28°	7/8	16	¾	4 ½
30	32.00	4.00	33.29	33.46	32.17	36.88	39.12	39.12	2.00	0.82	1.31	20°	1 1/8	20	1	5 ½
36	38.30	4.00	39.59	39.76	38.47	43.75	46.00	46.00	2.00	1.00	1.45	20°	1 1/8	24	1	5 ½
42	44.50	4.00	45.79	45.96	44.67	50.62	53.12	53.12	2.00	1.25	1.45	20°	1 3/8	28	1 ¼	6
48	50.80	4.00	52.09	52.26	50.97	57.50	60.00	60.00	2.00	1.35	1.45	20°	1 3/8	32	1 ¼	6

NB : Fittings & Dimensions for Size 54, 60 & 64 available on request only.

All dimensions are in inches unless noted otherwise.

All weights are approximate in pounds unless noted otherwise.

* not included in AWWA C153

MJ X MJ BENDS

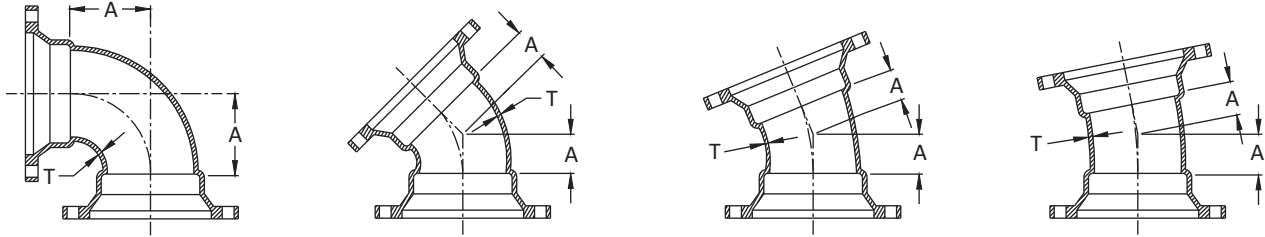

MJ X MJ		90° BENDS (¼)		45° BENDS (⅛)		22.5° BENDS (⅙)		11.25° BENDS (⅓₂)	
SIZE	T	A	WT	A	WT	A	WT	A	WT
*2	0.30	3.25	15	1.80	14	1.00	10	1.00	9
3	0.33	3.50	19	1.50	16	1.00	15	1.00	14
4	0.34	4.00	25	2.00	22	1.50	18	1.25	16
6	0.36	5.00	39	3.00	32	2.00	31	1.50	30
8	0.38	6.50	57	3.50	46	2.50	46	1.75	42
10	0.40	7.50	89	4.50	70	3.00	64	2.00	58
12	0.42	9.00	108	5.50	86	3.50	80	2.25	67
14	0.47	11.50	210	5.00	160	3.75	136	2.50	93
16	0.50	12.50	264	5.50	202	3.75	172	2.50	148
18	0.54	14.00	335	6.00	250	4.50	255	3.00	205
20	0.57	15.00	400	7.00	305	4.50	310	3.00	245
24	0.61	16.75	565	7.50	405	4.50	412	3.00	315
30	0.66	21.50	930	10.50	780	6.75	665	4.75	600
36	0.74	24.50	1450	11.50	1135	7.75	960	5.00	820
42	0.82	29.25	2205	14.00	1610	9.00	1350	6.00	1180
48	0.90	33.25	2990	15.00	2090	10.00	1760	6.50	1475

MJ X PE BENDS

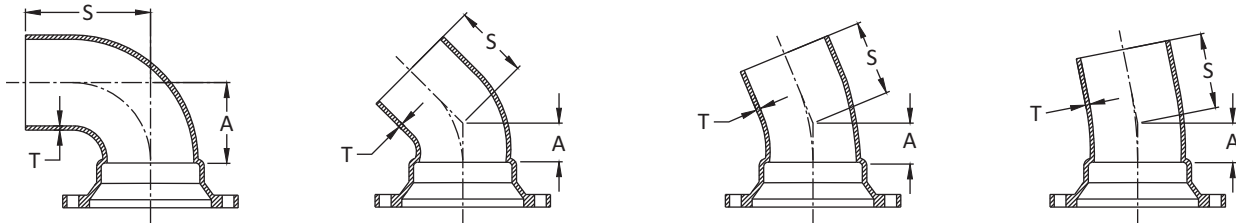

MJ X PLAIN END		90° BENDS (¼)			45° BENDS (⅛)			22.5° BENDS (⅙)			11.25° BENDS (⅓₂)		
SIZE	T	A	S	WT	A	S	WT	A	S	WT	A	S	WT
3	0.33	3.25	8.50	16	1.50	7.00	13	1.00	6.50	12	1.00	6.50	12
4	0.34	4.00	9.50	22	2.00	7.50	19	1.50	7.00	18	1.25	6.25	17
6	0.36	5.00	11.50	41	3.00	8.50	34	2.00	7.50	29	1.50	7.00	27
8	0.38	6.50	12.50	58	3.50	9.00	49	2.50	8.00	43	1.75	7.25	39
10	0.40	7.50	13.00	83	4.50	10.00	69	3.00	8.50	61	2.00	7.50	52
12	0.42	9.00	14.50	114	5.50	11.00	93	3.50	9.00	79	2.25	7.75	69
14	0.47	11.50	19.50	197	5.00	13.00	146	3.75	11.25	133	2.50	10.50	118
16	0.50	12.50	20.50	248	5.50	13.50	184	3.75	11.75	166	2.50	10.50	136
18	0.54	14.00	21.00	325	6.00	13.00	235	6.00	13.00	235	6.00	13.00	235
20	0.57	15.00	22.50	390	7.00	14.00	290	7.00	14.00	300	7.00	14.00	300
24	0.61	17.00	25.00	575	7.50	14.50	390	7.50	14.50	395	7.50	14.50	400
30	0.66	22.50	30.50	865	10.50	19.50	715	6.75	15.75	600	4.75	13.75	535
36	0.74	24.50	33.50	1355	12.00	21.00	1040	7.75	16.75	865	5.00	14.00	725
42	0.82	29.25	38.25	2055	14.00	23.00	1460	9.00	18.00	1200	6.00	15.00	1030
48	0.90	33.25	42.25	2805	15.00	24.00	1905	10.00	19.00	1575	6.50	15.50	1290

* not included in AWWA C153

All dimensions are in inches unless noted otherwise.

All weights are approximate in pounds unless noted otherwise.

MJ X FLANGE BENDS*

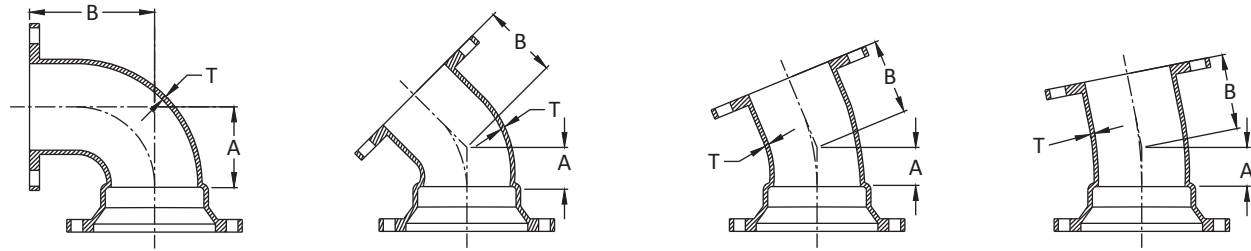

MJ X FLANGE		90° BENDS (¼)			45° BENDS (⅛)			22.5° BENDS (⅙)			11.25° BENDS (⅓₂)		
SIZE	T	A	B	WT	A	B	WT	A	B	WT	A	B	WT
3	0.33	3.50	5.50	20	1.50	3.00	17	1.00	3.00	18	1.00	3.00	16
4	0.34	4.00	6.50	26	2.00	4.00	24	1.50	4.00	27	1.25	4.00	20
6	0.36	5.00	8.00	47	3.50	5.00	39	2.00	5.00	36	1.50	5.00	30
8	0.38	6.50	9.00	68	3.50	5.50	57	2.50	5.50	53	1.75	5.50	50
10	0.40	7.50	11.00	102	4.50	6.50	83	3.00	6.50	100	2.00	6.50	75
12	0.42	9.00	12.00	134	5.50	7.50	111	3.50	7.50	145	2.25	7.50	88
14	0.47	11.50	14.00	227	5.00	7.50	208	3.75	7.50	159	2.50	7.50	145
16	0.50	12.50	15.00	306	5.50	8.00	240	3.75	8.00	218	2.50	8.00	186
18	0.54	14.00	16.50	332	6.00	8.50	252	4.50	8.50	244	3.00	8.50	229
20	0.57	15.00	18.00	440	7.00	9.50	340	4.50	9.50	319	3.00	9.50	286
24	0.61	16.75	22.00	618	7.50	11.00	441	4.50	11.00	417	3.00	11.00	395
30	0.66	21.50	25.00	1010	10.50	15.00	805	6.75	15.00	729	4.75	15.00	686
36	0.74	24.50	28.00	1456	11.50	18.00	1175	7.75	18.00	1110	5.00	18.00	1050
42	0.82	29.25	31.00	2125	14.00	21.00	1732	9.00	21.00	1587	6.00	21.00	1535
48	0.90	33.25	34.00	2950	15.00	24.00	2285	10.00	24.00	2185	6.50	24.00	2032

TEES : MJ X MJ, MJ X FLANGE, MJ X SWIVEL HYDRANT & CROSSES

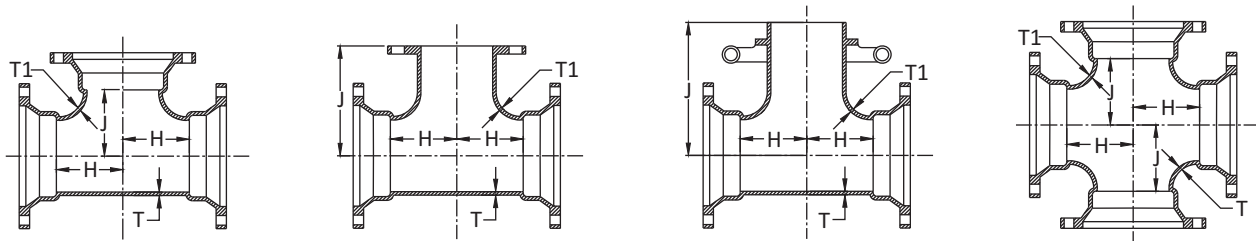

TEES & CROSSES			TEES : MJ X MJ			TEES : MJ X FE*			TEES : MJ X ST*			MJ CROSSES		
SIZE	T	T1	H	J	WT	H	J	WT	H	J	WT	H	J	WT
*2 X 2	0.30	0.30	3.25	3.25	21	---	---	---	---	---	---	---	---	---
*3 X 2	0.48	0.30	3.50	3.50	45	---	---	---	---	---	---	---	---	---
3 X 3	0.33	0.33	3.00	3.00	28	3.00	5.50	30	---	---	---	3.00	3.00	35
*4 X 2	0.34	0.30	3.00	4.00	30	---	---	---	---	---	---	---	---	---
4 X 3	0.34	0.33	3.50	4.00	30	3.50	6.50	34	---	---	---	3.50	4.00	38
4 X 4	0.34	0.34	4.00	4.00	32	4.00	6.50	40	4.00	8.50	---	4.00	4.00	40
6 X 3	0.36	0.33	3.50	5.00	42	3.50	8.00	51	---	---	---	*3.50	5.00	51
6 X 4	0.36	0.34	4.00	5.00	46	4.00	8.00	58	4.00	10.00	---	4.00	5.00	57
*6 X 4 X 6	0.36	0.36	*5.00	5.00	47	---	---	---	---	---	---	---	---	---
6 X 6	0.36	0.36	5.00	5.00	56	5.00	8.00	61	5.00	10.25	66	5.00	5.00	75
*6 X 6 X 8	0.36	0.38	*6.50	6.50	63	---	---	---	---	---	---	---	---	---
*8 X 3	0.38	0.33	*4.00	6.50	55	4.00	9.00	69	---	---	---	---	---	---
8 X 4	0.38	0.34	4.00	6.50	60	4.00	9.00	74	---	---	---	4.00	6.00	68
8 X 6	0.38	0.36	5.00	6.50	72	5.00	9.00	82	5.00	11.25	87	5.00	6.00	74
*8 X 6 X 6	0.38	0.38	*5.00	6.50	65	---	---	---	---	---	---	---	---	---
*8 X 6 X 8	0.38	0.38	*6.00	6.50	87	---	---	---	---	---	---	---	---	---
8 X 8	0.38	0.38	6.50	6.50	86	6.50	9.00	93	6.50	11.50	105	6.00	6.00	105
*10X 3	0.40	0.33	*4.00	7.50	76	---	---	---	---	---	---	3.00	7.00	111

Con't

All dimensions are in inches unless noted otherwise.

All weights are approximate in pounds unless noted otherwise.

* not included in AWWA C153

TEES : MJ X MJ, MJ X FLANGE, MJ X SWIVEL HYDRANT & CROSSES (Con't)

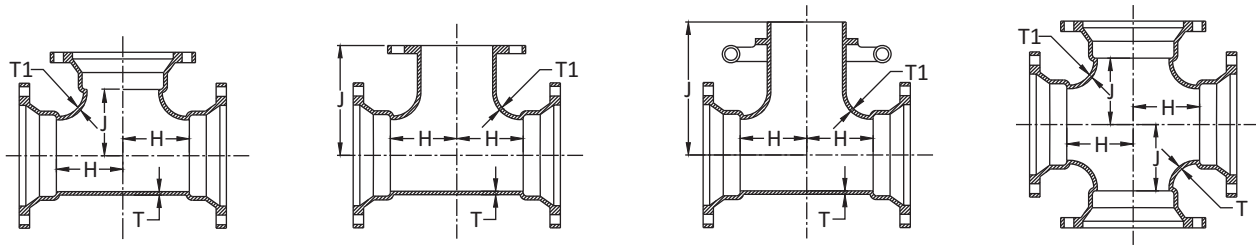

TEES & CROSSES			TEES : MJ X MJ			TEES : MJ X FE*			TEES : MJ X ST*			MJ CROSSES		
SIZE	T	T1	H	J	WT	H	J	WT	H	J	WT	H	J	WT
10X 4	0.40	0.34	4.00	7.50	78	4.00	11.00	90	---	---	---	4.00	7.00	112
10X 6	0.40	0.36	5.00	7.50	90	5.00	11.00	109	5.00	12.75	110	5.00	7.00	119
10X 8	0.40	0.38	6.50	7.50	105	6.50	11.00	116	6.50	12.75	120	6.50	7.00	124
10X10	0.40	0.40	7.50	7.50	120	7.50	11.00	132	---	---	---	7.00	7.00	145
*12X 3	0.42	0.33	*4.00	8.75	93	---	---	---	---	---	---	---	---	---
12X 4	0.42	0.34	4.00	8.75	94	4.00	12.00	118	4.00	13.50	---	4.00	8.50	119
12X 6	0.42	0.36	5.00	8.75	110	5.00	12.00	127	5.00	13.75	127	5.00	8.50	126
12X 8	0.42	0.38	6.50	8.75	125	6.50	12.00	138	6.50	13.75	130	6.00	8.50	149
12X10	0.42	0.40	7.50	8.75	140	7.50	12.00	150	---	---	---	7.50	8.50	179
12X12	0.42	0.42	8.75	8.75	160	8.75	12.00	178	8.75	13.50	---	8.50	8.50	213
14X 4	0.47	0.34	5.50	10.50	172	5.50	14.00	163	---	---	---	*5.50	10.50	164
14X 6	0.47	0.36	6.50	10.50	182	6.50	14.00	181	6.50	15.00	212	6.50	10.50	200
14X 8	0.47	0.38	7.50	10.50	206	7.50	14.00	201	7.50	15.00	220	7.50	10.50	228
14X10	0.47	0.40	8.50	10.50	228	8.50	14.00	244	---	---	---	*8.50	10.50	225
14X12	0.47	0.42	9.50	10.50	234	9.50	14.00	282	---	---	---	*9.50	10.50	247
14X14	0.47	0.47	10.50	10.50	280	10.50	14.00	298	---	---	---	10.50	10.50	299
16X 6	0.50	0.36	6.50	11.50	228	6.50	15.00	210	6.50	16.00	256	6.50	11.50	240
16X 8	0.50	0.38	7.50	11.50	248	7.50	15.00	261	7.50	16.00	300	7.50	11.50	260
16X10	0.50	0.40	8.50	11.50	264	8.50	15.00	285	---	---	---	8.50	11.50	317
16X12	0.50	0.42	9.50	11.50	280	9.50	15.00	311	---	---	---	9.50	11.50	326
16X14	0.50	0.47	10.50	11.50	316	10.50	15.00	350	---	---	---	*10.50	11.50	336
16X16	0.50	0.50	11.50	11.50	322	11.50	15.00	372	---	---	---	11.50	11.50	385
18X 6	0.54	0.36	6.50	12.50	275	6.50	15.50	324	6.50	18.00	282	*6.50	12.50	262
18X 8	0.54	0.38	7.50	12.50	295	7.50	15.50	352	7.50	17.00	271	*7.50	12.50	285
18X10	0.54	0.40	8.50	12.50	315	8.50	15.50	---	---	---	---	*8.50	12.50	311
18X12	0.54	0.42	9.50	12.50	335	9.50	15.50	360	---	---	---	9.50	12.50	348
18X14	0.54	0.47	10.50	12.50	380	10.50	16.50	---	---	---	---	*10.50	12.50	388
18X16	0.54	0.50	11.50	12.50	405	11.50	16.50	442	---	---	---	*11.50	12.50	---
18X18	0.54	0.54	12.50	12.50	435	12.50	16.50	448	---	---	---	12.50	12.50	481
20X 6	0.57	0.36	6.50	14.00	315	6.50	17.00	365	6.50	18.50	360	*6.50	14.00	325
20X 8	0.57	0.38	8.00	14.00	345	8.00	17.00	342	8.00	18.50	380	8.00	14.00	379
20X10	0.57	0.40	9.00	14.00	370	9.00	17.00	374	---	---	---	*9.00	14.00	382
20X12	0.57	0.42	10.00	14.00	395	10.00	17.00	405	---	---	---	10.00	14.00	413
20X14	0.57	0.47	11.00	14.00	440	11.00	17.00	437	---	---	---	*11.00	14.00	456
20X16	0.57	0.50	12.00	14.00	465	12.00	18.00	478	---	---	---	*12.00	14.00	632
20X18	0.57	0.54	13.00	14.00	505	13.00	18.00	510	---	---	---	*13.00	14.00	552
20X20	0.57	0.57	14.00	14.00	535	14.00	18.00	557	---	---	---	14.00	14.00	600
24X 6	0.61	0.36	7.00	16.00	415	7.00	19.00	435	7.00	19.00	461	*7.00	16.00	425
24X 8	0.61	0.38	8.00	16.00	445	8.00	19.00	426	8.00	19.00	480	8.00	16.00	481
24X10	0.61	0.40	9.00	16.00	470	9.00	19.00	466	---	---	---	*9.00	16.00	485
24X12	0.61	0.42	10.00	16.00	500	10.00	19.00	515	---	---	---	10.00	16.00	529
24X14	0.61	0.47	11.00	16.00	550	11.00	19.00	544	---	---	---	*11.00	16.00	558
24X16	0.61	0.50	12.00	16.00	580	12.00	19.00	582	---	---	---	12.00	16.00	576
24X18	0.61	0.54	13.00	16.00	625	13.00	22.00	640	---	---	---	13.00	16.00	---
24X20	0.61	0.57	14.00	16.00	660	14.00	22.00	693	---	---	---	*14.00	16.00	780
24X24	0.61	0.61	16.00	16.00	720	16.00	22.00	790	---	---	---	*17.00	17.00	885
30X6	0.66	0.36	8.00	20.00	678	8.00	23.00	805	8.00	24.50	664	8.50	20.00	670

* not included in AWWA C153

Con't

All dimensions are in inches unless noted otherwise.

All weights are approximate in pounds unless noted otherwise.

TEES : MJ X MJ, MJ X FLANGE, MJ X SWIVEL HYDRANT & CROSSES (Con't)

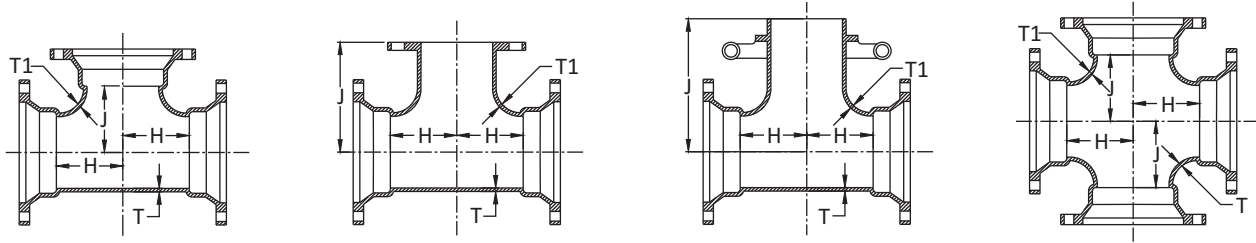

TEES & CROSSES			TEES : MJ X MJ			TEES : MJ X FE*			TEES : MJ X ST*			MJ CROSSES		
SIZE	T	T1	H	J	WT	H	J	WT	H	J	WT	H	J	WT
30X 8	0.66	0.38	8.50	20.00	739	8.50	23.00	722	---	---	---	*8.50	20.00	678
30X12	0.66	0.42	10.00	20.00	830	10.00	23.00	824	---	---	---	10.00	20.00	882
30X16	0.66	0.50	12.50	20.00	959	12.50	23.00	1028	---	---	---	*12.50	20.00	885
30X18	0.66	0.54	14.00	20.00	1039	---	---	---	---	---	---	---	---	---
30X20	0.66	0.57	15.00	20.00	995	15.00	23.00	---	---	---	---	*16.00	20.00	1012
30X24	0.66	0.61	16.00	20.00	1060	16.00	25.00	1287	---	---	---	22.00	22.00	1246
30X30	0.66	0.66	20.00	20.00	1323	20.00	25.00	1292	---	---	---	22.00	22.00	1840
36 X 6	0.74	0.36	7.00	23.50	1045	7.00	26.00	1175	7.00	27.50	901	---	---	---
36 X 8	0.74	0.38	9.00	23.50	1095	---	---	---	9.00	27.50	945	---	---	---
36X16	0.74	0.50	12.50	23.50	1385	---	---	---	---	---	---	---	---	---
36X24	0.74	0.61	16.00	23.50	1498	16.00	26.00	1949	---	---	---	16.00	23.50	1785
36X30	0.74	0.66	20.00	23.50	1555	20.00	28.00	1956	---	---	---	*26.00	26.00	---
36X36	0.74	0.74	23.50	23.50	1900	23.50	28.00	1943	---	---	---	26.00	26.00	2655
42X18	0.82	0.54	16.00	27.50	2072	---	---	---	---	---	---	---	---	---
42X24	0.82	0.61	20.00	27.50	2270	20.00	30.00	---	---	---	---	20.00	27.50	2668
42X30	0.82	0.66	22.00	29.50	2425	22.00	31.00	3163	---	---	---	22.00	29.50	2950
42X36	0.82	0.74	30.00	30.00	3000	30.00	31.00	2792	---	---	---	30.00	30.00	3607
42X42	0.82	0.82	30.00	30.00	3175	30.00	31.00	---	---	---	---	30.00	30.00	3725
48 X 6	0.90	0.36	10.00	32.00	1949	---	---	---	---	---	---	---	---	---
48X16	0.90	0.50	13.00	32.00	2657	---	---	---	---	---	---	*23.00	32.00	2623
48X24	0.90	0.61	23.00	32.00	2870	23.00	34.00	---	---	---	---	*23.00	32.00	2785
48X30	0.90	0.66	23.00	32.00	3050	23.00	34.00	2774	---	---	---	*23.00	32.00	3672
48X36	0.90	0.74	33.50	32.25	3900	33.50	34.00	3619	---	---	---	*33.50	32.25	3735
48X42	0.90	0.82	33.50	33.50	4100	33.50	34.00	3746	---	---	---	*33.50	33.50	4651
48X48	0.90	0.90	33.50	33.50	4250	33.50	34.00	3907	---	---	---	33.50	33.50	4955

TEES : MJ X MJ TAPPED (2" TAP)

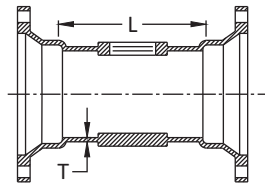

SIZE	T	L	TAP SIZE	WT
3	0.33	6.00	2	18
4	0.34	6.00	2	24
6	0.36	6.00	2	42
8	0.38	6.00	2	52
10	0.40	6.00	2	64
12	0.42	6.00	2	81
16	0.50	6.00	2	168
24	0.61	8.00	2	331

CUTTING IN SLEEVE : MJ X PE*

(WITH OVER SIZE GLAND)

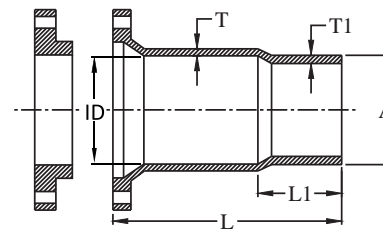

SIZE	ID	T	T1	A	L	L1	WT
4	5.10	0.36	0.34	4.80	20.00	9.00	51
6	7.20	0.38	0.36	6.90	20.00	9.00	64
8	9.40	0.40	0.38	9.05	20.00	9.00	89
10	11.50	0.42	0.40	11.10	20.00	9.00	106
12	13.60	0.47	0.42	13.20	20.00	9.00	130
16	17.94	0.54	0.50	17.40	20.00	9.00	272

All dimensions are in inches unless noted otherwise.

All weights are approximate in pounds unless noted otherwise.

* not included in AWWA C153

ADAPTER : MJ X FLANGE

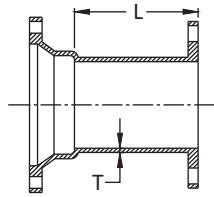

SIZE	L	T	WT
3	3.50	0.33	13
4	3.50	0.34	23
6	3.50	0.36	31
8	3.50	0.38	54
10	4.00	0.40	70
12	4.00	0.42	95
14	5.00	0.47	141
16	5.00	0.50	170
18	5.00	0.54	221
20	5.00	0.57	252
24	5.00	0.61	324
30	7.00	0.66	558
36	7.00	0.74	796
42	7.00	0.82	1190
48	7.00	0.90	1653

MJ SLEEVES

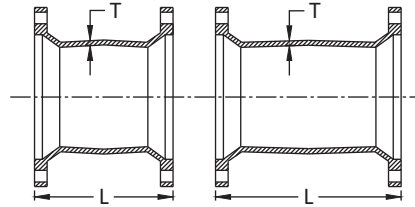

MJ SLEEVES		LONG		SHORT	
SIZE	T	L	WT	L	WT
3	0.30	12.00	13	7.50	8
3	0.33	12.00	17	7.50	12
4	0.34	12.00	20	7.50	15
6	0.36	12.00	29	7.50	23
8	0.38	12.00	45	7.50	31
10	0.40	12.00	61	7.50	45
12	0.42	12.00	76	7.50	56
14	0.47	15.00	128	9.50	94
16	0.50	15.00	159	9.50	118
18	0.54	15.00	200	9.00	145
20	0.57	15.00	236	9.00	173
24	0.61	15.00	306	9.00	226
30	0.66	24.00	634	15.00	472
36	0.74	24.00	889	15.00	673
42	0.82	24.00	1150	15.00	887
48	0.90	24.00	1435	15.00	1136

TEES : MJ X PE X MJ*

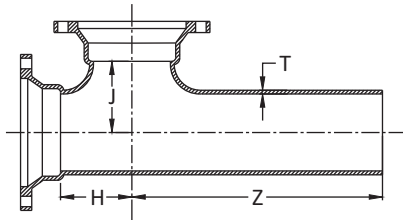

SIZE	T	H	J	Z	WT
6 X 6	0.36	5.00	5.00	12.00	59
8 X 6	0.38	5.50	6.50	11.50	72
8 X 8	0.38	6.50	6.50	12.50	80
8 X 10	0.40	7.50	7.50	13.00	125

CROSSES : MJ X FLANGE*

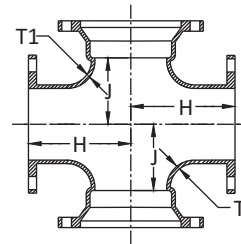

SIZE	T	T1	J	H	WT
8 X 8	0.38	0.38	9.00	6.50	133
10 X 10	0.40	0.40	11.00	7.50	190
12 X 12	0.42	0.42	12.00	8.75	260

TEES : MJ X MJ TANGENTIAL*

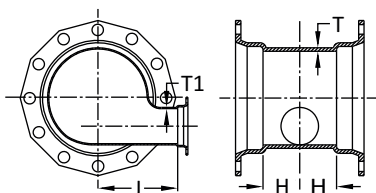

SIZE	T	T1	J	H	WT
16 X 6	0.50	0.38	11.50	6.50	226
16 X 12	0.50	0.42	11.50	9.50	304
18 X 6	0.54	0.36	12.50	6.50	287
24 X 6	0.61	0.36	16.00	7.00	458
24 X 12	0.61	0.42	16.00	10.00	542

TEES : MJ X SWIVEL PARALLEL*

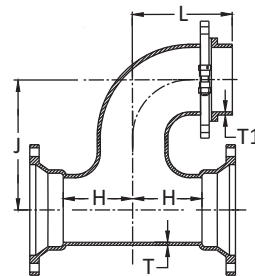

SIZE	T	T1	J	H	L	WT
6 X 6	0.36	0.36	12.50	8.00	10.00	85
8 X 6	0.38	0.36	13.50	9.00	11.00	109
10 X 6	0.40	0.36	14.00	11.00	13.00	127
12 X 6	0.42	0.36	16.00	12.00	14.00	240

* not included in AWWA C153

All dimensions are in inches unless noted otherwise.

All weights are approximate in pounds unless noted otherwise.

REDUCERS : MJ X MJ, PE X SMALL END MJ, LARGE END MJ X PE, PE X PE, MJ x FE, MJ ECENTRIC

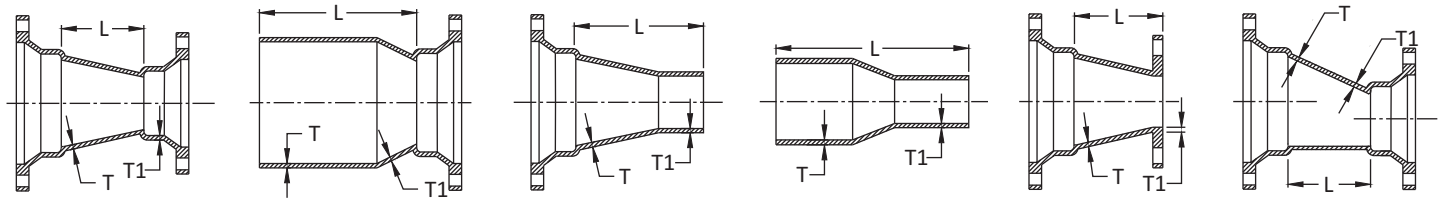

REDUCERS			MJ X MJ		PE X SEB		LEB X PE		PE X PE		MJ X FLANGE*		MJ ECCENTRIC*	
SIZE	T	T1	L	WT	L	WT	L	WT	L	WT	L	WT	L	WT
4 X 3	0.34	0.33	3.00	18	8.50	17	8.50	18	14.00	14	5.00	20	---	---
6 X 3	0.36	0.33	5.00	22	10.50	24	10.50	19	16.00	19	---	---	---	---
6 X 4	0.36	0.34	4.00	24	9.50	25	9.50	25	15.00	22	5.00	32	---	---
8 X 4	0.38	0.34	5.00	32	10.50	30	10.50	34	16.00	30	---	---	---	---
8 X 6	0.38	0.36	4.00	36	9.50	35	9.50	32	15.00	30	6.00	43	---	---
10X 4	0.40	0.34	7.00	46	12.50	43	12.50	43	18.00	46	---	---	---	---
10X 6	0.40	0.36	5.00	47	10.50	46	10.50	42	16.00	46	---	---	5.00	49
10X 8	0.40	0.38	4.00	50	9.50	42	9.50	50	15.00	47	---	---	4.00	53
12X 4	0.42	0.34	9.00	58	14.50	60	14.50	60	20.00	58	---	---	---	---
12X 6	0.42	0.36	7.00	58	12.50	58	12.50	58	18.00	57	---	---	---	---
12X 8	0.42	0.38	5.00	57	10.50	54	10.50	55	16.00	54	7.00	83	---	---
12X10	0.42	0.40	4.00	61	9.50	59	9.50	59	15.00	54	7.00	87	---	---
14X 6	0.47	0.36	9.00	100	16.90	100	14.50	104	22.30	93	---	---	---	---
14X 8	0.47	0.38	7.00	100	14.90	98	12.40	98	20.30	94	---	---	---	---
14X10	0.47	0.40	5.00	100	12.90	94	10.40	92	18.30	90	8.00	115	---	---
14X12	0.47	0.42	4.00	100	11.90	90	9.40	92	17.30	88	---	---	---	---
16X 6	0.50	0.36	11.00	124	18.90	125	16.50	136	24.30	93	---	---	---	---
16X 8	0.50	0.38	9.00	124	16.90	121	14.40	128	22.30	119	---	---	---	---
16X10	0.50	0.40	7.00	124	15.00	105	12.50	123	20.50	119	---	---	---	---
16X12	0.50	0.42	5.00	112	12.90	109	10.50	108	18.30	99	---	---	5.00	116
16X14	0.50	0.47	4.00	140	12.00	126	12.00	132	19.70	129	---	---	---	---
18X 8	0.54	0.38	13.00	190	20.00	170	19.50	195	27.40	170	16.00	193	---	---
18X10	0.54	0.40	10.00	195	18.00	165	17.40	185	25.50	160	---	---	---	---
18X12	0.54	0.42	7.00	180	15.50	150	14.00	175	19.50	150	12.00	199	---	---
18X14	0.54	0.47	6.00	190	15.00	175	15.00	190	23.00	160	---	---	---	---
18X16	0.54	0.50	5.00	195	12.50	170	12.50	190	18.00	145	---	---	---	---
20X10	0.57	0.40	14.00	220	22.00	200	19.00	210	27.50	180	---	---	---	---
20X12	0.57	0.42	12.00	205	17.50	170	16.00	205	21.50	190	---	---	---	---
20X14	0.57	0.47	10.00	200	18.00	190	17.90	205	26.00	195	---	---	---	---
20X16	0.57	0.50	7.00	200	13.50	185	13.50	200	19.00	170	---	---	8.00	237
20X18	0.57	0.54	4.00	225	12.00	200	12.00	215	20.00	190	---	---	---	---
24X12	0.61	0.42	16.00	305	21.50	275	21.00	290	22.50	240	18.00	322	---	---
24X14	0.61	0.47	14.00	306	22.00	310	21.90	315	25.00	295	---	---	---	---
24X16	0.61	0.50	12.00	320	17.50	285	17.50	285	23.00	285	---	---	12.00	325
24X18	0.61	0.54	10.00	305	18.00	300	18.00	310	21.00	290	---	---	---	---
24X20	0.61	0.57	7.00	300	13.50	270	13.50	275	20.00	249	---	---	7.00	373
30X16	0.66	0.50	30.00	633	39.00	565	39.00	623	48.00	555	---	---	---	---
30X18	0.66	0.54	28.00	658	37.00	590	37.00	635	46.00	567	---	---	28.00	807
30X20	0.60	0.57	24.00	628	33.00	560	33.00	603	42.00	535	---	---	24.00	633
30X24	0.66	0.61	10.00	478	24.50	45	24.50	526	33.50	458	---	---	10.00	578
36X16	0.74	0.50	30.00	1016	27.00	595	---	---	---	---	---	---	---	---
36X18	0.74	0.54	36.00	983	37.00	815	---	---	---	---	---	---	---	---
36X20	0.74	0.57	36.00	975	45.00	874	45.00	950	54.00	849	---	---	---	---
36X24	0.74	0.61	19.00	770	33.00	746	33.00	810	42.00	709	---	---	19.00	831
36X30	0.74	0.66	15.50	650	24.50	725	24.50	758	33.50	657	---	---	15.50	819
42X24	0.82	0.61	40.00	1356	49.00	1204	49.00	1319	58.00	1167	---	---	40.00	1783
42X30	0.82	0.66	20.00	1083	29.00	931	29.00	1015	38.00	863	---	---	20.00	1439
42X36	0.82	0.74	15.50	1114	24.50	962	24.50	1013	33.50	861	---	---	15.50	1117
48X24	0.90	0.61	40.00	1761	---	---	---	---	---	---	---	---	40.00	1809
48X30	0.90	0.66	40.00	1779	49.00	1594	49.00	1711	58.00	1526	---	---	40.00	1962
48X36	0.90	0.74	28.00	1641	37.00	1456	37.00	1540	46.00	1355	---	---	28.00	2011
48X42	0.90	0.82	15.50	1426	24.50	1241	24.50	1274	33.50	1089	---	---	15.50	1475

All dimensions are in inches unless noted otherwise.

All weights are approximate in pounds unless noted otherwise.

* not included in AWWA C153

MJ LATERALS*

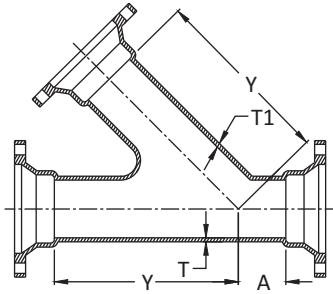

SIZE	A	Y	T	T1	WT
3 X 3	2.50	8.50	0.33	0.33	37
4 X 3	2.50	8.50	0.34	0.33	42
4 X 4	2.50	8.50	0.34	0.34	44
6 X 4	1.50	11.00	0.36	0.34	55
6 X 6	3.00	12.50	0.36	0.36	89
8 X 4	0.50	13.00	0.38	0.34	74
8 X 6	2.00	14.50	0.38	0.36	91
8 X 8	3.50	16.00	0.38	0.38	105
10 X 4	0.00	15.00	0.40	0.34	156
10 X 6	1.00	16.00	0.40	0.36	161
10 X 8	2.50	17.00	0.40	0.38	173
10 X 10	3.50	19.00	0.40	0.40	214
12 X 4	0.00	16.50	0.42	0.34	151
12 X 6	1.50	18.50	0.42	0.36	189
12 X 8	1.50	18.50	0.42	0.38	190
12 X 10	3.00	20.00	0.42	0.40	252
12 X 12	4.50	22.50	0.42	0.42	274
14 X 6	0.00	19.50	0.47	0.36	248
14 X 8	1.50	21.00	0.47	0.38	281
14 X 10	3.00	22.50	0.47	0.40	320
14 X 14	6.00	25.00	0.47	0.47	475
16 X 4	0.00	21.00	0.50	0.34	275
16 X 6	0.00	21.00	0.50	0.36	302
16 X 8	0.50	22.50	0.50	0.38	354
16 X 10	2.00	24.00	0.50	0.40	372
16 X 12	3.50	25.00	0.50	0.42	458
16 X 14	5.00	26.50	0.50	0.47	507
16 X 16	6.50	28.00	0.50	0.50	576

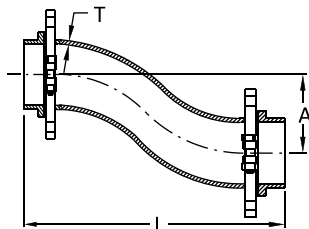
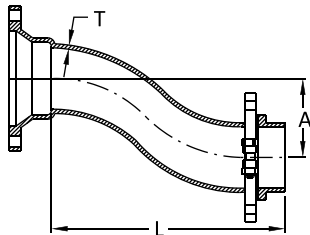

MJ OFFSETS

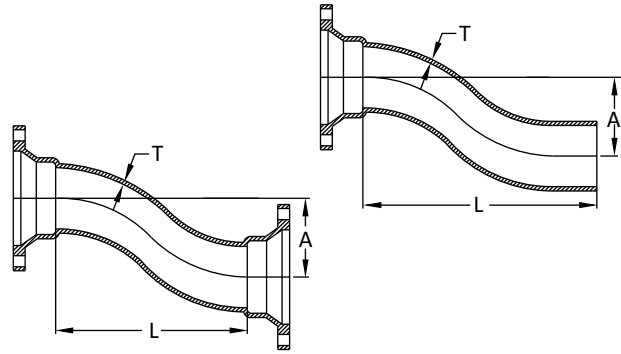

OFFSETS		MJ X MJ		MJ X PE		
SIZE	T	A	L	WT	L	WT
*3 x 6	0.33	6.00	9.00	23	---	---
*3 x 12	0.33	12.00	15.00	32	---	---
*3 x 18	0.33	18.00	21.00	42	---	---
*3 x 24	0.33	24.00	27.00	50	---	---
4 x 6	0.34	6.00	10.00	32	15.50	33
4 x 12	0.34	12.00	18.00	55	23.50	50
4 x 18	0.34	18.00	22.00	63	27.50	61
4 x 24	0.34	24.00	28.00	79	33.50	68
6 x 6	0.36	6.00	12.00	48	17.50	55
6 x 12	0.36	12.00	18.00	68	23.50	66
6 x 18	0.36	18.00	24.00	86	29.50	103
6 x 24	0.36	24.00	30.00	110	35.50	122
8 x 6	0.38	6.00	13.00	74	18.50	85
8 x 12	0.38	12.00	19.00	94	24.50	97
8 x 18	0.38	18.00	25.00	118	30.50	133
8 x 24	0.38	24.00	30.00	147	35.50	149
10 x 6	0.40	6.00	*15.00	113	20.50	127
10 x 12	0.40	12.00	21.00	144	26.50	174
10 x 18	0.40	18.00	27.00	192	32.50	202
10 x 24	0.40	24.00	33.00	244	35.50	245
12 x 6	0.42	6.00	17.00	150	22.50	132
12 x 12	0.42	12.00	23.00	192	28.50	197
12 x 18	0.42	18.00	27.00	226	32.50	273
12 x 24	0.42	24.00	35.00	272	40.50	347
*16 x 12	0.50	12.00	26.00	324	---	---
*16 x 18	0.50	18.00	36.00	406	---	---
*16 x 24	0.50	24.00	36.00	435	---	---
*20 x 12	0.57	12.00	28.00	439	---	---
*20 x 18	0.57	18.00	38.00	582	---	---

OFFSETS		MJ X SWIVEL		SWIVEL X SWIVEL		
SIZE	T	A	L	WT	L	WT
*6 x 6	0.37	6.00	15.50	48	18.00	46
*6 x 12	0.37	12.00	27.50	75	30.00	75
*6 x 24	0.37	24.00	38.50	112	41.00	107

* not included in AWWA C153

All dimensions are in inches unless noted otherwise.

All weights are approximate in pounds unless noted otherwise.

**SWIVEL X SOLID HYDRANT ADAPTER*
(WITH SWIVEL GLAND)**

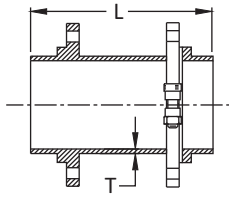

SIZE	L	T	WT
4 X	13.00	0.34	30
6 X 13	13.00	0.36	48
6 X 18	18.00	0.36	58
6 X 24	24.00	0.36	63
6 X 30	30.00	0.36	68
6 X 36	36.00	0.36	77
6 X 48	48.00	0.36	98
8 X 13	13.00	0.38	55
8 X 18	18.00	0.38	69
8 X 24	24.00	0.38	85
8 X 48	48.00	0.38	147
12X 13	13.00	0.42	118

SWIVEL GLAND*

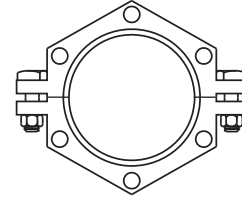

SIZE	WT
4	8
6	10
8	12
10	16
12	24

2 Nos. T-Head Bolts Required

For 4 to 8 Size - 3/4" X 3 1/2"
For 12 Size - 3/4" x 4"

**SWIVEL X SWIVEL HYDRANT ADAPTER*
WITH TWO-SWIVEL GLANDS**

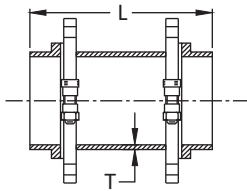

SIZE	L	T	WT
6 X 12	12.00	0.36	51
6 X 18	18.00	0.36	64
6 X 24	24.00	0.36	75

**SWIVEL X SWIVEL HYDRANT ELL*
WITH TWO-SWIVEL GLANDS**

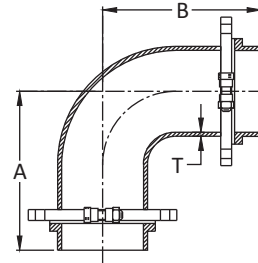

SIZE	T	A	B	WT
6	0.36	10.50	16.00	52
8	0.38	12.50	18.00	75
10	0.40	13.00	20.00	105

SOLID AND TAPPED CAPS & PLUGS

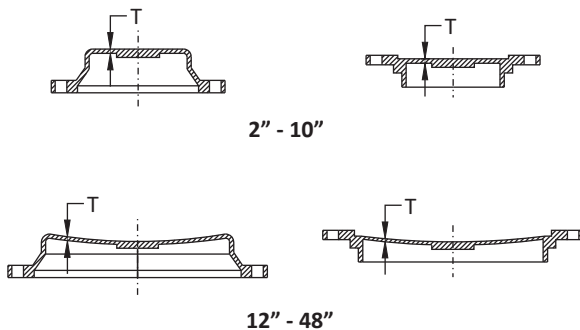

SIZE	T	MAX TAP	CAPS WT	PLUGS WT
*2	0.40	2	7	7
3	0.33	2	8	8
4	0.34	2	9	10
6	0.36	2	15	16
8	0.38	2	22	26
10	0.40	2	32	36
12	0.42	2	42	46
14	0.47	2	66	75
16	0.50	2	92	95
18	0.54	2	114	121
20	0.57	2	125	135
24	0.61	2	166	175
30	0.66	2 1/2	345	355
36	0.74	2 1/2	628	688
42	0.82	2 1/2	890	965
48	0.90	2 1/2	1110	1290

All dimensions are in inches unless noted otherwise.

All weights are approximate in pounds unless noted otherwise.

* not included in AWWA C153

MJ X DUAL PURPOSE SLEEVES*

W/OVERSIZE GLANDS

SIZE	PIPE SIZE	T	I.D.	L	WT
4	4.80 - 5.00	0.34	5.10	12.00	20
6	6.90 - 7.10	0.36	7.20	12.00	36
8	9.05 - 9.30	0.38	9.40	12.00	46
10	11.10 - 11.40	0.40	11.50	12.00	62
12	13.20 - 13.50	0.42	13.60	12.00	76
16	17.40 - 17.80	0.50	17.94	15.00	172

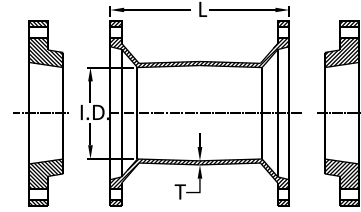

MJ X MJ TRUE WYES*

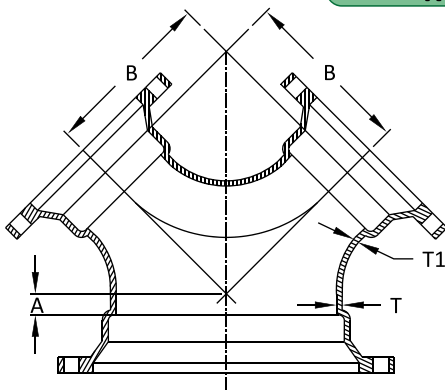

SIZE	T	T1	A	B	WT
20 X 20 X 20	0.57	0.57	7.50	15.00	550
24 X 14 X 14	0.61	0.47	9.00	11.50	395
30 X 24 X 24	0.66	0.61	8.00	17.00	815
30 X 30 X 30	0.66	0.66	10.00	21.50	1380

90° REDUCING BEND*

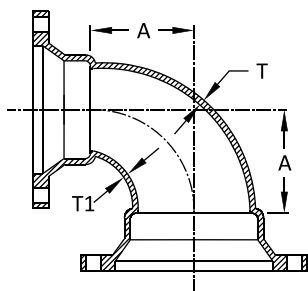

90° REDUCING BEND			MJ X MJ		PE X MJ		
SIZE	T	T1	A	WT	A	S	WT
20 X 16	0.57	0.50	15.00	348	---	---	---
48X 36	0.90	0.74	33.25	2500	33.25	42.25	2643

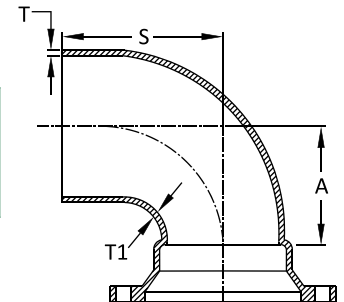

* not included in AWWA C153

All dimensions are in inches unless noted otherwise.

All weights are approximate in pounds unless noted otherwise.



SIP Industries

Quality Manufacturers Since 1960



PRODUCT LINE

AWWA DI Fittings & Accessories

- C153 Compact MJ Fittings and Acc. 2" - 64"
- C110 Full Body MJ Fittings 2" - 64"
- C153 Trim Tyton® Push-On Fittings 4" - 24"
- C110 Flange Fittings 2" - 64"
- MJ x MJ Adapter for Connecting MJ Bells 3" - 24"
- Stainless Steel & Blue T-Bolts
- Made in India, China & Mexico
- Bare, Cement, Zinc, FBE & Other Linings

Joint Restraint System

- EZD Joint Restraint for DI Pipe 3" - 48"
- EZDTP Joint Restraint Tandem for DI Pipe 3" - 48"
- EZDPTP Joint Restraint for Push-On Joints DI Pipe 3" - 48"
- Ductile Iron Retainer Glands 3" - 30"
- FAR / FAH Flange Adapter for DI Pipe 3" - 48"
- EZFA Restrained Flange Adapter for DI and PVC Pipe 3" - 36"
- EZPVC Joint Restraint for PVC Pipe 3" - 36"
- ULTRA Joint Restraint for PVC Pipe 4" - 12"
- EZPVCPTP Joint Restraint for Push-On Joints PVC Pipe 14" - 36"
- PTPVC Pipe to Pipe Restraint 4" - 48"
- PTPDF Pipe to MJ Fittings Restraint 4" - 48"
- PTPFC Pipe to PVC Fittings Restraint 4" - 12"
- Made in China & USA
- EZ Shield or Shop Coating

Municipal Construction Castings

- Manhole Rings and Cover
- Frames and Grates
- Valve Boxes and Service Boxes
- Water Meter Covers and Boxes
- Cleanout and Monument Boxes
- Detectable Warning Plates
- Extension Rings
- Trench Grates and Tree Grates
- Made in India & USA

Fabrication Products for DI Pipe

- High Hub Flanges Class 150 and 250. 3" - 64"
- Threaded Bell Flanges 3" - 48"
- Anchor Flanges 3" - 60"
- Filler Flanges 4" - 30"

Other Products and Services

- All Thread Rod
- Pipe Lube and Hydraulic Cement
- Socket Clamps and Lugs
- Flange Packs
- OEM Castings



SIP CORPORATE 8876 Gulf Freeway, Suite 500, Houston, TX 77017

SIP CENTRAL 2900 Patio Drive, Houston, TX 77017

SIP EAST 600 Rayloc Drive, Atlanta, GA 30336

SIP WEST 8333 Almeria Avenue, Fontana, CA 92335

Phone: 877-921-6111 or 713-923-6111 | Fax: 713-923-6114 | www.sipindustries.com | sales@sipindustries.com