

60+  
YEARS OF SERVICE

★★★  
**SIP INDUSTRIES**  
SERAMPORE  
SINCE 1960

# SIP Industries



Quality Manufacturers Since 1960

## Utility Pipe Fittings

# PRICE LIST

Effective : June 01, 2021

[www.sipindustries.com](http://www.sipindustries.com)

Toll Free 877-921-6111



	<b>NOTES</b>

## TABLE OF CONTENTS

GENERAL TERMS & CONDITIONS.....	Page : P002 - P004
COMPACT PUSH-ON FITTINGS ANSI/AWWA C153/A21.53.....	Page : P005 - P012
COMPACT PUSH-ON FITTINGS ZINC COATED ANSI/AWWA C153/A21.53.....	Page : P013 - P020
COMPACT PUSH-ON FITTINGS FUSION BONDED EPOXY ANSI/AWWA C153/A21.53.....	Page : P021 - P028

- All dimensions are in inches unless noted otherwise.
- All weights are approximate in pounds unless noted otherwise.
- POA = Price on availability.
- R = Available multiple size reductions.

## SIP INDUSTRIES

### GENERAL TERMS AND CONDITIONS OF SALE

**1. Acceptance.** All sales by SIP Industries (Seller) are made pursuant to these Terms and Conditions. Submission of a purchase order to Seller, and/or acceptance of goods delivered by Seller, shall be deemed an acceptance of these Terms and Conditions by Purchaser. Please note that these Terms and Conditions may be modified from time to time; the applicable Terms and Conditions are those posted on SIP's website, [www.sipindustries.com](http://www.sipindustries.com), at the time that a purchase order is accepted or an agreement otherwise confirmed. Purchaser's alteration or addition to these Terms and Conditions, as same may be in effect from time to time, is expressly rejected unless accepted in writing by an authorized representative of Seller.

**2. Entire Agreement.** These Terms and Conditions, together with Seller's price list and Purchaser's purchase order, when accepted by Seller, shall be the entire agreement between Seller and Purchaser. Neither Seller nor Purchaser is relying on any representations, warranties or agreements except as expressly provided in these Terms and Conditions and in an accepted purchase order. To the extent of any conflict between the terms of a purchase order or any other documents submitted by Purchaser, on the one hand, and these Terms and Conditions, on the other, these Terms and Conditions shall govern.

**3. Prices.** Prices and descriptions of goods stated in Seller's price lists are subject to change without notice. Prices are subject to tariffs, raw material surcharges, labor disputes and shipping surcharges. To submit a purchase order, SIP Industries item numbers and part codes should be included. Seller's quotations are on globally sourced products unless otherwise noted. The ordering party is responsible to specify any required origin as required for end use. Quotations, if provided by Seller, expire sixty (60) days from the date provided unless otherwise agreed in writing.

**4. Terms.** Invoices are due and payable thirty (30) days from date of shipment, unless otherwise written on the invoice or confirmed in writing by Seller. A five percent (5%) late fee will be charged on all past-due accounts. If it becomes necessary to retain attorneys to collect an account, the Purchaser is liable for Seller's attorney's fees and other costs of collection.

**5. FOB point of shipment.** All prices are FOB point of shipment, unless otherwise agreed in writing. Seller's responsibility for goods therefore ceases and title passes to the Purchaser at the point of shipment; all claims for damages or losses in transit must be directed to the carrier with copy to Seller within ten (10) days of shipment.

**6. Delivery.** Seller shall have the right to select the freight carrier unless otherwise agreed. Seller has the right to substitute material with same function and design to accommodate unforeseen delays, shortages or restrictions.

**7. Cancellations, Changes and Returns.** All cancellations, changes and returns must be accepted in writing by an authorized representative of Seller, otherwise they will not be valid and binding on Seller. Seller will not be responsible for unauthorized returned product. It will be the responsibility of purchaser at their expense to have unauthorized product returned or disposed of. Seller shall not be obligated to accept any cancellation, change or return, but if it does so the following terms shall apply: (i) goods must be returned to Seller's facility, in the same condition in which they were accepted by Purchaser; (ii) a handling charge of thirty-five percent (35%) of the purchase price will be deducted from the credit given to Purchaser; and (iii) shipping charges, if not prepaid by Purchaser, will likewise be deducted from the credit given to Purchaser.

**8. Specially Manufactured Goods.** Unless otherwise agreed, specially-manufactured goods, including goods designed to the Purchaser's specifications, may not be cancelled or returned once work has begun to design or manufacture the goods unless an agreement is reached and confirmed in writing by Seller, including compensation to Seller for work thus far done with respect to the goods.

**9. Delays; Force Majeure.** Seller shall not be liable for any expenses, loss or damage resulting from any delay in delivery of goods or other failure of Seller's performance due to fire, floods, acts of god, strikes, labor disputes, labor shortages, riots, accidents, transportation delays or other causes beyond the reasonable control of Seller.

**10. Disclaimer regarding weights.** All stated weights are approximate and are given for inventory and shipping purposes only.

**11. Taxes.** Seller's prices do not include sales, excise or other taxes. Purchaser shall pay all such taxes. If Purchaser claims a tax exemption, Purchaser shall provide Seller with the necessary tax-exemption numbers and certificates. If Purchaser aims a tax exemption, Purchaser shall provide Seller with the necessary tax-exemption numbers and certificates. If Seller accepts an exemption but is later required by the taxing authority to pay taxes, Purchaser shall reimburse to Seller the amount of such taxes.

**12. Limited Warranty.** For a period of one calendar year from the date of shipment, Seller warrants that goods sold and delivered by Seller to Purchaser will conform to the number and type of goods described in the accepted purchase order and that such goods will be free from defects in material and workmanship.

THIS LIMITED WARRANTY IS SELLER'S SOLE AND EXCLUSIVE WARRANTY. SELLER MAKES NO OTHER WARRANTY OF ANY KIND, EXPRESS OR IMPLIED. SELLER DOES NOT WARRANT THAT THE GOODS ARE FIT FOR ANY PARTICULAR PURPOSE. SELLER DOES NOT WARRANT THAT THE GOODS ARE MERCHANTABILITY.

**13. Product Disclaimers.** All tooling required to manufacture products are the property of Seller even if tooling costs are incurred by Purchaser. Seller has the right to change product design, engineering, materials, tooling and processes that do not affect the intended use and application of the product. Seller will notify Purchaser if changes are substantial and may affect the application or appearance of the product. Furthermore, references to Buyer's specifications and similar requirements are only to describe the goods and do not give rise to any representation, warranty or other sales term.

Seller manufactures to industry standards and makes every effort to address applications of its products. Please see current technical advisory at Seller's web site, sipindustries.com, for up to date product support and recommendations. All product dimension, designs, technology, tooling, process, software, innovations, and drawings are considered intellectual property and are owned and confidential to Seller. Purchaser has no rights or privileges to SIP industries intellectual property including product applications without Seller's express written consent.

**14. Prompt notice required for Limited Warranty claims.** Buyer is responsible for promptly inspecting goods on delivery and notifying Seller, within sixty (60) days of delivery to Buyer, of any nonconformity or defect that would be discovered on a reasonable and customary inspection. Provided that such notice is given and that the warranty claim is made within one year, Seller will provide a replacement or price adjustment, in Seller's discretion, not to exceed the net sales price of the defective product. However, this warranty shall be of no force or effect absent such timely notice. Seller shall not in any event be responsible for labor, removal or installation charges incurred in connection with the replacement of defective goods.

**15. Conditions to Limited Warranty.** Purchaser shall notify Seller immediately upon discovery of a defect so that Seller may inspect the product in its installed condition. Seller shall not be responsible for defects or failures in goods of which it is not so notified; nor shall Seller be responsible for goods manufactured or sold by other parties or losses or impairments caused by such goods; nor shall Seller be responsible for defects or failure of goods due to improper installation, improper usage, normal or abnormal wear and tear, erosion or corrosion, improper storage, use or maintenance, vandalism, vehicular or other accidents, or storms or other forces beyond the control of the parties. Seller also shall not be responsible for goods that have been damaged by misuse, negligence or accident or that have been altered or repaired by any party other than Seller.

**16. Limitation on Liability.** In the event any remedy hereunder fails of its essential purpose and monetary damages may be imposed, Seller's liability, whether founded in contract or tort (including negligence), arising out of or resulting from (i) the Purchase Order and resulting contract or the performance or breach thereof, or (ii) the design, manufacture, delivery, sale, repair, replacement or use of the goods, shall not exceed the cost of the goods at issue in the claim. NOTWITHSTANDING ANYTHING CONTAINED HEREIN TO THE CONTRARY, SELLER SHALL NOT BE LIABLE TO PURCHASER OR ANY OTHER PERSON FOR CONSEQUENTIAL, INCIDENTAL, SPECIAL, EXEMPLARY, PUNITIVE OR OTHER INDIRECT DAMAGES, INCLUDING, WITHOUT LIMITATION, LOSS OF PROFITS, RECALL-RELATED EXPENSES, AND LOSS OF USE OF THE GOODS.

**17. Purchaser specifications.** If Seller has designed the goods using information provided by Purchaser, Seller shall not be responsible for design errors resulting from inaccurate or incomplete information supplied by Purchaser. If

Purchaser has provided specifications or a model or sample from which a good is designed and manufactured, Seller shall not be responsible for any defect, error or inadequacy provided that the good is designed or manufactured in compliance with Purchaser's specifications, model or sample.

**18. Solvency and Security Interest.** By submitting a Purchase Order, Buyer represents to Seller that Buyer is solvent and capable of timely fulfilling its payment and other obligations to Seller. Until the goods and any other indebtedness of Buyer have been paid in full, Buyer, its agents any successors: (i) will hold the goods subject to a security interest in favor of Seller allowing for the right or re-possession by Seller to the extent permitted by applicable law, (ii) will not alter, remove, destroy, or damage any identifying mark on the goods or their packaging, and (iii) will keep the goods separate from any other products.

**19. Governing law; venue.** All sales shall be governed by the law of the state of Texas. In the event that a lawsuit is filed between the parties on any claim arising out of or in connection with such sales, Seller and Purchaser agree that exclusive venue and jurisdiction shall be in the state or federal courts of Harris County, Texas.

**20. Attorney's fees and costs.** In the event of litigation between the parties with respect to the sale of goods, the prevailing party shall be entitled to recover its reasonable attorney's fees and costs, including expert witness fees.

# Utility Pipe Fittings & Accessories

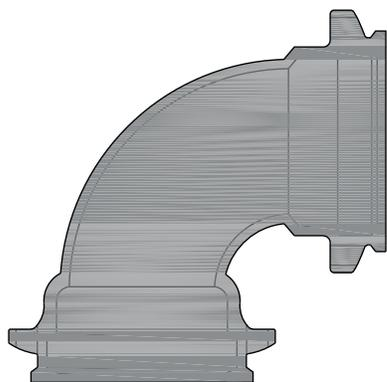

ANSI/AWWA C153/A21.53  
**COMPACT PUSH-ON FITTINGS**

**PRICE LIST**  
**Effective June 01, 2021**



**BENDS : PO X PO  
90° (1/4)**

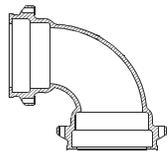

Size (in.)	Item No.	Crt. Qty.	List Price (\$)	Wt. (lb.)
4	CDPOB9004	60	226.00	28
6	CDPOB9006	32	361.00	44
8	CDPOB9008	18	534.00	71
10	CDPOB9010	12	718.00	100
12	CDPOB9012	6	1,195.00	140
14	CDPOB9014	0	1,725.00	254
16	CDPOB9016	4	3,068.00	280
18	CDPOB9018	0	4,264.00	482
20	CDPOB9020	0	4,773.00	640
24	CDPOB9024	2	5,957.00	710

**BENDS : PO X PO  
45° (1/8)**

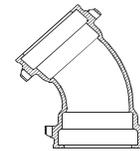

Size (in.)	Item No.	Crt. Qty.	List Price (\$)	Wt. (lb.)
4	CDPOB4504	75	207.00	23
6	CDPOB4506	36	306.00	38
8	CDPOB4508	27	447.00	54
10	CDPOB4510	18	684.00	84
12	CDPOB4512	8	911.00	110
14	CDPOB4514		1,371.00	150
16	CDPOB4516	4	2,128.00	210
18	CDPOB4518		2,441.00	309
20	CDPOB4520		3,508.00	397
24	CDPOB4524		4,351.00	455

**BENDS : PO X PO  
22½° (1/16)**

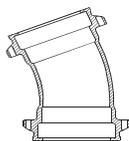

Size (in.)	Item No.	Crt. Qty.	List Price (\$)	Wt. (lb.)
4	CDPOB2204	75	197.00	22
6	CDPOB2206	48	274.00	34
8	CDPOB2208	27	367.00	55
10	CDPOB2210	18	580.00	70
12	CDPOB2212	8	763.00	90
14	CDPOB2214		1,371.00	162
16	CDPOB2216	4	2,007.00	220
18	CDPOB2218		2,709.00	209
20	CDPOB2220		3,663.00	414
24	CDPOB2224		4,948.00	455

**BENDS : PO X PO  
11¼° (1/32)**

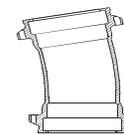

Size (in.)	Item No.	Crt. Qty.	List Price (\$)	Wt. (lb.)
4	CDPOB1104	75	199.00	21
6	CDPOB1106	48	274.00	32
8	CDPOB1108	25	377.00	52
10	CDPOB1110	18	563.00	70
12	CDPOB1112	8	752.00	95
14	CDPOB1114		1,371.00	113
16	CDPOB1116	4	2,080.00	170
18	CDPOB1118		2,716.00	209
20	CDPOB1120		3,337.00	265
24	CDPOB1124	2	7,265.00	315

**BENDS : PO X PE  
90° (1/4)**

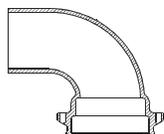

Size (in.)	Item No.	Crt. Qty.	List Price (\$)	Wt. (lb.)
4	CDPOPB9004	60	432.00	24
6	CDPOPB9006	32	409.00	48
8	CDPOPB9008		POA	

**BENDS : PO X PE  
45° (1/8)**

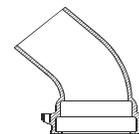

Size (in.)	Item No.	Crt. Qty.	List Price (\$)	Wt. (lb.)
4	CDPOPB4504	75	151.00	21
6	CDPOPB4506	36	329.00	38
8	CDPOPB4508	27	517.00	60

**BENDS : PO X PE**  
**22½° (1/16)**

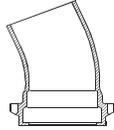

Size (in.)	Item No.	Crt. Qty.	List Price (\$)	Wt. (lb.)
4	CDPOPB2204		POA	
6	CDPOPB2206	48	306.00	35
8	CDPOPB2208	27	492.00	57

**BENDS : PO X PE**  
**11¼° (1/32)**

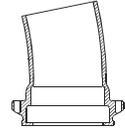

Size (in.)	Item No.	Crt. Qty.	List Price (\$)	Wt. (lb.)
4	CDPOPB1104		POA	
6	CDPOPB1106	48	312.00	35
8	CDPOPB1108	27	475.00	55

**BENDS : PO X FE**  
**90° (1/4)**

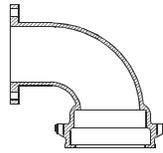

Size (in.)	Item No.	Crt. Qty.	List Price (\$)	Wt. (lb.)
4	CDPOFB9004	24	200.00	32
6	CDPOFB9006	36	499.00	49
8	CDPOFB9008	18	561.00	74
10	CDPOFB9010	16	956.00	130
12	CDPOFB9012	16	1,445.00	158
14	CDPOFB9014	0	1,366.00	231
16	CDPOFB9016	4	1,997.00	233

**BENDS : PO X FE**  
**45° (1/8)**

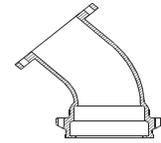

Size (in.)	Item No.	Crt. Qty.	List Price (\$)	Wt. (lb.)
4	CDPOFB4504	0	185.00	21
6	CDPOFB4506	36	392.00	42
8	CDPOFB4508	18	598.00	60
10	CDPOFB4510	0	801.00	93
12	CDPOFB4512	0	1,121.00	122
14	CDPOFB4514	0	1,392.00	162
16	CDPOFB4516	0	2,358.00	275

**BENDS : PO X FE**  
**22½° (1/16)**

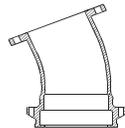

Size (in.)	Item No.	Crt. Qty.	List Price (\$)	Wt. (lb.)
4	CDPOFB2204	48	224.00	25
6	CDPOFB2206	36	294.00	44
8	CDPOFB2208	24	501.00	64
10	CDPOFB2210	12	684.00	90
12	CDPOFB2212	8	1,111.00	112
14	CDPOFB2214		1,392.00	174
16	CDPOFB2216		2,358.00	228

**BENDS : PO X FE**  
**11¼° (1/32)**

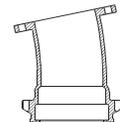

Size (in.)	Item No.	Crt. Qty.	List Price (\$)	Wt. (lb.)
4	CDPOFB1104	48	210.00	24
6	CDPOFB1106	36	294.00	30
8	CDPOFB1108	27	489.00	60
10	CDPOFB1110	12	643.00	80
12	CDPOFB1112	8	959.00	96
14	CDPOFB1114		1,461.00	170
16	CDPOFB1116		1,955.00	230

**TEES : PO X PO**

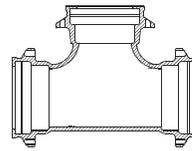

Size (in.)	Item No.	Crt. Qty.	List Price (\$)	Wt. (lb.)
4 X 4	CDPOT0404	48	325.00	46
6 X 4	CDPOT0604	24	414.00	58
6 X 6	CDPOT0606	24	436.00	66
8 X 4	CDPOT0804	16	550.00	93
8 X 6	CDPOT0806	18	615.00	103
8 X 8	CDPOT0808	18	719.00	109
10 X 4	CDPOT1004	18	852.00	95
10 X 6	CDPOT1006	12	919.00	129
10 X 8	CDPOT1008	8	1,093.00	141
10 X 10	CDPOT1010	8	1,355.00	145
12 X 4	CDPOT1204	12	1,062.00	115
12 X 6	CDPOT1206	8	960.00	164
12 X 8	CDPOT1208	8	1,203.00	166
12 X 10	CDPOT1210	4	1,372.00	175
12 X 12	CDPOT1212	4	1,336.00	193
14 X 6	CDPOT1406		1,349.00	176
14 X 10	CDPOT1410		2,975.00	195
14 X 12	CDPOT1412		3,015.00	196
14 X 14	CDPOT1414		2,902.00	209
16 X 6	CDPOT1606	2	2,508.00	231
16 X 8	CDPOT1608	4	2,727.00	265
16 X 10	CDPOT1610		2,837.00	232
16 X 12	CDPOT1612	4	3,227.00	300
16 X 14	CDPOT1614		4,331.00	349
16 X 16	CDPOT1616	4	3,854.00	261
18 X 6	CDPOT1806		3,080.00	348
18 X 8	CDPOT1808		2,875.00	325
18 X 10	CDPOT1810		3,044.00	344
18 X 12	CDPOT1812		POA	344
18 X 14	CDPOT1814		3,026.00	342
18 X 16	CDPOT1816		3,201.00	362
18 X 18	CDPOT1818		POA	377
20 X 6	CDPOT2006		3,139.00	355
20 X 10	CDPOT2010		3,264.00	369
20 X 12	CDPOT2012		POA	425
20 X 14	CDPOT2014		4,281.00	484
20 X 16	CDPOT2016		5,392.00	510
20 X 18	CDPOT2018		4,764.00	539
20 X 20	CDPOT2020		POA	564

Size (in.)	Item No.	Crt. Qty.	List Price (\$)	Wt. (lb.)
24 X 6	CDPOT2406		4,119.00	450
24 X 8	CDPOT2408		POA	492
24 X 10	CDPOT2410		4,227.00	478
24 X 12	CDPOT2412		5,861.00	541
24 X 14	CDPOT2414		4,790.00	542
24 X 16	CDPOT2416		5,004.00	566
24 X 18	CDPOT2418	2	5,243.00	593
24 X 20	CDPOT2420		5,551.00	628
24 X 24	CDPOT2424		7,813.00	884

**TEES : PO X FE**

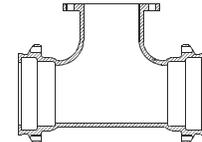

Size (in.)	Item No.	Crt. Qty.	List Price (\$)	Wt. (lb.)
4 X 4	CDPOFT0404	24	352.00	42
6 X 4	CDPOFT0604	24	451.00	59
6 X 6	CDPOFT0606	24	472.00	67
8 X 4	CDPOFT0804	18	607.00	79
8 X 6	CDPOFT0806	18	614.00	85
8 X 8	CDPOFT0808	18	751.00	105
10 X 4	CDPOFT1004	18	816.00	97
10 X 6	CDPOFT1006	8	1,050.00	102
10 X 8	CDPOFT1008	8	1,164.00	128
10 X 10	CDPOFT1010	8	1,187.00	165
12 X 4	CDPOFT1204	12	1,050.00	125
12 X 6	CDPOFT1206	8	1,042.00	135
12 X 8	CDPOFT1208	8	1,240.00	155
12 X 10	CDPOFT1210	4	1,307.00	142
12 X 12	CDPOFT1212	4	1,767.00	210
14 X 6	CDPOFT1406		2,122.00	212
14 X 8	CDPOFT1408		3,206.00	265
14 X 10	CDPOFT1410		2,874.00	246
14 X 12	CDPOFT1412		3,424.00	296
14 X 14	CDPOFT1414		3,699.00	321
16 X 6	CDPOFT1606	8	2,274.00	236
16 X 8	CDPOFT1608	8	2,816.00	269
16 X 10	CDPOFT1610		2,828.00	330

Contd.....

**TEES : PO X FE**  
Contd.....

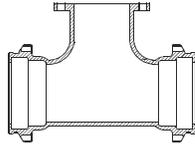

Size (in.)	Item No.	Crt. Qty.	List Price (\$)	Wt. (lb.)
16 X 12	CDPOFT1612	4	2,750.00	348
16 X 14	CDPOFT1614		3,925.00	342
16 X 16	CDPOFT1616	4	4,071.00	355
18 X 6	CDPOFT1806		2,662.00	301
18 X 8	CDPOFT1808		2,822.00	319
18 X 10	CDPOFT1810		2,981.00	337
18 X 14	CDPOFT1814		3,474.00	393
18 X 16	CDPOFT1816		3,715.00	420
20 X 6	CDPOFT2006		3,015.00	341
20 X 10	CDPOFT2010		3,902.00	420
20 X 14	CDPOFT2014		4,403.00	474
20 X 16	CDPOFT2016		4,625.00	498
20 X 18	CDPOFT2018		7,377.00	528
24 X 6	CDPOFT2406		4,751.00	512
24 X 8	CDPOFT2408		6,202.00	594
24 X 10	CDPOFT2410		4,346.00	468
24 X 12	CDPOFT2412		4,670.00	503
24 X 14	CDPOFT2414		4,927.00	531
24 X 16	CDPOFT2416		5,153.00	555

**HYDRANT TEES : PO X SWIVEL**

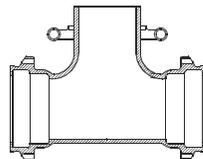

Size (in.)	Item No.	Crt. Qty.	List Price (\$)	Wt. (lb.)
6 X 6	CDPOHT0606	24	501.00	70
8 X 6	CDPOHT0806	24	858.00	90
8 X 8	CDPOHT0808		945.00	110
10X 6	CDPOHT1006		1,117.00	100
10X 8	CDPOHT1008		1,339.00	156
12X 6	CDPOHT1206	16	1,350.00	138
12X 8	CDPOHT1208		1,356.00	158
14X 6	CDPOHT1406		1,734.00	202
16X 6	CDPOHT1606	2	1,965.00	230
16X 8	CDPOHT1608		2,502.00	292
18X 6	CDPOHT1806		3,080.00	348
18X 8	CDPOHT1808		2,865.00	324
20X 6	CDPOHT2006		3,536.00	400
24X 6	CDPOHT2406		4,640.00	525

**PO CROSSES**

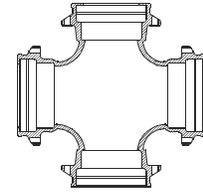

Size (in.)	Item No.	Crt. Qty.	List Price (\$)	Wt. (lb.)
4 X 4	CDPOX0404		521.00	56
6 X 4	CDPOX0604		614.00	69
6 X 6	CDPOX0606	12	568.00	83
8 X 4	CDPOX0804		1,083.00	117
8 X 6	CDPOX0806	12	843.00	115
8 X 8	CDPOX0808	12	953.00	128
10 X 4	CDPOX1004		1,062.00	116
10 X 6	CDPOX1006		1,601.00	
10 X 8	CDPOX1008		1,953.00	159
10 X 10	CDPOX1010		1,571.00	165
12 X 8	CDPOX1208	8	1,349.00	197
12 X 10	CDPOX1210		1,784.00	195
12 X 12	CDPOX1212		1,821.00	241
14 X 6	CDPOX1406		1,624.00	189
14 X 8	CDPOX1408		1,750.00	204
14 X 10	CDPOX1410		1,903.00	222
14 X 12	CDPOX 1412		2,050.00	239
14 X 14	CDPOX1414		2,314.00	270
16 X 6	CDPOX1606		2,007.00	234
16 X 8	CDPOX1608		2,767.00	323
16 X 10	CDPOX1610		POA	268
16 X 12	CDPOX1612		2,351.00	274
16 X 14	CDPOX 1614		POA	322
16 X 16	CDPOX1616		2,715.00	317
24 X 24	CDPOX2424		POA	1178

**TEES : PO X PE**

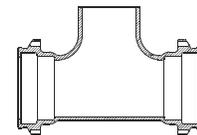

Size (in.)	Item No.	Crt. Qty.	List Price (\$)	Wt. (lb.)
6 X 6	CDPOPET0606	24	652.00	60
8 X 6	CDPOPET0806	18	992.00	75
12X 6	CDPOPET1206	8	1475.00	132

**TEES : PO TAPPED 2"**

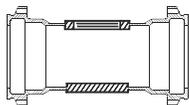

Size (in.)	Item No.	Crt. Qty.	List Price (\$)	Wt. (lb.)
4	CDPOTT04		288.00	27
6	CDPOTT06		379.00	38
8	CDPOTT08		560.00	59
10	CDPOTT10		670.00	72
12	CDPOTT12		843.00	92

**PO FLANGE ADAPTER**

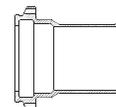

Size (in.)	Item No.	Crt. Qty.	List Price (\$)	Wt. (lb.)
4	CDPOFA04	80	196.00	22
6	CDPOFA06	48	306.00	34
8	CDPOFA08	36	411.00	50
10	CDPOFA10	24	520.00	70
12	CDPOFA12	16	816.00	80
14	CDPOFA14		1,481.00	113
16	CDPOFA16	8	1,640.00	180
18	CDPOFA18		2,379.00	226
20	CDPOFA20		2,612.00	264
24	CDPOFA24	4	5,119.00	308

**PO LATERAL WYES**

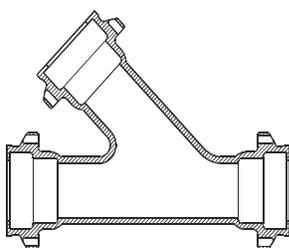

Size (in.)	Item No.	Crt. Qty.	List Price (\$)	Wt. (lb.)
4 X 4	CDPOL0404	8	308.00	55
6 X 4	CDPOL0604	8	704.00	75
6 X 6	CDPOL0606	8	870.00	83
8 X 4	CDPOL0804		877.00	90
8 X 6	CDPOL0806	8	1,197.00	125
8 X 8	CDPOL0808	8	1,426.00	140
10X 4	CDPOL1004		997.00	141
10X 6	CDPOL1006		1,302.00	155
10X 8	CDPOL1008		1,724.00	160
10X10	CDPOL1010	4	1,548.00	170
12X 4	CDPOL1204		1,646.00	178
12X 6	CDPOL1206		1,725.00	234
12X 8	CDPOL1208		1,889.00	260
12X10	CDPOL1210		2,077.00	280
12X12	CDPOL1212	3	2,018.00	300
14X 6	CDPOL1406		2,023.00	236
14X 8	CDPOL1408		2,186.00	255
14X10	CDPOL1410		2,784.00	325
14X14	CDPOL1414		4,067.00	475
16X 6	CDPOL1606		2,410.00	281
16X 8	CDPOL1608		2,604.00	304
16X12	CDPOL1612		2,961.00	346
16X16	CDPOL1616		3,254.00	380

**REDUCERS : PO X PO**

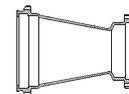

Size (in.)	Item No.	Crt. Qty.	List Price (\$)	Wt. (lb.)
6 X 4	CDPOR0604	60	226.00	30
8 X 4	CDPOR0804	36	324.00	40
8 X 6	CDPOR0806	36	329.00	40
10X 4	CDPOR1004		622.00	55
10X 6	CDPOR1006		486.00	60
10X 8	CDPOR1008	18	539.00	65
12X 4	CDPOR1204	12	684.00	70
12X 6	CDPOR1206	18	577.00	75
12X 8	CDPOR1208	12	627.00	80
12X10	CDPOR1210	12	751.00	107
14X 6	CDPOR1406		630.00	84
14X 8	CDPOR1408		639.00	85
14X10	CDPOR1410		655.00	87
14X12	CDPOR1412		779.00	104
16X 6	CDPOR1606	4	1,322.00	138
16X 8	CDPOR1608	4	1,371.00	137
16X10	CDPOR1610	4	1,342.00	130
16X12	CDPOR1612	4	1,416.00	135
16X14	CDPOR1614		1,194.00	139
18X 8	CDPOR1808		1,260.00	142
18X10	CDPOR1810		1,338.00	151
18X12	CDPOR1812		1,483.00	167
18X14	CDPOR1814		1,922.00	217

Contd.....

**REDUCERS : PO X PO**

Contd.....

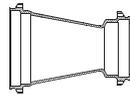

Size (in.)	Item No.	Crt. Qty.	List Price (\$)	Wt. (lb.)
18X16	CDPOR1816		1,790.00	202
20X10	CDPOR2010		1,595.00	180
20X12	CDPOR2012		1,817.00	205
20X14	CDPOR2014		2,061.00	233
20X16	CDPOR2016		2,213.00	250
20X18	CDPOR2018		2,195.00	248
24X12	CDPOR2412		2,178.00	337
24X14	CDPOR2414		2,489.00	339
24X16	CDPOR2416		3,360.00	340
24X18	CDPOR2418		3,449.00	390
24X20	CDPOR2420		3,722.00	421

**REDUCERS : PO X FE**

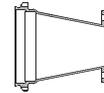

Size (in.)	Item No.	Crt. Qty.	List Price (\$)	Wt. (lb.)
6 X 4	CDPOFR0604	16	282.00	32
8 X 4	CDPOFR0804	16	427.00	46
8 X 6	CDPOFR0806	36	414.00	47
10X 4	CDPOFR1004		475.00	55
10X 6	CDPOFR1006	12	508.00	59
10X 8	CDPOFR1008	18	841.00	60
12X 4	CDPOFR1204		670.00	78
12X 6	CDPOFR1206	8	647.00	73
12X 8	CDPOFR1208	8	639.00	74
12X10	CDPOFR1210		818.00	95
14X 6	CDPOFR1406		1,040.00	121
14X 8	CDPOFR1408		1,101.00	128
14X10	CDPOFR1410		1,093.00	127
14X12	CDPOFR1412		1,237.00	144
16X 6	CDPOFR1606		1,143.00	136
16X 8	CDPOFR1608		1,212.00	144
16X10	CDPOFR1610		1,356.00	160
16X12	CDPOFR1612	4	1,475.00	170
16X14	CDPOFR1614		1,683.00	196
18X 8	CDPOFR1808		1,393.00	157
18X10	CDPOFR1810		1,552.00	175
18X12	CDPOFR1812		1,906.00	215
18X14	CDPOFR1814		2,072.00	234
18X16	CDPOFR1816		2,178.00	246
20X10	CDPOFR2010		2,072.00	234
20X14	CDPOFR2014		2,206.00	249
20X16	CDPOFR2016		2,406.00	272
24X12	CDPOFR2412		2,319.00	262
24X14	CDPOFR2414		2,785.00	315
24X16	CDPOFR2416		2,902.00	328

**PUSH-ON GASKET**

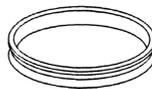

Size (in.)	Item No.	Crt. Qty.	List Price (\$)	Wt. (lb.)
4	6655.04	180	10.00	0.4
6	6655.06	100	12.00	0.6
8	6655.08	80	14.00	0.7
10	6655.1	60	21.00	0.9
12	6655.12	60	23.00	1
14	6655.14	60	47.00	1.3
16	6655.16	50	47.00	1.5
18			66.00	
20			71.00	
24			71.00	

**TRANSITION PUSH-ON GASKET**

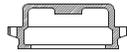

Size (in.)	Item No.	Crt. Qty.	List Price (\$)	Wt. (lb.)
4	6656.04	180	62.00	0.4
6	6656.06	100	68.00	0.6
8	6656.08	80	114.00	0.7
10	6656.10	60	139.00	0.9
12	6656.12	60	189.00	1.0

**PO CAPS SOLID**

Size (in.)	Item No.	Crt. Qty.	List Price (\$)	Wt. (lb.)
4	CDPOC04	120	101.00	13
6	CDPOC06	72	154.00	20
8	CDPOC08	54	237.00	32
10	CDPOC10	36	303.00	40
12	CDPOC12	24	443.00	63
14	CDPOC14		POA	70
16	CDPOC16	12	POA	110
18	CDPOC18		POA	120
20	CDPOC20		POA	150
24	CDPOC24	4	POA	216

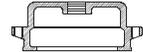
**PO CAPS TAPPED**

Size (in.)	Item No.	Crt. Qty.	List Price (\$)	Wt. (lb.)
4	CDPOCT04	120	152.00	13
6	CDPOCT06	72	206.00	20
8	CDPOCT08	54	288.00	32
10	CDPOCT10	36	356.00	40
12	CDPOCT12	24	492.00	63
14	CDPOCT14		POA	70
16	CDPOCT16	12	POA	110
18	CDPOCT18		POA	120
20	CDPOCT20		POA	150
24	CDPOCT24		POA	216

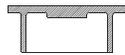
**PO PLUGS SOLID**

Size (in.)	Item No.	Crt. Qty.	List Price (\$)	Wt. (lb.)
4	CDPOP04	200	78.00	12
6	CDPOP06	96	126.00	18
8	CDPOP08	72	170.00	29
10	CDPOP10	36	264.00	35
12	CDPOP12	30	302.00	46
14	CDPOP14		1,046.00	74
16	CDPOP16	20	3,010.00	60
18	CDPOP18		2,874.00	120
20	CDPOP20		2,473.00	145
24	CDPOP24	4	3,478.00	204

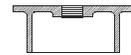
**PO PLUGS TAPPED**

Size (in.)	Item No.	Crt. Qty.	List Price (\$)	Wt. (lb.)
4	CDPOPT04	100	110.00	12
6	CDPOPT06	72	179.00	18
8	CDPOPT08	54	221.00	29
10	CDPOPT10	36	315.00	35
12	CDPOPT12	24	352.00	46
14	CDPOPT14		1,228.00	74
16	CDPOPT16	8	3,537.00	60
18	CDPOPT18		3,378.00	120
20	CDPOPT20		2,907.00	145
24	CDPOPT24	4	3,085.00	204

# Utility Pipe Fittings Zinc Coated

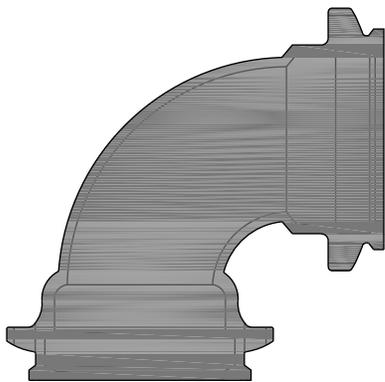

ANSI/AWWA C153/A21.53  
**COMPACT PUSH-ON FITTINGS**  
**ZINC COATED**

**PRICE LIST**  
**Effective June 01, 2021**



**BENDS : PO X PO  
90° (1/4)**

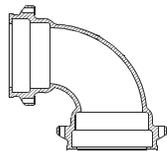

Size (in.)	Item No.	Crt. Qty.	List Price (\$)	Wt. (lb.)
4	CDPOB9004Z	60	278.00	28
6	CDPOB9006Z	32	443.00	44
8	CDPOB9008Z	18	656.00	71
10	CDPOB9010Z	12	860.00	100
12	CDPOB9012Z	6	1,421.00	140
14	CDPOB9014Z	0	2,067.00	254
16	CDPOB9016Z	4	3,694.00	280
18	CDPOB9018Z	0	5,002.00	482
20	CDPOB9020Z	0	5,598.00	640
24	CDPOB9024Z	2	6,988.00	710

**BENDS : PO X PO  
45° (1/8)**

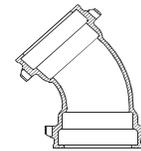

Size (in.)	Item No.	Crt. Qty.	List Price (\$)	Wt. (lb.)
4	CDPOB4504Z	75	253.00	23
6	CDPOB4506Z	36	376.00	38
8	CDPOB4508Z	27	549.00	54
10	CDPOB4510Z	18	821.00	84
12	CDPOB4512Z	8	1,095.00	110
14	CDPOB4514Z		1,638.00	150
16	CDPOB4516Z	4	2,585.00	210
18	CDPOB4518Z		2,914.00	309
20	CDPOB4520Z		4,117.00	397
24	CDPOB4524Z		5,104.00	455

**BENDS : PO X PO  
22½° (1/16)**

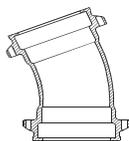

Size (in.)	Item No.	Crt. Qty.	List Price (\$)	Wt. (lb.)
4	CDPOB2204Z	75	242.00	22
6	CDPOB2206Z	48	334.00	34
8	CDPOB2208Z	27	467.00	55
10	CDPOB2210Z	18	695.00	70
12	CDPOB2212Z	8	930.00	90
14	CDPOB2214Z		1,638.00	162
16	CDPOB2216Z	4	2,406.00	220
18	CDPOB2218Z		3,181.00	209
20	CDPOB2220Z		4,297.00	414
24	CDPOB2224Z		5,858.00	455

**BENDS : PO X PO  
11¼° (1/32)**

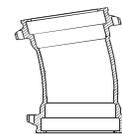

Size (in.)	Item No.	Crt. Qty.	List Price (\$)	Wt. (lb.)
4	CDPOB1104Z	75	238.00	21
6	CDPOB1106Z	48	328.00	32
8	CDPOB1108Z	25	457.00	52
10	CDPOB1110Z	18	676.00	70
12	CDPOB1112Z	8	900.00	95
14	CDPOB1114Z		1,638.00	113
16	CDPOB1116Z	4	2,437.00	170
18	CDPOB1118Z		3,200.00	209
20	CDPOB1120Z		3,897.00	265
24	CDPOB1124Z	2	7,752.00	315

**BENDS : PO X PE  
90° (1/4)**

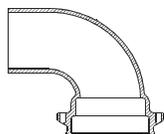

Size (in.)	Item No.	Crt. Qty.	List Price (\$)	Wt. (lb.)
4	CDPOPB9004Z	60	506.00	24
6	CDPOPB9006Z	32	480.00	48
8	CDPOPB9008Z		POA	

**BENDS : PO X PE  
45° (1/8)**

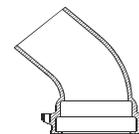

Size (in.)	Item No.	Crt. Qty.	List Price (\$)	Wt. (lb.)
4	CDPOPB4504Z	75	184.00	21
6	CDPOPB4506Z	36	388.00	38
8	CDPOPB4508Z	27	607.00	60

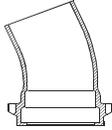
**BENDS : PO X PE  
22½° (1/16)**

Size (in.)	Item No.	Crt. Qty.	List Price (\$)	Wt. (lb.)
4	CDPOPB2204Z		POA	
6	CDPOPB2206Z	48	357.00	35
8	CDPOPB2208Z	27	577.00	57

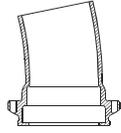
**BENDS : PO X PE  
11¼° (1/32)**

Size (in.)	Item No.	Crt. Qty.	List Price (\$)	Wt. (lb.)
4	CDPOPB1104Z		POA	
6	CDPOPB1106Z	48	366.00	35
8	CDPOPB1108Z	27	559.00	55

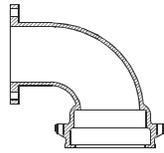
**BENDS : PO X FE  
90° (1/4)**

Size (in.)	Item No.	Crt. Qty.	List Price (\$)	Wt. (lb.)
4	CDPOFB9004Z	24	245.00	32
6	CDPOFB9006Z	36	615.00	49
8	CDPOFB9008Z	18	695.00	74
10	CDPOFB9010Z	16	1,154.00	130
12	CDPOFB9012Z	16	1,741.00	158
14	CDPOFB9014Z	0	1,601.00	231
16	CDPOFB9016Z	4	2,341.00	233

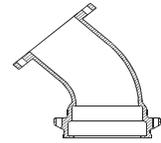
**BENDS : PO X FE  
45° (1/8)**

Size (in.)	Item No.	Crt. Qty.	List Price (\$)	Wt. (lb.)
4	CDPOFB4504Z	0	217.00	21
6	CDPOFB4506Z	36	473.00	42
8	CDPOFB4508Z	18	725.00	60
10	CDPOFB4510Z	0	939.00	93
12	CDPOFB4512Z	0	1,352.00	122
14	CDPOFB4514Z	0	1,631.00	162
16	CDPOFB4516Z	0	2,767.00	275

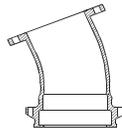
**BENDS : PO X FE  
22½° (1/16)**

Size (in.)	Item No.	Crt. Qty.	List Price (\$)	Wt. (lb.)
4	CDPOFB2204Z	48	271.00	25
6	CDPOFB2206Z	36	355.00	44
8	CDPOFB2208Z	24	588.00	64
10	CDPOFB2210Z	12	827.00	90
12	CDPOFB2212Z	8	1,342.00	112
14	CDPOFB2214Z		1,631.00	174
16	CDPOFB2215Z		2,767.00	228

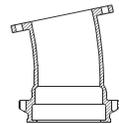
**BENDS : PO X FE  
11¼° (1/32)**

Size (in.)	Item No.	Crt. Qty.	List Price (\$)	Wt. (lb.)
4	CDPOFB1104Z	48	245.00	24
6	CDPOFB1106Z	36	355.00	30
8	CDPOFB1108Z	27	593.00	60
10	CDPOFB1110Z	12	775.00	80
12	CDPOFB1112Z	8	1,154.00	96
14	CDPOFB1114Z		1,713.00	170
16	CDPOFB1115Z		2,296.00	230

ZINC  
ZINC  
ZINC  
ZINC  
ZINC  
ZINC  
ZINC  
ZINC  
ZINC  
ZINC  
ZINC

**TEES : PO X PO**

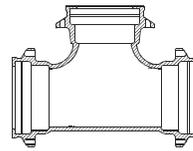

Size (in.)	Item No.	Crt. Qty.	List Price (\$)	Wt. (lb.)
4 X 4	CDPOT0404Z	48	394.00	46
6 X 4	CDPOT0604Z	24	499.00	58
6 X 6	CDPOT0606Z	24	555.00	66
8 X 4	CDPOT0804Z	16	668.00	93
8 X 6	CDPOT0806Z	18	758.00	103
8 X 8	CDPOT0808Z	18	903.00	109
10 X 4	CDPOT1004Z	18	1,023.00	95
10 X 6	CDPOT1006Z	12	1,120.00	129
10 X 8	CDPOT1008Z	8	1,315.00	141
10 X 10	CDPOT1010Z	8	1,631.00	145
12 X 4	CDPOT1204Z	12	1,270.00	115
12 X 6	CDPOT1206Z	8	1,189.00	164
12 X 8	CDPOT1208Z	8	1,445.00	166
12 X 10	CDPOT1210Z	4	1,647.00	175
12 X 12	CDPOT1212Z	4	1,631.00	193
14 X 6	CDPOT1406Z		1,609.00	176
14 X 10	CDPOT1410Z		3,265.00	195
14 X 12	CDPOT1412Z		3,309.00	196
14 X 14	CDPOT1414Z		3,479.00	209
16 X 6	CDPOT1606Z	2	3,012.00	231
16 X 8	CDPOT1608Z	4	3,275.00	265
16 X 10	CDPOT1610Z		3,409.00	232
16 X 12	CDPOT1612Z	4	3,879.00	300
16 X 14	CDPOT1614Z		4,850.00	349
16 X 16	CDPOT1616Z	4	4,633.00	261
18 X 6	CDPOT1806Z		3,612.00	348
18 X 8	CDPOT1808Z		3,373.00	325
18 X 10	CDPOT1810Z		3,570.00	344
18 X 12	CDPOT1812Z		POA	344
18 X 14	CDPOT1814Z		3,549.00	342
18 X 16	CDPOT1816Z		3,756.00	362
18 X 18	CDPOT1818Z		POA	377
20 X 6	CDPOT2006Z		3,684.00	355
20 X 10	CDPOT2010Z		3,831.00	369
20 X 12	CDPOT2012Z		POA	425
20 X 14	CDPOT2014Z		5,021.00	484
20 X 16	CDPOT2016Z		6,325.00	510
20 X 18	CDPOT2018Z		5,591.00	539
20 X 20	CDPOT2020Z		POA	564

Size (in.)	Item No.	Crt. Qty.	List Price (\$)	Wt. (lb.)
24 X 6	CDPOT2406Z		4,833.00	450
24 X 8	CDPOT2408Z		POA	492
24 X 10	CDPOT2410Z		4,960.00	478
24 X 12	CDPOT2412Z		6,875.00	541
24 X 14	CDPOT2414Z		5,619.00	542
24 X 16	CDPOT2416Z		5,869.00	566
24 X 18	CDPOT2418Z	2	6,150.00	593
24 X 20	CDPOT2420Z		6,512.00	628
24 X 24	CDPOT2424Z		9,166.00	884

**TEES : PO X FE**

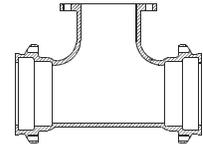

Size (in.)	Item No.	Crt. Qty.	List Price (\$)	Wt. (lb.)
4 X 4	CDPOFT0404Z	24	424.00	42
6 X 4	CDPOFT0604Z	24	545.00	59
6 X 6	CDPOFT0606Z	24	575.00	67
8 X 4	CDPOFT0804Z	18	732.00	79
8 X 6	CDPOFT0806Z	18	758.00	85
8 X 8	CDPOFT0808Z	18	919.00	105
10 X 4	CDPOFT1004Z	18	980.00	97
10 X 6	CDPOFT1006Z	8	1,265.00	102
10 X 8	CDPOFT1008Z	8	1,406.00	128
10 X 10	CDPOFT1010Z	8	1,433.00	165
12 X 4	CDPOFT1204Z	12	1,260.00	125
12 X 6	CDPOFT1206Z	8	1,291.00	135
12 X 8	CDPOFT1208Z	8	1,491.00	155
12 X 10	CDPOFT1210Z	4	1,516.00	142
12 X 12	CDPOFT1212Z	4	2,128.00	210
14 X 6	CDPOFT1406Z		2,547.00	212
14 X 8	CDPOFT1408Z		POA	265
14 X 10	CDPOFT1410Z		3,239.00	246
14 X 12	CDPOFT1412Z		3,861.00	296
14 X 14	CDPOFT1414Z		4,175.00	321
16 X 6	CDPOFT1606Z	8	2,732.00	236
16 X 8	CDPOFT1608Z	8	3,385.00	269
16 X 10	CDPOFT1610Z		3,317.00	330

Contd.....

**TEES : PO X FE**  
Contd.....

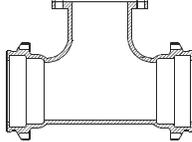

Size (in.)	Item No.	Crt. Qty.	List Price (\$)	Wt. (lb.)
16 X 12	CDPOFT1612Z	4	3,226.00	348
16 X 14	CDPOFT1614Z		4,433.00	342
16 X 16	CDPOFT1616Z	4	4,598.00	355
18 X 6	CDPOFT1806Z		3,123.00	301
18 X 8	CDPOFT1808Z		3,310.00	319
18 X 10	CDPOFT1810Z		3,495.00	337
18 X 14	CDPOFT1814Z		4,075.00	393
18 X 16	CDPOFT1816Z		4,356.00	420
20 X 6	CDPOFT2006Z		3,537.00	341
20 X 10	CDPOFT2010Z		4,024.00	420
20 X 14	CDPOFT2014Z		5,130.00	474
20 X 16	CDPOFT2016Z		5,389.00	498
20 X 18	CDPOFT2018Z		POA	528
24 X 6	CDPOFT2406Z		5,534.00	512
24 X 8	CDPOFT2408Z		POA	594
24 X 10	CDPOFT2410Z		5,062.00	468
24 X 12	CDPOFT2412Z		5,440.00	503
24 X 14	CDPOFT2414Z		5,741.00	531
24 X 16	CDPOFT2416Z		6,002.00	555

**HYDRANT TEES : PO X SWIVEL**

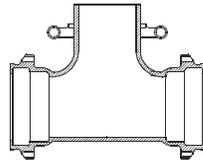

Size (in.)	Item No.	Crt. Qty.	List Price (\$)	Wt. (lb.)
6 X 6	CDPOHT0606Z	24	604.00	70
8 X 6	CDPOHT0806Z	24	1,005.00	90
8 X 8	CDPOHT0808Z		1,107.00	110
10X 6	CDPOHT1006Z		1,309.00	100
10X 8	CDPOHT1008Z		1,571.00	156
12X 6	CDPOHT1206Z	16	1,591.00	138
12X 8	CDPOHT1208Z		1,592.00	158
14X 6	CDPOHT1406Z		2,034.00	202
16X 6	CDPOHT1606Z	2	2,304.00	230
16X 8	CDPOHT1608Z		2,934.00	292
18X 6	CDPOHT1806Z		3,612.00	348
18X 8	CDPOHT1808Z		3,362.00	324
20X 6	CDPOHT2006Z		4,148.00	400
24X 6	CDPOHT2406Z		5,444.00	525

**PO CROSSES**

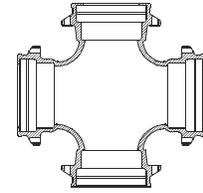

Size (in.)	Item No.	Crt. Qty.	List Price (\$)	Wt. (lb.)
4 X 4	CDPOX0404Z		POA	56
6 X 4	CDPOX0604Z		POA	69
6 X 6	CDPOX0606Z	12	684.00	83
8 X 4	CDPOX0804Z		POA	117
8 X 6	CDPOX0806Z	12	1,015.00	115
8 X 8	CDPOX0808Z	12	1,154.00	128
10 X 4	CDPOX1004Z		1,275.00	116
10 X 6	CDPOX1006Z		POA	
10 X 8	CDPOX1008Z		POA	159
10 X 10	CDPOX1010Z		POA	165
12 X 8	CDPOX1208Z	8	1,614.00	197
12 X 10	CDPOX1210Z		POA	195
12 X 12	CDPOX1212Z		2,185.00	241
14 X 6	CDPOX1406Z		1,686.00	189
14 X 8	CDPOX1408Z		2,051.00	204
14 X 10	CDPOX1410Z		2,233.00	222
14 X 12	CDPOX 1412Z		2,405.00	239
14 X 14	CDPOX1414Z		2,714.00	270
16 X 6	CDPOX1606Z		2,377.00	234
16 X 8	CDPOX1608Z		3,246.00	323
16 X 10	CDPOX1610Z		POA	268
16 X 12	CDPOX1612Z		2,757.00	274
16 X 14	CDPOX 1614Z		POA	322
16 X 16	CDPOX1616Z		3,190.00	317
24 X 24	CDPOX2424Z		POA	1178

**TEES : PO X PE**

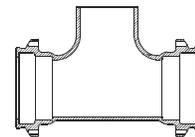

Size (in.)	Item No.	Crt. Qty.	List Price (\$)	Wt. (lb.)
6 X 6	CDPOPET0606Z	24	745.00	60
8 X 6	CDPOPET0806Z	18	1132.00	75
12X 6	CDPOPET1206Z	8	1,673.00	132

**TEES : PO TAPPED 2"**

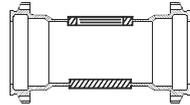

Size (in.)	Item No.	Crt. Qty.	List Price (\$)	Wt. (lb.)
4	CDCDPOTT04Z		324.00	27
6	CDCDPOTT06Z		431.00	38
8	CDCDPOTT08Z		639.00	59
10	CDCDPOTT10Z		762.00	72
12	CDCDPOTT12Z		969.00	92

**PO FLANGE ADAPTER**

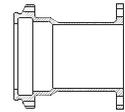

Size (in.)	Item No.	Crt. Qty.	List Price (\$)	Wt. (lb.)
4	CDPOFA04Z	80	246.00	22
6	CDPOFA06Z	48	378.00	34
8	CDPOFA08Z	36	522.00	50
10	CDPOFA10Z	24	657.00	70
12	CDPOFA12Z	16	1,002.00	80
14	CDPOFA14Z		1,740.00	113
16	CDPOFA16Z	8	1,975.00	180
18	CDPOFA18Z		2,777.00	226
20	CDPOFA20Z		3,063.00	264
24	CDPOFA24Z	4	5,591.00	308

**PO LATERAL WYES**

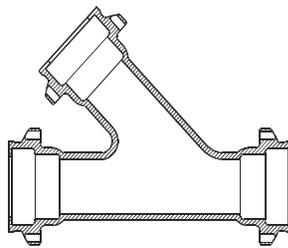

Size (in.)	Item No.	Crt. Qty.	List Price (\$)	Wt. (lb.)
4 X 4	CDPOL0404Z	8	POA	55
6 X 4	CDPOL0604Z	8	POA	75
6 X 6	CDPOL0606Z	8	POA	83
8 X 4	CDPOL0804Z		1,012.00	90
8 X 6	CDPOL0806Z	8	POA	125
8 X 8	CDPOL0808Z	8	POA	140
10X 4	CDPOL1004Z		1,205.00	141
10X 6	CDPOL1006Z		1,527.00	155
10X 8	CDPOL1008Z		1,983.00	160
10X10	CDPOL1010Z	4	1,845.00	170
12X 4	CDPOL1204Z		1,912.00	178
12X 6	CDPOL1206Z		2,023.00	234
12X 8	CDPOL1208Z		2,219.00	260
12X10	CDPOL1210Z		2,432.00	280
12X12	CDPOL1212Z	3	2,447.00	300
14X 6	CDPOL1406Z		2,373.00	236
14X 8	CDPOL1408Z		2,564.00	255
14X10	CDPOL1410Z		3,267.00	325
14X14	CDPOL1414Z		4,770.00	475
16X 6	CDPOL1606Z		2,826.00	281
16X 8	CDPOL1608Z		3,056.00	304
16X12	CDPOL1612Z		3,476.00	346
16X16	CDPOL1616Z		3,817.00	380

**REDUCERS : PO X PO**

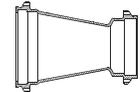

Size (in.)	Item No.	Crt. Qty.	List Price (\$)	Wt. (lb.)
6 X 4	CDPOR0604Z	60	277.00	30
8 X 4	CDPOR0804Z	36	393.00	40
8 X 6	CDPOR0806Z	36	404.00	40
10X 4	CDPOR1004Z		748.00	55
10X 6	CDPOR1006Z		582.00	60
10X 8	CDPOR1008Z	18	645.00	65
12X 4	CDPOR1204Z	12	821.00	70
12X 6	CDPOR1206Z	18	693.00	75
12X 8	CDPOR1208Z	12	750.00	80
12X10	CDPOR1210Z	12	898.00	107
14X 6	CDPOR1406Z		754.00	84
14X 8	CDPOR1408Z		764.00	85
14X10	CDPOR1410Z		784.00	87
14X12	CDPOR1412Z		933.00	104
16X 6	CDPOR1606Z	4	1,587.00	138
16X 8	CDPOR1608Z	4	1,646.00	137
16X10	CDPOR1610Z	4	1,609.00	130
16X12	CDPOR1612Z	4	1,698.00	135
16X14	CDPOR1614Z		1,400.00	139
18X 8	CDPOR1808Z		1,479.00	142
18X10	CDPOR1810Z		1,569.00	151
18X12	CDPOR1812Z		1,740.00	167
18X14	CDPOR1814Z		2,256.00	217

Contd.....

**REDUCERS : PO X PO**

Contd.....

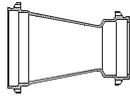

Size (in.)	Item No.	Crt. Qty.	List Price (\$)	Wt. (lb.)
18X16	CDPOR1816Z		2,100.00	202
20X10	CDPOR2010Z		1,869.00	180
20X12	CDPOR2012Z		2,131.00	205
20X14	CDPOR2014Z		2,417.00	233
20X16	CDPOR2016Z		2,595.00	250
20X18	CDPOR2018Z		2,576.00	248
24X12	CDPOR2412Z		2,554.00	337
24X14	CDPOR2414Z		2,917.00	339
24X16	CDPOR2416Z		3,941.00	340
24X18	CDPOR2418Z		4,046.00	390
24X20	CDPOR2420Z		4,367.00	421

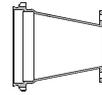
**REDUCERS : PO X FE**

Size (in.)	Item No.	Crt. Qty.	List Price (\$)	Wt. (lb.)
6 X 4	CDPOFR0604Z	16	341.00	32
8 X 4	CDPOFR0804Z	16	496.00	46
8 X 6	CDPOFR0806Z	36	501.00	47
10X 4	CDPOFR1004Z		559.00	55
10X 6	CDPOFR1006Z	12	598.00	59
10X 8	CDPOFR1008Z	18	946.00	60
12X 4	CDPOFR1204Z		788.00	78
12X 6	CDPOFR1206Z	8	761.00	73
12X 8	CDPOFR1208Z	8	748.00	74
12X10	CDPOFR1210Z		960.00	95
14X 6	CDPOFR1406Z		1,221.00	121
14X 8	CDPOFR1408Z		1,291.00	128
14X10	CDPOFR1410Z		1,282.00	127
14X12	CDPOFR1412Z		1,451.00	144
16X 6	CDPOFR1606Z		1,340.00	136
16X 8	CDPOFR1608Z		1,421.00	144
16X10	CDPOFR1610Z		1,592.00	160
16X12	CDPOFR1612Z	4	1,730.00	170
16X14	CDPOFR1614Z		1,973.00	196
18X 8	CDPOFR1808Z		1,634.00	157
18X10	CDPOFR1810Z		1,821.00	175
18X12	CDPOFR1812Z		2,234.00	215
18X14	CDPOFR1814Z		2,430.00	234
18X16	CDPOFR1816Z		2,554.00	246
20X10	CDPOFR2010Z		2,430.00	234
20X14	CDPOFR2014Z		2,588.00	249
20X16	CDPOFR2016Z		2,823.00	272
24X12	CDPOFR2412Z		2,721.00	262
24X14	CDPOFR2414Z		3,269.00	315
24X16	CDPOFR2416Z		3,406.00	328

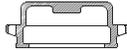
**PO CAPS SOLID**

Size (in.)	Item No.	Crt. Qty.	List Price (\$)	Wt. (lb.)
4	CDPOC04Z	120	123.00	13
6	CDPOC06Z	72	185.00	20
8	CDPOC08Z	54	286.00	32
10	CDPOC10Z	36	377.00	40
12	CDPOC12Z	24	529.00	63
14	CDPOC14Z		POA	70
16	CDPOC16Z	12	POA	110
18	CDPOC18Z		POA	120
20	CDPOC20Z		POA	150
24	CDPOC24Z	4	POA	216

ZINC

ZINC

ZINC

ZINC

ZINC

ZINC

**PO CAPS TAPPED**

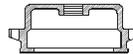

Size (in.)	Item No.	Crt. Qty.	List Price (\$)	Wt. (lb.)
4	CDPOCT04Z	120	175.00	13
6	CDPOCT06Z	72	238.00	20
8	CDPOCT08Z	54	339.00	32
10	CDPOCT10Z	36	430.00	40
12	CDPOCT12Z	24	581.00	63
14	CDPOCT14Z		POA	70
16	CDPOCT16Z	12	POA	110
18	CDPOCT18Z		POA	120
20	CDPOCT20Z		POA	150
24	CDPOCT24Z		POA	216

**PO PLUGS SOLID**

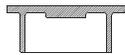

**PO PLUGS TAPPED**

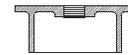

Size (in.)	Item No.	Crt. Qty.	List Price (\$)	Wt. (lb.)
4	CDPOP04Z	200	94.00	12
6	CDPOP06Z	96	159.00	18
8	CDPOP08Z	72	218.00	29
10	CDPOP10Z	36	326.00	35
12	CDPOP12Z	30	377.00	46
14	CDPOP14Z		POA	74
16	CDPOP16Z	20	POA	60
18	CDPOP18Z		POA	120
20	CDPOP20Z		POA	145
24	CDPOP24Z	4	POA	204

Size (in.)	Item No.	Crt. Qty.	List Price (\$)	Wt. (lb.)
4	CDPOPT04Z	100	126.00	12
6	CDPOPT06Z	72	212.00	18
8	CDPOPT08Z	54	270.00	29
10	CDPOPT10Z	36	379.00	35
12	CDPOPT12Z	24	427.00	46
14	CDPOPT14Z		POA	74
16	CDPOPT16Z	8	POA	60
18	CDPOPT18Z		POA	120
20	CDPOPT20Z		POA	145
24	CDPOPT24Z	4	POA	204

# Utility Pipe Fittings Fusion Bonded Epoxy

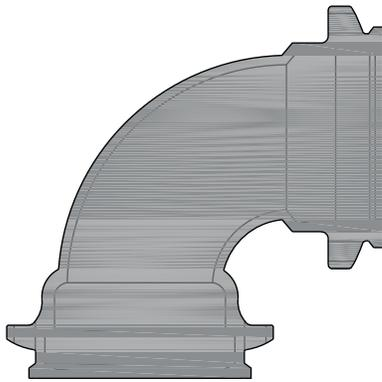

ANSI/AWWA C153/A21.53  
**COMPACT PUSH-ON FITTINGS**  
**FUSION BONDED EPOXY**

**PRICE LIST**  
Effective June 01, 2021



**BENDS : PO X PO  
90° (1/4)**

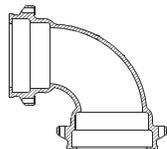

Size (in.)	Item No.	Crt. Qty.	List Price (\$)	Wt. (lb.)
4	CDPOB9004E	60	334.00	28
6	CDPOB9006E	32	532.00	44
8	CDPOB9008E	18	788.00	71
10	CDPOB9010E	12	1,032.00	100
12	CDPOB9012E	6	1,706.00	140
14	CDPOB9014E	0	2,481.00	254
16	CDPOB9016E	4	4,433.00	280
18	CDPOB9018E	0	6,003.00	482
20	CDPOB9020E	0	6,718.00	640
24	CDPOB9024E	2	8,386.00	710

**BENDS : PO X PO  
45° (1/8)**

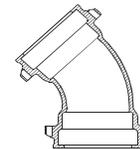

Size (in.)	Item No.	Crt. Qty.	List Price (\$)	Wt. (lb.)
4	CDPOB4504E	75	304.00	23
6	CDPOB4506E	36	452.00	38
8	CDPOB4508E	27	659.00	54
10	CDPOB4510E	18	986.00	84
12	CDPOB4512E	8	1,314.00	110
14	CDPOB4514E		1,966.00	150
16	CDPOB4516E	4	3,102.00	210
18	CDPOB4518E		3,497.00	309
20	CDPOB4520E		4,941.00	397
24	CDPOB4524E		6,125.00	455

**BENDS : PO X PO  
22½° (1/16)**

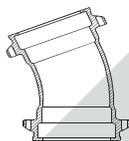

Size (in.)	Item No.	Crt. Qty.	List Price (\$)	Wt. (lb.)
4	CDPOB2204E	75	291.00	22
6	CDPOB2206E	48	401.00	34
8	CDPOB2208E	27	561.00	55
10	CDPOB2210E	18	834.00	70
12	CDPOB2212E	8	1,116.00	90
14	CDPOB2214E		1,966.00	162
16	CDPOB2216E	4	2,888.00	220
18	CDPOB2218E		3,818.00	209
20	CDPOB2220E		5,157.00	414
24	CDPOB2224E		7,030.00	455

**BENDS : PO X PO  
11¼° (1/32)**

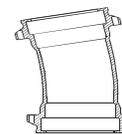

Size (in.)	Item No.	Crt. Qty.	List Price (\$)	Wt. (lb.)
4	CDPOB1104E	75	286.00	21
6	CDPOB1106E	48	394.00	32
8	CDPOB1108E	25	549.00	52
10	CDPOB1110E	18	812.00	70
12	CDPOB1112E	8	1,080.00	95
14	CDPOB1114E		1,966.00	113
16	CDPOB1116E	4	2,925.00	170
18	CDPOB1118E		3,840.00	209
20	CDPOB1120E		4,677.00	265
24	CDPOB1124E	2	9,303.00	315

**BENDS : PO X PE  
90° (1/4)**

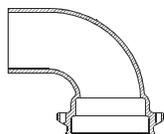

Size (in.)	Item No.	Crt. Qty.	List Price (\$)	Wt. (lb.)
4	CDPOPB9004E	60	608.00	24
6	CDPOPB9006E	32	576.00	48
8	CDPOPB9008E		POA	

**BENDS : PO X PE  
45° (1/8)**

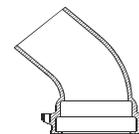

Size (in.)	Item No.	Crt. Qty.	List Price (\$)	Wt. (lb.)
4	CDPOPB4504E	75	221.00	21
6	CDPOPB4506E	36	466.00	38
8	CDPOPB4508E	27	729.00	60

CALL FOR BARE/BARE FITTINGS

**BENDS : PO X PE**  
**22½° (1/16)**

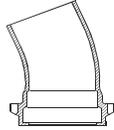

Size (in.)	Item No.	Crt. Qty.	List Price (\$)	Wt. (lb.)
4	CDPOPB2204E		POA	
6	CDPOPB2206E	48	429.00	35
8	CDPOPB2208E	27	693.00	57

**BENDS : PO X PE**  
**11¼° (1/32)**

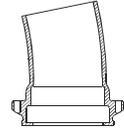

Size (in.)	Item No.	Crt. Qty.	List Price (\$)	Wt. (lb.)
4	CDPOPB1104E		POA	
6	CDPOPB1106E	48	440.00	35
8	CDPOPB1108E	27	671.00	55

**BENDS : PO X FE**  
**90° (1/4)**

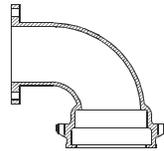

Size (in.)	Item No.	Crt. Qty.	List Price (\$)	Wt. (lb.)
4	CDPOFB9004E	24	294.00	32
6	CDPOFB9006E	36	738.00	49
8	CDPOFB9008E	18	834.00	74
10	CDPOFB9010E	16	1,385.00	130
12	CDPOFB9012E	16	2,090.00	158
14	CDPOFB9014E	0	1,922.00	231
16	CDPOFB9016E	4	2,810.00	233

**BENDS : PO X FE**  
**45° (1/8)**

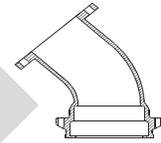

Size (in.)	Item No.	Crt. Qty.	List Price (\$)	Wt. (lb.)
4	CDPOFB4504E	0	261.00	21
6	CDPOFB4506E	36	568.00	42
8	CDPOFB4508E	18	870.00	60
10	CDPOFB4510E	0	1,127.00	93
12	CDPOFB4512E	0	1,623.00	122
14	CDPOFB4514E	0	1,958.00	162
16	CDPOFB4516E	0	3,321.00	275

**BENDS : PO X FE**  
**22½° (1/16)**

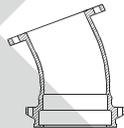

Size (in.)	Item No.	Crt. Qty.	List Price (\$)	Wt. (lb.)
4	CDPOFB2204E	48	326.00	25
6	CDPOFB2206E	36	426.00	44
8	CDPOFB2208E	24	706.00	64
10	CDPOFB2210E	12	993.00	90
12	CDPOFB2212E	8	1,611.00	112
14	CDPOFB2214E		1,958.00	174
16	CDPOFB2216E		3,321.00	228

**BENDS : PO X FE**  
**11¼° (1/32)**

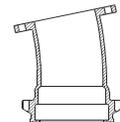

Size (in.)	Item No.	Crt. Qty.	List Price (\$)	Wt. (lb.)
4	CDPOFB1104E	48	294.00	24
6	CDPOFB1106E	36	426.00	30
8	CDPOFB1108E	27	712.00	60
10	CDPOFB1110E	12	930.00	80
12	CDPOFB1112E	8	1,385.00	96
14	CDPOFB1114E		2,056.00	170
16	CDPOFB1116E		2,756.00	230

CALL FOR BARE/BARE FITTINGS

**TEES : PO X PO**

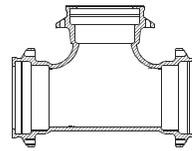

Size (in.)	Item No.	Crt. Qty.	List Price (\$)	Wt. (lb.)
4 X 4	CDPOT0404E	48	473.00	46
6 X 4	CDPOT0604E	24	599.00	58
6 X 6	CDPOT0606E	24	666.00	66
8 X 4	CDPOT0804E	16	802.00	93
8 X 6	CDPOT0806E	18	910.00	103
8 X 8	CDPOT0808E	18	1,084.00	109
10 X 4	CDPOT1004E	18	1,228.00	95
10 X 6	CDPOT1006E	12	1,344.00	129
10 X 8	CDPOT1008E	8	1,578.00	141
10 X 10	CDPOT1010E	8	1,958.00	145
12 X 4	CDPOT1204E	12	1,524.00	115
12 X 6	CDPOT1206E	8	1,427.00	164
12 X 8	CDPOT1208E	8	1,734.00	166
12 X 10	CDPOT1210E	4	1,977.00	175
12 X 12	CDPOT1212E	4	1,958.00	193
14 X 6	CDPOT1406E		1,931.00	176
14 X 10	CDPOT1410E		3,918.00	195
14 X 12	CDPOT1412E		3,971.00	196
14 X 14	CDPOT1414E		4,175.00	209
16 X 6	CDPOT1606E	2	3,615.00	231
16 X 8	CDPOT1608E	4	3,930.00	265
16 X 10	CDPOT1610E		4,091.00	232
16 X 12	CDPOT1612E	4	4,655.00	300
16 X 14	CDPOT1614E		5,820.00	349
16 X 16	CDPOT1616E	4	5,560.00	261
18 X 6	CDPOT1806E		4,335.00	348
18 X 8	CDPOT1808E		4,048.00	325
18 X 10	CDPOT1810E		4,284.00	344
18 X 12	CDPOT1812E		POA	344
18 X 14	CDPOT1814E		4,259.00	342
18 X 16	CDPOT1816E		4,508.00	362
18 X 18	CDPOT1818E		POA	377
20 X 6	CDPOT2006E		4,421.00	355
20 X 10	CDPOT2010E		4,598.00	369
20 X 12	CDPOT2012E		POA	425
20 X 14	CDPOT2014E		6,026.00	484
20 X 16	CDPOT2016E		7,590.00	510
20 X 18	CDPOT2018E		6,710.00	539
20 X 20	CDPOT2020E		POA	564

Size (in.)	Item No.	Crt. Qty.	List Price (\$)	Wt. (lb.)
24 X 6	CDPOT2406E		5,800.00	450
24 X 8	CDPOT2408E		POA	492
24 X 10	CDPOT2410E		5,952.00	478
24 X 12	CDPOT2412E		8,250.00	541
24 X 14	CDPOT2414E		6,743.00	542
24 X 16	CDPOT2416E		7,043.00	566
24 X 18	CDPOT2418E	2	7,380.00	593
24 X 20	CDPOT2420E		7,815.00	628
24 X 24	CDPOT2424E		11,000.00	884

**TEES : PO X FE**

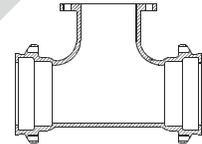

Size (in.)	Item No.	Crt. Qty.	List Price (\$)	Wt. (lb.)
4 X 4	CDPOFT0404E	24	509.00	42
6 X 4	CDPOFT0604E	24	654.00	59
6 X 6	CDPOFT0606E	24	690.00	67
8 X 4	CDPOFT0804E	18	879.00	79
8 X 6	CDPOFT0806E	18	910.00	85
8 X 8	CDPOFT0808E	18	1,103.00	105
10 X 4	CDPOFT1004E	18	1,176.00	97
10 X 6	CDPOFT1006E	8	1,518.00	102
10 X 8	CDPOFT1008E	8	1,688.00	128
10 X 10	CDPOFT1010E	8	1,720.00	165
12 X 4	CDPOFT1204E	12	1,512.00	125
12 X 6	CDPOFT1206E	8	1,550.00	135
12 X 8	CDPOFT1208E	8	1,790.00	155
12 X 10	CDPOFT1210E	4	1,820.00	142
12 X 12	CDPOFT1212E	4	2,554.00	210
14 X 6	CDPOFT1406E		3,057.00	212
14 X 8	CDPOFT1408E		4,316.00	265
14 X 10	CDPOFT1410E		3,887.00	246
14 X 12	CDPOFT1412E		4,634.00	296
14 X 14	CDPOFT1414E		5,010.00	321
16 X 6	CDPOFT1606E	8	3,279.00	236
16 X 8	CDPOFT1608E	8	4,062.00	269
16 X 10	CDPOFT1610E		3,981.00	330

CALL FOR BARE/BARE FITTINGS

Contd.....

**TEES : PO X FE**  
Contd.....

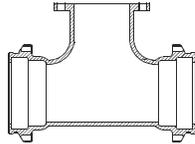

Size (in.)	Item No.	Crt. Qty.	List Price (\$)	Wt. (lb.)
16 X 12	CDPOFT1612E	4	3,872.00	348
16 X 14	CDPOFT1614E		5,320.00	342
16 X 16	CDPOFT1616E	4	5,518.00	355
18 X 6	CDPOFT1806E		3,748.00	301
18 X 8	CDPOFT1808E		3,972.00	319
18 X 10	CDPOFT1810E		4,194.00	337
18 X 14	CDPOFT1814E		4,890.00	393
18 X 16	CDPOFT1816E		5,228.00	420
20 X 6	CDPOFT2006E		4,245.00	341
20 X 10	CDPOFT2010E		5,452.00	420
20 X 14	CDPOFT2014E		6,156.00	474
20 X 16	CDPOFT2016E		6,467.00	498
20 X 18	CDPOFT2018E		9,822.00	528
24 X 6	CDPOFT2406E		6,641.00	512
24 X 8	CDPOFT2408E		8,526.00	594
24 X 10	CDPOFT2410E		6,075.00	468
24 X 12	CDPOFT2412E		6,528.00	503
24 X 14	CDPOFT2414E		6,890.00	531
24 X 16	CDPOFT2416E		7,203.00	555

**HYDRANT TEES : PO X SWIVEL**

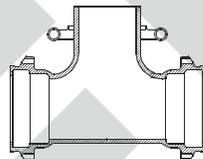

Size (in.)	Item No.	Crt. Qty.	List Price (\$)	Wt. (lb.)
6 X 6	CDPOHT0606E	24	725.00	70
8 X 6	CDPOHT0806E	24	1,206.00	90
8 X 8	CDPOHT0808E		1,329.00	110
10X 6	CDPOHT1006E		1,571.00	100
10X 8	CDPOHT1008E		1,886.00	156
12X 6	CDPOHT1206E	16	1,910.00	138
12X 8	CDPOHT1208E		1,911.00	158
14X 6	CDPOHT1406E		2,441.00	202
16X 6	CDPOHT1606E	2	2,765.00	230
16X 8	CDPOHT1608E		3,521.00	292
18X 6	CDPOHT1806E		4,335.00	348
18X 8	CDPOHT1808E		4,035.00	324
20X 6	CDPOHT2006E		4,978.00	400
24X 6	CDPOHT2406E		6,533.00	525

**PO CROSSES**

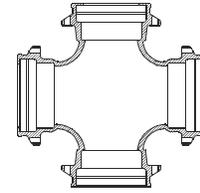

Size (in.)	Item No.	Crt. Qty.	List Price (\$)	Wt. (lb.)
4 X 4	CDPOX0404E		725.00	56
6 X 4	CDPOX0604E		863.00	69
6 X 6	CDPOX0606E	12	821.00	83
8 X 4	CDPOX0804E		1,510.00	117
8 X 6	CDPOX0806E	12	1,218.00	115
8 X 8	CDPOX0808E	12	1,385.00	128
10 X 4	CDPOX1004E		1,530.00	116
10 X 6	CDPOX1006E		2,194.00	
10 X 8	CDPOX1008E		2,628.00	159
10 X 10	CDPOX1010E		2,180.00	165
12 X 8	CDPOX1208E	8	1,937.00	197
12 X 10	CDPOX1210E		2,489.00	195
12 X 12	CDPOX1212E		2,622.00	241
14 X 6	CDPOX1406E		2,284.00	189
14 X 8	CDPOX1408E		2,462.00	204
14 X 10	CDPOX1410E		2,680.00	222
14 X 12	CDPOX 1412E		2,886.00	239
14 X 14	CDPOX1414E		3,257.00	270
16 X 6	CDPOX1606E		2,853.00	234
16 X 8	CDPOX1608E		3,896.00	323
16 X 10	CDPOX1610E		POA	268
16 X 12	CDPOX1612E		3,309.00	274
16 X 14	CDPOX 1614E		POA	322
16 X 16	CDPOX1616E		3,828.00	317
24 X 24	CDPOX2424E		POA	1178

**TEES : PO X PE**

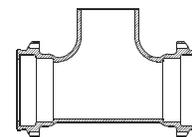

Size (in.)	Item No.	Crt. Qty.	List Price (\$)	Wt. (lb.)
6 X 6	CDPOPET0606E	24	745.00	60
8 X 6	CDPOPET0806E	18	1132.00	75
12X 6	CDPOPET1206E	8	1673.00	132

CALL FOR BARE/BARE FITTINGS

**TEES : PO TAPPED 2"**

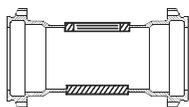

Size (in.)	Item No.	Crt. Qty.	List Price (\$)	Wt. (lb.)
4	CDCDPOTT04E		389.00	27
6	CDCDPOTT06E		518.00	38
8	CDCDPOTT08E		767.00	59
10	CDCDPOTT10E		915.00	72
12	CDCDPOTT12E		1163.00	92

**PO FLANGE ADAPTER**

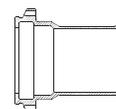

Size (in.)	Item No.	Crt. Qty.	List Price (\$)	Wt. (lb.)
4	CDPOFA04E	80	296.00	22
6	CDPOFA06E	48	454.00	34
8	CDPOFA08E	36	627.00	50
10	CDPOFA10E	24	789.00	70
12	CDPOFA12E	16	1,203.00	80
14	CDPOFA14E		2,088.00	113
16	CDPOFA16E	8	2,370.00	180
18	CDPOFA18E		3,333.00	226
20	CDPOFA20E		3,676.00	264
24	CDPOFA24E	4	6,710.00	308

**PO LATERAL WYES**

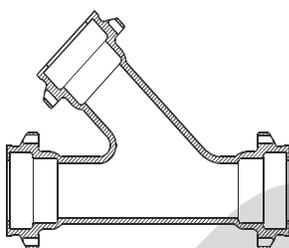

Size (in.)	Item No.	Crt. Qty.	List Price (\$)	Wt. (lb.)
4 X 4	CDPOL0404E	8	461.00	55
6 X 4	CDPOL0604E	8	981.00	75
6 X 6	CDPOL0606E	8	1,197.00	83
8 X 4	CDPOL0804E		1,215.00	90
8 X 6	CDPOL0806E	8	1,649.00	125
8 X 8	CDPOL0808E	8	1,936.00	140
10X 4	CDPOL1004E		1,446.00	141
10X 6	CDPOL1006E		1,833.00	155
10X 8	CDPOL1008E		2,380.00	160
10X10	CDPOL1010E	4	2,214.00	170
12X 4	CDPOL1204E		2,295.00	178
12X 6	CDPOL1206E		2,428.00	234
12X 8	CDPOL1208E		2,663.00	260
12X10	CDPOL1210E		2,919.00	280
12X12	CDPOL1212E	3	2,937.00	300
14X 6	CDPOL1406E		2,848.00	236
14X 8	CDPOL1408E		3,077.00	255
14X10	CDPOL1410E		3,921.00	325
14X14	CDPOL1414E		5,724.00	475
16X 6	CDPOL1606E		3,392.00	281
16X 8	CDPOL1608E		3,668.00	304
16X12	CDPOL1612E		4,172.00	346
16X16	CDPOL1616E		4,581.00	380

**REDUCERS : PO X PO**

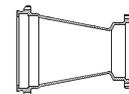

Size (in.)	Item No.	Crt. Qty.	List Price (\$)	Wt. (lb.)
6 X 4	CDPOR0604E	60	333.00	30
8 X 4	CDPOR0804E	36	472.00	40
8 X 6	CDPOR0806E	36	485.00	40
10X 4	CDPOR1004E		898.00	55
10X 6	CDPOR1006E		699.00	60
10X 8	CDPOR1008E	18	774.00	65
12X 4	CDPOR1204E	12	986.00	70
12X 6	CDPOR1206E	18	832.00	75
12X 8	CDPOR1208E	12	900.00	80
12X10	CDPOR1210E	12	1,078.00	107
14X 6	CDPOR1406E		905.00	84
14X 8	CDPOR1408E		917.00	85
14X10	CDPOR1410E		941.00	87
14X12	CDPOR1412E		1,120.00	104
16X 6	CDPOR1606E	4	1,905.00	138
16X 8	CDPOR1608E	4	1,976.00	137
16X10	CDPOR1610E	4	1,931.00	130
16X12	CDPOR1612E	4	2,038.00	135
16X14	CDPOR1614E		1,680.00	139
18X 8	CDPOR1808E		1,775.00	142
18X10	CDPOR1810E		1,883.00	151
18X12	CDPOR1812E		2,088.00	167
18X14	CDPOR1814E		2,708.00	217

CALL FOR BARE/BARE FITTINGS

Contd.....

**REDUCERS : PO X PO**

Contd.....

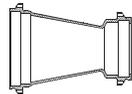

Size (in.)	Item No.	Crt. Qty.	List Price (\$)	Wt. (lb.)
18X16	CDPOR1816E		2,520.00	202
20X10	CDPOR2010E		2,243.00	180
20X12	CDPOR2012E		2,558.00	205
20X14	CDPOR2014E		2,901.00	233
20X16	CDPOR2016E		3,114.00	250
20X18	CDPOR2018E		3,092.00	248
24X12	CDPOR2412E		3,065.00	337
24X14	CDPOR2414E		3,501.00	339
24X16	CDPOR2416E		4,730.00	340
24X18	CDPOR2418E		4,856.00	390
24X20	CDPOR2420E		5,241.00	421

**REDUCERS : PO X FE**

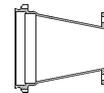

Size (in.)	Item No.	Crt. Qty.	List Price (\$)	Wt. (lb.)
6 X 4	CDPOFR0604E	16	410.00	32
8 X 4	CDPOFR0804E	16	596.00	46
8 X 6	CDPOFR0806E	36	602.00	47
10X 4	CDPOFR1004E		671.00	55
10X 6	CDPOFR1006E	12	718.00	59
10X 8	CDPOFR1008E	18	1,136.00	60
12X 4	CDPOFR1204E		946.00	78
12X 6	CDPOFR1206E	8	914.00	73
12X 8	CDPOFR1208E	8	898.00	74
12X10	CDPOFR1210E		1,152.00	95
14X 6	CDPOFR1406E		1,466.00	121
14X 8	CDPOFR1408E		1,550.00	128
14X10	CDPOFR1410E		1,539.00	127
14X12	CDPOFR1412E		1,742.00	144
16X 6	CDPOFR1606E		1,608.00	136
16X 8	CDPOFR1608E		1,706.00	144
16X10	CDPOFR1610E		1,911.00	160
16X12	CDPOFR1612E	4	2,076.00	170
16X14	CDPOFR1614E		2,368.00	196
18X 8	CDPOFR1808E		1,961.00	157
18X10	CDPOFR1810E		2,186.00	175
18X12	CDPOFR1812E		2,681.00	215
18X14	CDPOFR1814E		2,916.00	234
18X16	CDPOFR1816E		3,065.00	246
20X10	CDPOFR2010E		2,916.00	234
20X14	CDPOFR2014E		3,106.00	249
20X16	CDPOFR2016E		3,388.00	272
24X12	CDPOFR2412E		3,266.00	262
24X14	CDPOFR2414E		3,923.00	315
24X16	CDPOFR2416E		4,088.00	328

**PUSH-ON GASKET**



Size (in.)	Item No.	Crt. Qty.	List Price (\$)	Wt. (lb.)
4	6655.04E	180	POA	0.4
6	6655.06E	100	POA	0.6
8	6655.08E	80	POA	0.7
10	6655.10E	60	POA	0.9
12	6655.12E	60	POA	1.0
14	6655.14E	60	POA	1.3
16	6655.16E	50	POA	1.5

**TRANSITION PUSH-ON GASKET**



Size (in.)	Item No.	Crt. Qty.	List Price (\$)	Wt. (lb.)
4	6656.04E	180	POA	0.4
6	6656.06E	100	POA	0.6
8	6656.08E	80	POA	0.7
10	6656.10E	60	POA	0.9
12	6656.12E	60	POA	1.0

CALL FOR BARE/BARE FITTINGS

## PO CAPS SOLID

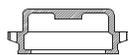

Size (in.)	Item No.	Crt. Qty.	List Price (\$)	Wt. (lb.)
4	CDPOC04E	120	148.00	13
6	CDPOC06E	72	222.00	20
8	CDPOC08E	54	344.00	32
10	CDPOC10E	36	453.00	40
12	CDPOC12E	24	635.00	63
14	CDPOC14E		POA	70
16	CDPOC16E	12	POA	110
18	CDPOC18E		POA	120
20	CDPOC20E		POA	150
24	CDPOC24E	4	POA	216

## PO CAPS TAPPED

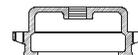

Size (in.)	Item No.	Crt. Qty.	List Price (\$)	Wt. (lb.)
4	CDPOCT04E	120	210.00	13
6	CDPOCT06E	72	286.00	20
8	CDPOCT08E	54	407.00	32
10	CDPOCT10E	36	516.00	40
12	CDPOCT12E	24	698.00	63
14	CDPOCT14E		POA	70
16	CDPOCT16E	12	POA	110
18	CDPOCT18E		POA	120
20	CDPOCT20E		POA	150
24	CDPOCT24E		POA	216

## PO PLUGS SOLID



Size (in.)	Item No.	Crt. Qty.	List Price (\$)	Wt. (lb.)
4	CDPOP04E	200	113.00	12
6	CDPOP06E	96	191.00	18
8	CDPOP08E	72	262.00	29
10	CDPOP10E	36	392.00	35
12	CDPOP12E	30	453.00	46
14	CDPOP14E		1,215.00	74
16	CDPOP16E	20	3,719.00	60
18	CDPOP18E		4,022.00	120
20	CDPOP20E		4,372.00	145
24	CDPOP24E	4	4,667.00	204

## PO PLUGS TAPPED

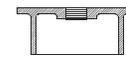

Size (in.)	Item No.	Crt. Qty.	List Price (\$)	Wt. (lb.)
4	CDPOPT04E	100	152.00	12
6	CDPOPT06E	72	255.00	18
8	CDPOPT08E	54	324.00	29
10	CDPOPT10E	36	455.00	35
12	CDPOPT12E	24	513.00	46
14	CDPOPT14E		1,518.00	74
16	CDPOPT16E	8	4,353.00	60
18	CDPOPT18E		4,587.00	120
20	CDPOPT20E		4,858.00	145
24	CDPOPT24E	4	5,711.00	204

CALL FOR BARE/BARE FITTINGS

NOTES



# SIP Industries

Quality Manufacturers Since 1960



## PRODUCT LINE

### AWWA DI Fittings & Accessories

- C153 Compact MJ Fittings and Acc. 2" - 64"
- C110 Full Body MJ Fittings 2" - 64"
- C153 Trim Tyton® Push-On Fittings 4" - 24"
- C110 Flange Fittings 2" - 64"
- MJ x MJ Adapter for Connecting MJ Bells 3" - 24"
- Stainless Steel & Blue T-Bolts
- Made in India, China & Mexico
- Bare, Cement, Zinc, FBE & Other Linings

### Joint Restraint System

- EZD Joint Restraint for DI Pipe 3" - 48"
- EZDTP Joint Restraint Tandem for DI Pipe 3" - 48"
- EZDPTP Joint Restraint for Push-On Joints DI Pipe 3" - 48"
- Ductile Iron Retainer Glands 3" - 30"
- FAR / FAH Flange Adapter for DI Pipe 3" - 48"
- EZFA Restrained Flange Adapter for DI and PVC Pipe 3" - 36"
- EZPVC Joint Restraint for PVC Pipe 3" - 36"
- ULTRA Joint Restraint for PVC Pipe 4" - 12"
- EZPVCPTP Joint Restraint for Push-On Joints PVC Pipe 14" - 36"
- PTPVC Pipe to Pipe Restraint 4" - 48"
- PTPDF Pipe to MJ Fittings Restraint 4" - 48"
- PTPFC Pipe to PVC Fittings Restraint 4" - 12"
- Made in China & USA
- EZ Shield or Shop Coating

### Municipal Construction Castings

- Manhole Rings and Cover
- Frames and Grates
- Valve Boxes and Service Boxes
- Water Meter Covers and Boxes
- Cleanout and Monument Boxes
- Detectable Warning Plates
- Extension Rings
- Trench Grates and Tree Grates
- Made in India & USA

### Fabrication Products for DI Pipe

- High Hub Flanges Class 150 and 250. 3" - 64"
- Threaded Bell Flanges 3" - 48"
- Anchor Flanges 3" - 60"
- Filler Flanges 4" - 30"

### Other Products and Services

- All Thread Rod
- Pipe Lube and Hydraulic Cement
- Socket Clamps and Lugs
- Flange Packs
- OEM Castings



**SIP CORPORATE** 8876 Gulf Freeway, Suite 500, Houston, TX 77017

**SIP CENTRAL** 2900 Patio Drive, Houston, TX 77017

**SIP EAST** 600 Rayloc Drive, Atlanta, GA 30336

**SIP WEST** 8333 Almeria Avenue, Fontana, CA 92335

Phone: 877-921-6111 or 713-923-6111 | Fax: 713-923-6114 | [www.sipindustries.com](http://www.sipindustries.com) | [sales@sipindustries.com](mailto:sales@sipindustries.com)