



SIP INDUSTRIES  
SERAMPORE  
SINCE 1960

# SIP Industries



Quality Manufacturers Since 1960

## Utility Pipe Fittings Fusion Bonded Epoxy

# PRICE LIST

Effective : January 14, 2019

[www.sipindustries.com](http://www.sipindustries.com)

Toll Free 877-921-6111





										NOTES

## TABLE OF CONTENTS

GENERAL TERMS & CONDITIONS.....	Page : P002 - P004
FUSION BONDED EPOXY COMPACT MJ FITTINGS ANSI/AWWA C153/A21.53.....	Page : P005 - P018
FUSION BONDED EPOXY FULL BODY MJ FITTINGS ANSI/AWWA C110/A21.10.....	Page : P019 - P032
FUSION BONDED EPOXY COMPACT PUSH-ON FITTINGS ANSI/AWWA C153/A21.53.....	Page : P033 - P040
FUSION BONDED EPOXY FLANGE FITTINGS ANSI/AWWA C110/A21.10.....	Page : P041 - P054

- All dimensions are in inches unless noted otherwise.
- All weights are approximate in pounds unless noted otherwise.
- POA = Price on availability.
- R = Available multiple size reductions.

## SIP INDUSTRIES

### GENERAL TERMS AND CONDITIONS OF SALE

**1. Acceptance.** All sales by SIP Industries (Seller) are made pursuant to these Terms and Conditions. Submission of a purchase order to Seller, and/or acceptance of goods delivered by Seller, shall be deemed an acceptance of these Terms and Conditions by Purchaser. Please note that these Terms and Conditions may be modified from time to time; the applicable Terms and Conditions are those posted on SIP's website, [www.sipindustries.com](http://www.sipindustries.com), at the time that a purchase order is accepted or an agreement otherwise confirmed. Purchaser's alteration or addition to these Terms and Conditions, as same may be in effect from time to time, is expressly rejected unless accepted in writing by an authorized representative of Seller.

**2. Entire Agreement.** These Terms and Conditions, together with Seller's price list and Purchaser's purchase order, when accepted by Seller, shall be the entire agreement between Seller and Purchaser. Neither Seller nor Purchaser is relying on any representations, warranties or agreements except as expressly provided in these Terms and Conditions and in an accepted purchase order. To the extent of any conflict between the terms of a purchase order or any other documents submitted by Purchaser, on the one hand, and these Terms and Conditions, on the other, these Terms and Conditions shall govern.

**3. Prices.** Prices and descriptions of goods stated in Seller's price lists are subject to change without notice. Prices are subject to tariffs, raw material surcharges, labor disputes and shipping surcharges. To submit a purchase order, SIP Industries item numbers and part codes should be included. Seller's quotations are on globally sourced products unless otherwise noted. The ordering party is responsible to specify any required origin as required for end use. Quotations, if provided by Seller, expire sixty (60) days from the date provided unless otherwise agreed in writing.

**4. Terms.** Invoices are due and payable thirty (30) days from date of shipment, unless otherwise written on the invoice or confirmed in writing by Seller. A five percent (5%) late fee will be charged on all past-due accounts. If it becomes necessary to retain attorneys to collect an account, the Purchaser is liable for Seller's attorney's fees and other costs of collection.

**5. FOB point of shipment.** All prices are FOB point of shipment, unless otherwise agreed in writing. Seller's responsibility for goods therefore ceases and title passes to the Purchaser at the point of shipment; all claims for damages or losses in transit must be directed to the carrier with copy to Seller within ten (10) days of shipment.

**6. Delivery.** Seller shall have the right to select the freight carrier unless otherwise agreed. Seller has the right to substitute material with same function and design to accommodate unforeseen delays, shortages or restrictions.

**7. Cancellations, Changes and Returns.** All cancellations, changes and returns must be accepted in writing by an authorized representative of Seller, otherwise they will not be valid and binding on Seller. Seller will not be responsible for unauthorized returned product. It will be the responsibility of purchaser at their expense to have unauthorized product returned or disposed of. Seller shall not be obligated to accept any cancellation, change or return, but if it does so the following terms shall apply: (i) goods must be returned to Seller's facility, in the same condition in which they were accepted by Purchaser; (ii) a handling charge of thirty-five percent (35%) of the purchase price will be deducted from the credit given to Purchaser; and (iii) shipping charges, if not prepaid by Purchaser, will likewise be deducted from the credit given to Purchaser.

**8. Specially Manufactured Goods.** Unless otherwise agreed, specially-manufactured goods, including goods designed to the Purchaser's specifications, may not be cancelled or returned once work has begun to design or manufacture the goods unless an agreement is reached and confirmed in writing by Seller, including compensation to Seller for work thus far done with respect to the goods.

**9. Delays; Force Majeure.** Seller shall not be liable for any expenses, loss or damage resulting from any delay in delivery of goods or other failure of Seller's performance due to fire, floods, acts of god, strikes, labor disputes, labor shortages, riots, accidents, transportation delays or other causes beyond the reasonable control of Seller.

**10. Disclaimer regarding weights.** All stated weights are approximate and are given for inventory and shipping purposes only.

**11. Taxes.** Seller's prices do not include sales, excise or other taxes. Purchaser shall pay all such taxes. If Purchaser claims a tax exemption, Purchaser shall provide Seller with the necessary tax-exemption numbers and certificates. If Seller accepts an exemption but is later required by the taxing authority to pay taxes, Purchaser shall reimburse to Seller the amount of such taxes.

**12. Limited Warranty.** For a period of one calendar year from the date of shipment, Seller warrants that goods sold and delivered by Seller to Purchaser will conform to the number and type of goods described in the accepted purchase order and that such goods will be free from defects in material and workmanship.

THIS LIMITED WARRANTY IS SELLER'S SOLE AND EXCLUSIVE WARRANTY. SELLER MAKES NO OTHER WARRANTY OF ANY KIND, EXPRESS OR IMPLIED. SELLER DOES NOT WARRANT THAT THE GOODS ARE FIT FOR ANY PARTICULAR PURPOSE. SELLER DOES NOT WARRANT THAT THE GOODS ARE MERCHANTABLE.

**13. Product Disclaimers.** All tooling required to manufacture products are the property of Seller even if tooling costs are incurred by Purchaser. Seller has the right to change product design, engineering, materials, tooling and processes that do not affect the intended use and application of the product. Seller will notify Purchaser if changes are substantial and may affect the application or appearance of the product. Furthermore, references to Buyer's specifications and similar requirements are only to describe the goods and do not give rise to any representation, warranty or other sales term.

Seller manufactures to industry standards and makes every effort to address applications of its products. Please see current technical advisory at Seller's web site, sipindustries.com, for up to date product support and recommendations. All product dimension, designs, technology, tooling, process, software, innovations, and drawings are considered intellectual property and are owned and confidential to Seller. Purchaser has no rights or privileges to SIP industries intellectual property including product applications without Seller's express written consent.

**14. Prompt notice required for Limited Warranty claims.** Buyer is responsible for promptly inspecting goods on delivery and notifying Seller, within sixty (60) days of delivery to Buyer, of any nonconformity or defect that would be discovered on a reasonable and customary inspection. Provided that such notice is given and that the warranty claim is made within one year, Seller will provide a replacement or price adjustment, in Seller's discretion, not to exceed the net sales price of the defective product. However, this warranty shall be of no force or effect absent such timely notice. Seller shall not in any event be responsible for labor, removal or installation charges incurred in connection with the replacement of defective goods.

**15. Conditions to Limited Warranty.** Purchaser shall notify Seller immediately upon discovery of a defect so that Seller may inspect the product in its installed condition. Seller shall not be responsible for defects or failures in goods of which it is not so notified; nor shall Seller be responsible for goods manufactured or sold by other parties or losses or impairments caused by such goods; nor shall Seller be responsible for defects or failure of goods due to improper installation, improper usage, normal or abnormal wear and tear, erosion or corrosion, improper storage, use or maintenance, vandalism, vehicular or other accidents, or storms or other forces beyond the control of the parties. Seller also shall not be responsible for goods that have been damaged by misuse, negligence or accident or that have been altered or repaired by any party other than Seller.

**16. Limitation on Liability.** In the event any remedy hereunder fails of its essential purpose and monetary damages may be imposed, Seller's liability, whether founded in contract or tort (including negligence), arising out of or resulting from (i) the Purchase Order and resulting contract or the performance or breach thereof, or (ii) the design, manufacture, delivery, sale, repair, replacement or use of the goods, shall not exceed the cost of the goods at issue in the claim. NOTWITHSTANDING ANYTHING CONTAINED HEREIN TO THE CONTRARY, SELLER SHALL NOT BE LIABLE TO PURCHASER OR ANY OTHER PERSON FOR CONSEQUENTIAL, INCIDENTAL, SPECIAL, EXEMPLARY, PUNITIVE OR OTHER INDIRECT DAMAGES, INCLUDING, WITHOUT LIMITATION, LOSS OF PROFITS, RECALL-RELATED EXPENSES, AND LOSS OF USE OF THE GOODS.

**17. Purchaser specifications.** If Seller has designed the goods using information provided by Purchaser, Seller shall not be responsible for design errors resulting from inaccurate or incomplete information supplied by Purchaser. If

Purchaser has provided specifications or a model or sample from which a good is designed and manufactured, Seller shall not be responsible for any defect, error or inadequacy provided that the good is designed or manufactured in compliance with Purchaser's specifications, model or sample.

**18. Solvency and Security Interest.** By submitting a Purchase Order, Buyer represents to Seller that Buyer is solvent and capable of timely fulfilling its payment and other obligations to Seller. Until the goods and any other indebtedness of Buyer have been paid in full, Buyer, its agents any successors: (i) will hold the goods subject to a security interest in favor of Seller allowing for the right or re-possession by Seller to the extent permitted by applicable law, (ii) will not alter, remove, destroy, or damage any identifying mark on the goods or their packaging, and (iii) will keep the goods separate from any other products.

**19. Governing law; venue.** All sales shall be governed by the law of the state of Texas. In the event that a lawsuit is filed between the parties on any claim arising out of or in connection with such sales, Seller and Purchaser agree that exclusive venue and jurisdiction shall be in the state or federal courts of Harris County, Texas.

**20. Attorney's fees and costs.** In the event of litigation between the parties with respect to the sale of goods, the prevailing party shall be entitled to recover its reasonable attorney's fees and costs, including expert witness fees.

# Utility Pipe Fittings Fusion Bonded Epoxy

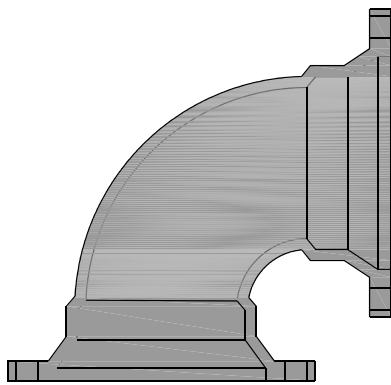

ANSI/AWWA C153/A21.53  
**COMPACT MJ FITTINGS**  
**FUSION BONDED EPOXY**

## PRICE LIST

Effective January 14, 2019.



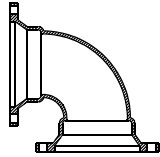

**BENDS : MJ X MJ**  
**90° (1/4)**

Size (in)	Item No.	Crt. Qty.	List Price (\$)	Wt. (lb.)
2	CDMJB9002E	36	104.00	14
3	CDMJB9003E	80	117.00	23
4	CDMJB9004E	60	127.00	27
6	CDMJB9006E	36	206.00	39
8	CDMJB9008E	18	303.00	57
10	CDMJB9010E	12	475.00	89
12	CDMJB9012E	8	637.00	108
14	CDMJB9014E	4	1,065.00	210
16	CDMJB9016E	2	1,424.00	264
18	CDMJB9018E		1,722.00	335
20	CDMJB9020E		2,336.00	400
24	CDMJB9024E		3,492.00	565
30	CDMJB9030E		5,613.00	960
36	CDMJB9036E		8,768.00	1499
42	CDMJB9042E		14,916.00	2205
48	CDMJB9048E		19,888.00	2990

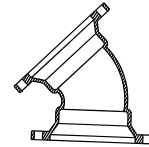
**BENDS : MJ X MJ**  
**45° (1/8)**

Size (in)	Item No.	Crt. Qty.	List Price (\$)	Wt. (lb.)
2	CDMJB4502E	36	82.00	13
3	CDMJB4503E	80	104.00	21
4	CDMJB4504E	100	104.00	23
6	CDMJB4506E	48	169.00	32
8	CDMJB4508E	27	245.00	46
10	CDMJB4510E	18	355.00	70
12	CDMJB4512E	12	527.00	86
14	CDMJB4514E	8	828.00	164
16	CDMJB4516E	8	1,033.00	202
18	CDMJB4518E	2	1,427.00	250
20	CDMJB4520E		1,553.00	305
24	CDMJB4524E		2,316.00	405
30	CDMJB4530E		4,713.00	783
36	CDMJB4536E		6,884.00	1142
42	CDMJB4542E		10,498.00	1610
48	CDMJB4548E		13,757.00	2090

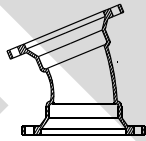
**BENDS : MJ X MJ**  
**22½° (1/16)**

Size (in)	Item No.	Crt. Qty.	List Price (\$)	Wt. (lb.)
2	CDMJB2202E	50	107.00	9
3	CDMJB2203E	50	66.00	16
4	CDMJB2204E	100	100.00	18
6	CDMJB2206E	48	154.00	32
8	CDMJB2208E	27	240.00	46
10	CDMJB2210E	18	352.00	64
12	CDMJB2212E	12	462.00	84
14	CDMJB2214E	8	839.00	148
16	CDMJB2216E	8	980.00	178
18	CDMJB2218E	2	1,216.00	255
20	CDMJB2220E	2	1,627.00	310
24	CDMJB2224E	2	2,155.00	412
30	CDMJB2230E		3,962.00	796
36	CDMJB2236E		5,790.00	1160
42	CDMJB2242E		8,648.00	1350
48	CDMJB2248E		11,285.00	1760

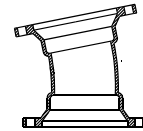
**BENDS : MJ X MJ**  
**11¼° (1/32)**

Size (in)	Item No.	Crt. Qty.	List Price (\$)	Wt. (lb.)
2	CDMJB1102E	30	129.00	8
3	CDMJB1103E	30	75.00	14
4	CDMJB1104E	50	94.00	16
6	CDMJB1106E	60	160.00	30
8	CDMJB1108E	27	217.00	42
10	CDMJB1110E	18	339.00	58
12	CDMJB1112E	16	428.00	74
14	CDMJB1114E	8	936.00	130
16	CDMJB1116E	4	1,015.00	158
18	CDMJB1118E	2	1,494.00	205
20	CDMJB1120E	2	1,513.00	245
24	CDMJB1124E	2	2,012.00	315
30	CDMJB1130E		3,947.00	800
36	CDMJB1136E		5,395.00	1165
42	CDMJB1142E		8,095.00	1180
48	CDMJB1148E		10,967.00	1475

CALL FOR BARE/BARE FITTINGS

\* AWWA C110



**BENDS : MJ X PE**  
**90° (1/4)**

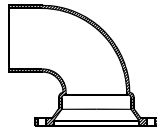

Size (in)	Item No.	Crt. Qty.	List Price (\$)	Wt. (lb.)
3	CDMJPB9003E	72	112.00	16
4	CDMJPB9004E	60	145.00	22
6	CDMJPB9006E	36	247.00	41
8	CDMJPB9008E	9	340.00	61
10	CDMJPB9010E	12	536.00	83
12	CDMJPB9012E	8	698.00	114
14	CDMJPB9014E	4	1,207.00	197
16	CDMJPB9016E	4	1,848.00	248
18	CDMJPB9018E		3,017.00	325
20	CDMJPB9020E		3,363.00	390
24	CDMJPB9024E		3,784.00	575
30	CDMJPB9030E		6,029.00	945
36	CDMJPB9036E		12,908.00	1362
42	CDMJPB9042E		13,820.00	2068
48	CDMJPB9048E		24,566.00	

**BENDS : MJ X PE**  
**45° (1/8)**

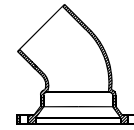

Size (in)	Item No.	Crt. Qty.	List Price (\$)	Wt. (lb.)
3	CDMJPB4503E	100	94.00	13
4	CDMJPB4504E	100	109.00	19
6	CDMJPB4506E	24	185.00	34
8	CDMJPB4508E	24	289.00	49
10	CDMJPB4510E	18	434.00	72
12	CDMJPB4512E	12	604.00	98
14	CDMJPB4514E	8	964.00	148
16	CDMJPB4516E	8	1,158.00	184
18	CDMJPB4518E	2	2,429.00	235
20	CDMJPB4520E		2,534.00	290
24	CDMJPB4524E		2,566.00	390
30	CDMJPB4530E		4,984.00	772
36	CDMJPB4536E		11,557.00	1056
42	CDMJPB4542E		12,318.00	1505
48	CDMJPB4548E		15,622.00	2055

**BENDS : MJ X PE**  
**22½° (1/16)**

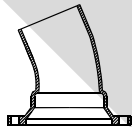

Size (in)	Item No.	Crt. Qty.	List Price (\$)	Wt. (lb.)
3	CDMJPB2203E	100	80.00	12
4	CDMJPB2204E	100	110.00	18
6	CDMJPB2206E	48	186.00	29
8	CDMJPB2208E		288.00	43
10	CDMJPB2210E	18	387.00	61
12	CDMJPB2212E	12	505.00	81
14	CDMJPB2214E	8	999.00	133
16	CDMJPB2216E	8	1,560.00	166
18	CDMJPB2218E		1,722.00	235
20	CDMJPB2220E		2,400.00	300
24	CDMJPB2224E		3,369.00	395
30	CDMJPB2230E		4,179.00	600
36	CDMJPB2236E		POA	
42	CDMJPB2242E		POA	
48	CDMJPB2248E		POA	

**BENDS : MJ X PE**  
**11¼° (1/32)**

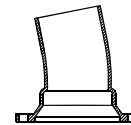

Size (in)	Item No.	Crt. Qty.	List Price (\$)	Wt. (lb.)
3	CDMJPB1103E	100	80.00	12
4	CDMJPB1104E	100	106.00	17
6	CDMJPB1106E	48	175.00	27
8	CDMJPB1108E		272.00	39
10	CDMJPB1110E	18	342.00	52
12	CDMJPB1112E	12	438.00	70
14	CDMJPB1114E	8	816.00	122
16	CDMJPB1116E	8	1,012.00	148
18	CDMJPB1118E		1,722.00	235
20	CDMJPB1120E		2,400.00	300
24	CDMJPB1124E		3,375.00	465
30	CDMJPB1130E		8,356.00	562
42	CDMJPB1142E		16,263.00	

CALL FOR BARE/BARE FITTINGS

\* AWWA C110

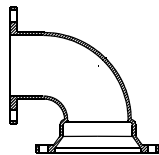
**BENDS : MJ X FE**  
**90° (1/4)**

Size (in)	Item No.	Crt. Qty.	List Price (\$)	Wt. (lb.)
3	CDMJFB9003E	72	123.00	20
4	CDMJFB9004E	48	154.00	26
6	CDMJFB9006E	27	265.00	47
8	CDMJFB9008E	18	442.00	68
10	CDMJFB9010E	12	690.00	102
12	CDMJFB9012E	8	983.00	134
14	CDMJFB9014E	4	1,683.00	223
16	CDMJFB9016E	4	2,048.00	303
24	CDMJFB9024E		5,327.00	625
30	CDMJFB9030E		9,306.00	1020

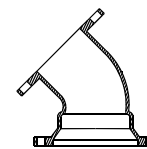
**BENDS : MJ X FE**  
**45° (1/8)**

Size (in)	Item No.	Crt. Qty.	List Price (\$)	Wt. (lb.)
3	CDMJFB4503E	32	148.00	17
4	CDMJFB4504E	100	152.00	24
6	CDMJFB4506E	48	223.00	39
8	CDMJFB4508E	27	425.00	57
10	CDMJFB4510E	18	645.00	83
12	CDMJFB4512E	12	927.00	111
14	CDMJFB4514E	8	1,365.00	208
16	CDMJFB4516E	8	1,904.00	300
24	CDMJFB4524E		3,960.00	617
30	CDMJFB4530E		15,410.00	1014

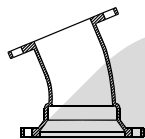
**BENDS : MJ X FE**  
**22½° (1/16)**

Size (in)	Item No.	Crt. Qty.	List Price (\$)	Wt. (lb.)
3	CDMJFB2203E	24	227.00	18
4	CDMJFB2204E	100	194.00	27
6	CDMJFB2206E	48	247.00	36
8	CDMJFB2208E	27	384.00	53
10	CDMJFB2210E	18	557.00	100
12	CDMJFB2212E	12	809.00	145
30	CDMJFB2230E		14,347.00	

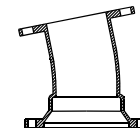
**BENDS : MJ X FE**  
**11¼° (1/32)**

Size (in)	Item No.	Crt. Qty.	List Price (\$)	Wt. (lb.)
4	CDMJFB1104E	100	170.00	20
6	CDMJFB1106E	48	240.00	30
8	CDMJFB1108E	27	318.00	50
10	CDMJFB1110E	18	522.00	74
12	CDMJFB1112E	12	669.00	85

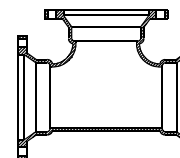
**TEES : MJ X MJ**

Size (in)	Item No.	Crt. Qty.	List Price (\$)	Wt. (lb.)
8 X 3	CDMJT0803E	9	350.00	52
8 X 4	CDMJT0804E	27	319.00	60
8 X 6	CDMJT0806E	18	372.00	72
8 X 6 X 6	CDMJT080606E	9	816.00	75
8 X 6 X 8	CDMJT080608E	9	827.00	85
8 X 8	CDMJT0808E	18	449.00	86
10X 3	CDMJT1003E	6	456.00	75
10X 4	CDMJT1004E	18	474.00	78
10X 6	CDMJT1006E	12	475.00	90

CALL FOR BARE/BARE FITTINGS

Size (in)	Item No.	Crt. Qty.	List Price (\$)	Wt. (lb.)
2 X 2	CDMJT0202E		129.00	22
3 X 2	CDMJT0302E		272.00	43
3 X 3	CDMJT0303E	50	155.00	28
4 X 2	CDMJT0402E	36	236.00	29
4 X 3	CDMJT0403E	16	182.00	35
4 X 4	CDMJT0404E	60	170.00	32
6 X 2	CDMJT0602E		POA	42
6 X 3	CDMJT0603E	12	226.00	42
6 X 4	CDMJT0604E	36	276.00	46
6 X 4 X 6	CDMJT060406E	12	590.00	60
6 X 6	CDMJT0606E	24	299.00	56
6 X 6 X 8	CDMJT060608E	25	528.00	75

\* AWWA C110

Contd.....

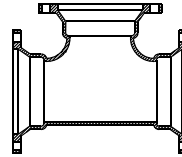

**TEES : MJ X MJ**  
Contd.....

Size (in)	Item No.	Crt. Qty.	List Price (\$)	Wt. (lb.)
10X 8	CDMJT1008E	12	556.00	105
10X10	CDMJT1010E	12	635.00	120
12X 3	CDMJT1203E		619.00	90
12X 4	CDMJT1204E	12	578.00	94
12X 6	CDMJT1206E	8	600.00	110
12X 8	CDMJT1208E	8	692.00	125
12X10	CDMJT1210E	8	857.00	140
12X12	CDMJT1212E	8	887.00	160
14X 6	CDMJT1406E	8	958.00	182
14X 8	CDMJT1408E	8	1,085.00	206
14X10	CDMJT1410E	8	1,397.00	228
14X12	CDMJT1412E	4	1,499.00	234
14X14	CDMJT1414E	4	1,473.00	280
16X 4	CDMJT1604E		2,050.00	
16X 6	CDMJT1606E	4	1,237.00	228
16X 8	CDMJT1608E	4	1,343.00	248
16X10	CDMJT1610E	2	1,712.00	264
16X12	CDMJT1612E	4	1,605.00	280
16X14	CDMJT1614E	4	2,110.00	316
16X16	CDMJT1616E	4	2,026.00	322
18X 4	CDMJT1804E		2,798.00	
18X 6	CDMJT1806E		1,725.00	287
18X 8	CDMJT1808E		1,867.00	295
18X10	CDMJT1810E		1,843.00	325
18X12	CDMJT1812E		2,216.00	340
18X14	CDMJT1814E		2,766.00	380
18X16	CDMJT1816E		2,888.00	425
18X18	CDMJT1818E		2,886.00	450
20X 6	CDMJT2006E		1,939.00	320
20X 8	CDMJT2008E		1,984.00	366
20X10	CDMJT2010E		2,612.00	370
20X12	CDMJT2012E		2,455.00	395
20X14	CDMJT2014E		2,960.00	475
20X16	CDMJT2016E		2,416.00	505
20X18	CDMJT2018E		3,805.00	505
20X20	CDMJT2020E		2,660.00	550
24X 6	CDMJT2406E		2,326.00	415
24X 8	CDMJT2408E		2,363.00	445
24X10	CDMJT2410E		3,112.00	470
24X12	CDMJT2412E		2,698.00	500

Size (in)	Item No.	Crt. Qty.	List Price (\$)	Wt. (lb.)
24X14	CDMJT2414E		3,658.00	550
24X16	CDMJT2416E		3,410.00	580
24X18	CDMJT2418E		3,946.00	625
24X20	CDMJT2420E		4,278.00	660
24X24	CDMJT2424E		3,948.00	720
30X 4	CDMJT3004E		5,609.00	
30X 6	CDMJT3006E		3,898.00	742
30X 8	CDMJT3008E		4,402.00	755
30X10	CDMJT3010E		7,187.00	
30X12	CDMJT3012E		4,942.00	817
30X16	CDMJT3016E		5,712.00	931
30X18	CDMJT3018E		8,165.00	1085
30X20	CDMJT3020E		6,039.00	995
30X24	CDMJT3024E		6,314.00	1389
30X30	CDMJT3030E		8,092.00	1318
36X 6	CDMJT3606E		7,663.00	1000
36X 8	CDMJT3608E		7,584.00	1050
36X10	CDMJT3610E		6,583.00	
36X12	CDMJT3612E		6,568.00	1150
36X16	CDMJT3616E		7,088.00	1167
36X18	CDMJT3618E		11,929.00	1505
36X20	CDMJT3620E		12,470.00	1520
36X24	CDMJT3624E		8,896.00	1498
36X30	CDMJT3630E		9,976.00	2381
36X36	CDMJT3636E		11,814.00	2065
42X 6	CDMJT4206E		14,166.00	1800
42X 8	CDMJT4208E		14,526.00	1980
42X12	CDMJT4212E		15,902.00	1950
42X16	CDMJT4216E		15,005.00	2040
42X18	CDMJT4218E		16,132.00	2195
42X20	CDMJT4220E		16,132.00	2235
42X24	CDMJT4224E		14,377.00	2270
42X30	CDMJT4230E		14,640.00	2608
42X36	CDMJT4236E		18,713.00	3000
42X42	CDMJT4242E		19,847.00	3175
48X 6	CDMJT4806E		22,688.00	2155
48X 8	CDMJT4808E		23,576.00	
48X12	CDMJT4812E		18,387.00	2620
48X16	CDMJT4816E		22,626.00	2650
48X18	CDMJT4818E		22,626.00	

\* AWWA C110

Contd.....

CALL FOR BARE/BARE FITTINGS

**TEES : MJ X MJ**

Contd.....

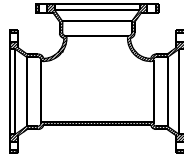

Size (in)	Item No.	Crt. Qty.	List Price (\$)	Wt. (lb.)
48X20	CDMJT4820E		22,626.00	
48X24	CDMJT4824E		17,678.00	2870
48X30	CDMJT4830E		27,577.00	3050
48X36	CDMJT4836E		24,939.00	3900
48X42	CDMJT4842E		30,555.00	4100
48X48	CDMJT4848E		26,626.00	4250

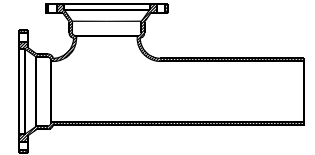
**TEES : MJ X PE X MJ**

Size (in)	Item No.	Crt. Qty.	List Price (\$)	Wt. (lb.)
6	CDMJPEMJT06E		334.00	57
8 X 6	CDMJPEMJT0806E		433.00	69
8	CDMJPEMJT08E	9	494.00	77
10	CDMJPEMJT10E		754.00	120
12	CDMJPEMJT12E		1,119.00	

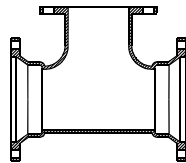
**TEES : MJ X FE**

Size (in)	Item No.	Crt. Qty.	List Price (\$)	Wt. (lb.)
3 X 3	CDMJFT0303E	40	196.00	30
4 X 2	CDMJFT0402E		POA	53
4 X 3	CDMJFT0403E	16	218.00	34
4 X 4	CDMJFT0404E	36	215.00	38
6 X 3	CDMJFT0603E	12	318.00	51
6 X 4	CDMJFT0604E	36	334.00	54
6 X 6	CDMJFT0606E	24	359.00	62
8 X 3	CDMJFT0803E		574.00	
8 X 4	CDMJFT0804E	27	397.00	79
8 X 6	CDMJFT0806E	18	414.00	80
8 X 8	CDMJFT0808E	18	527.00	90
10X 4	CDMJFT1004E	6	546.00	89
10X 6	CDMJFT1006E	8	684.00	110
10X 8	CDMJFT1008E	6	735.00	115
10X10	CDMJFT1010E	4	919.00	130
12X 4	CDMJFT1204E	8	733.00	117
12X 6	CDMJFT1206E	8	783.00	133
12X 8	CDMJFT1208E	8	884.00	135
12X10	CDMJFT1210E	4	985.00	150
12X12	CDMJFT1212E	4	1,219.00	170
14X 6	CDMJFT1406E	8	1,237.00	185
14X 8	CDMJFT1408E		POA	225
14X10	CDMJFT1410E	8	1,722.00	244
14X12	CDMJFT1412E	8	1,892.00	284
14X14	CDMJFT1414E	8	2,068.00	305
16X 6	CDMJFT1606E	2	1,397.00	210

Size (in)	Item No.	Crt. Qty.	List Price (\$)	Wt. (lb.)
16X 8	CDMJFT1608E	2	1,678.00	260
16X10	CDMJFT1610E	4	2,017.00	287
16X12	CDMJFT1612E	4	2,079.00	312
16X14	CDMJFT1614E	4	POA	348
16X16	CDMJFT1616E	4	2,872.00	374
18X 6	CDMJFT1806E	4	1,684.00	320
18X 8	CDMJFT1808E	4	2,207.00	352
18X12	CDMJFT1812E		POA	358
18X18	CDMJFT1818E		6,169.00	445
20X 6	CDMJFT2006E	4	2,346.00	362
20X 8	CDMJFT2008E		4,789.00	384
20X10	CDMJFT2010E		POA	
24X 6	CDMJFT2406E	2	2,678.00	408
24X 8	CDMJFT2408E		2,879.00	472
24X10	CDMJFT2410E		5,029.00	
24X12	CDMJFT2412E	2	3,764.00	580
24X16	CDMJFT2416E	2	4,736.00	745
24X18	CDMJFT2418E		POA	
24X20	CDMJFT2420E		POA	
24X24	CDMJFT2424E		5,554.00	923
30X 6	CDMJFT3006E		5,609.00	805
30X 8	CDMJFT3008E		POA	695
30X12	CDMJFT3012E		7,099.00	715
30X16	CDMJFT3016E		POA	1187
30X24	CDMJFT3024E		POA	
36X 6	CDMJFT3606E		9,560.00	1175
36X12	CDMJFT3612E		POA	
36X16	CDMJFT3616E		POA	1475
36X24	CDMJFT3624E		16,576.00	
36X36	CDMJFT3636E		POA	
42X24	CDMJFT4224E		POA	
42X30	CDMJFT4230E		20,063.00	

CALL FOR BARE/BARE FITTINGS

\* AWWA C110

**MJ X SWIVEL HYDRANT TEE  
(W/SWIVEL GLAND) ANCHOR TEE**

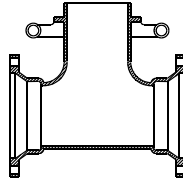

Size (in)	Item No.	Crt. Qty.	List Price (\$)	Wt. (lb.)
4 X 4	CDMJHT0404E		POA	
6 X 6	CDMJHT0606E	24	346.00	66
8 X 6	CDMJHT0806E	18	432.00	86
8 X 8	CDMJHT0808E	16	628.00	105
10X 6	CDMJHT1006E	12	533.00	110
10X 8	CDMJHT1008E	4	713.00	120
12X 6	CDMJHT1206E	8	617.00	128
12X 8	CDMJHT1208E	4	889.00	130
14X 6	CDMJHT1406E	8	1,403.00	211
16X 6	CDMJHT1606E	4	1,094.00	280
16X 8	CDMJHT1608E	4	2,343.00	298
18X 6	CDMJHT1806E		1,808.00	280
20X 6	CDMJHT2006E		1,797.00	360
24X 6	CDMJHT2406E		2,595.00	465
30X 6	CDMJHT3006E		7,718.00	
36X 6	CDMJHT3606E		8,662.00	

**CROSSES : MJ X MJ**

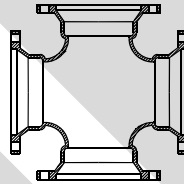

Size (in)	Item No.	Crt. Qty.	List Price (\$)	Wt. (lb.)
3 X 3	CDMJX0303E		202.00	40
4 X 3	CDMJX0403E		240.00	49
4 X 4	CDMJX0404E	12	343.00	42
6 X 4	CDMJX0604E	6	373.00	68
6 X 6	CDMJX0606E	16	433.00	80
8 X 4	CDMJX0804E	6	592.00	100
8 X 6	CDMJX0806E	12	434.00	105
8 X 8	CDMJX0808E	12	463.00	110
10X 4	CDMJX1004E	4	576.00	120
10X 6	CDMJX1006E	12	558.00	125
10X 8	CDMJX1008E	8	692.00	130
10X10	CDMJX1010E	8	730.00	145
12X 4	CDMJX1204E	8	713.00	123
12X 6	CDMJX1206E	8	702.00	140
12X 8	CDMJX1208E	8	808.00	155

Size (in)	Item No.	Crt. Qty.	List Price (\$)	Wt. (lb.)
12X10	CDMJX1210E	4	1,276.00	187
12X12	CDMJX1212E	8	1,276.00	215
14X 6	CDMJX1406E	8	1,273.00	210
14X 8	CDMJX1408E	8	1,438.00	230
14X10	CDMJX1410E		POA	255
14X12	CDMJX1412E		2,415.00	270
14X14	CDMJX1414E	4	2,206.00	336
16X 6	CDMJX1606E	4	1,529.00	250
16X 8	CDMJX1608E		1,768.00	264
16X10	CDMJX1610E		2,272.00	285
16X12	CDMJX1612E		2,429.00	310
16X16	CDMJX1616E		3,534.00	390
18X 6	CDMJX1806E		3,970.00	
18X10	CDMJX1810E		4,209.00	
18X12	CDMJX1812E		3,893.00	437
18X18	CDMJX1818E		4,123.00	657
20X 6	CDMJX2006E		3,473.00	
20X 8	CDMJX2008E		2,827.00	440
20X10	CDMJX2010E		3,446.00	
20X12	CDMJX2012E		2,719.00	558
20X16	CDMJX2016E		4,473.00	
20X18	CDMJX2018E		4,593.00	698
20X20	CDMJX2020E		6,154.00	798
24X 6	CDMJX2406E		3,166.00	481
24X 8	CDMJX2408E		3,289.00	500
24X10	CDMJX2410E		5,983.00	
24X12	CDMJX2412E		3,978.00	620
24X16	CDMJX2416E		4,736.00	720
24X18	CDMJX2418E		5,710.00	868
24X20	CDMJX2420E		6,672.00	1014
24X24	CDMJX2424E		5,908.00	1038
30X 6	CDMJX3006E		8,745.00	
30X 8	CDMJX3008E		8,518.00	
30X12	CDMJX3012E		7,882.00	1130
30X16	CDMJX3016E		12,537.00	
30X24	CDMJX3024E		12,719.00	1640
30X30	CDMJX3030E		12,816.00	1840
36X24	CDMJX3624E		16,808.00	1955
36X36	CDMJX3636E		18,670.00	2655
42X12	CDMJX4212E		17,233.00	
42X16	CDMJX4216E		18,059.00	
42X24	CDMJX4224E		19,370.00	
42X30	CDMJX4230E		30,760.00	
42X36	CDMJX4236E		34,629.00	3375

\* AWWA C110

Contd.....

CALL FOR BARE/BARE FITTINGS

**CROSSES : MJ X MJ**

Contd.....

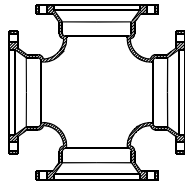

Size (in)	Item No.	Crt. Qty.	List Price (\$)	Wt. (lb.)
42X42	CDMJX4242E		39,009.00	
48X12	CDMJX4812E		23,609.00	
48X16	CDMJX4816E		24,813.00	
48X24	CDMJX4824E		35,535.00	
48X30	CDMJX4830E		37,626.00	4506
48X36	CDMJX4836E		37,795.00	4700
48X42	CDMJX4842E		37,907.00	
48X48	CDMJX4848E		36,445.00	5000

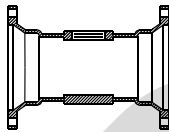
**TEES : MJ TAPPED 2"**

Size (in)	Item No.	Crt. Qty.	List Price (\$)	Wt. (lb.)
3	CDMJTT0303E	48	174.00	18
4	CDMJTT0404E	48	202.00	25
6	CDMJTT0606E	48	246.00	35
8	CDMJTT0808E	36	382.00	55
10	CDMJTT1010E	18	783.00	70
12	CDMJTT1212E	8	1,065.00	85
16	CDMJTT1616E		1,148.00	164

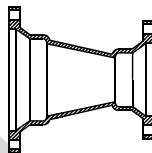
**REDUCERS : MJ X MJ**

Size (in)	Item No.	Crt. Qty.	List Price (\$)	Wt. (lb.)
3 X 2	CDMJR0302E		137.00	26
4 X 2	CDMJR0402E	36	137.00	35
4 X 3	CDMJR0403E	80	107.00	18
6 X 2	CDMJR0602E		184.00	45
6 X 3	CDMJR0603E	32	142.00	26
6 X 4	CDMJR0604E	64	120.00	24
8 X 3	CDMJR0803E		202.00	
8 X 4	CDMJR0804E	36	163.00	32
8 X 6	CDMJR0806E	36	175.00	36
10X 4	CDMJR1004E	9	256.00	46

\* AWWA C110

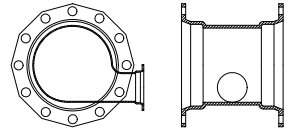
**TEES : MJ TANGENTIAL**

Size (in)	Item No.	Crt. Qty.	List Price (\$)	Wt. (lb.)
4	CDMJPESC04E	36	POA	50
6	CDMJPESC06E	18	POA	62
8	CDMJPESC08E	18	POA	90
10	CDMJPESC10E	8	POA	105
12	CDMJPESC12E	8	POA	128
16	CDMJPESC16E		POA	275

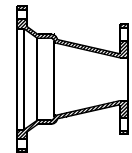
**REDUCERS : MJ X FE**

Size (in)	Item No.	Crt. Qty.	List Price (\$)	Wt. (lb.)
4 X 3	CDMJFR0403E		POA	17
6 X 4	CDMJFR0604E	32	POA	23
8 X 6	CDMJFR0806E	18	POA	34
12X 8	CDMJFR1208E		POA	58
18X 8	CDMJFR1808E		POA	190
18X12	CDMJFR1812E		POA	198
24X12	CDMJFR2412E		POA	318

Size (in)	Item No.	Crt. Qty.	List Price (\$)	Wt. (lb.)
10X 6	CDMJR1006E	27	224.00	47
10X 8	CDMJR1008E	24	246.00	50
12X 4	CDMJR1204E	18	326.00	58
12X 6	CDMJR1206E	18	296.00	60
12X 8	CDMJR1208E	18	304.00	60
12X10	CDMJR1210E	18	330.00	64
14X 6	CDMJR1406E	4	674.00	110
14X 8	CDMJR1408E	12	668.00	115
14X10	CDMJR1410E	12	527.00	120
14X12	CDMJR1412E	4	527.00	130
16X 6	CDMJR1606E	4	766.00	140
16X 8	CDMJR1608E	4	738.00	155
16X10	CDMJR1610E	4	712.00	160
16X12	CDMJR1612E	6	685.00	161
16X14	CDMJR1614E	4	869.00	165
18X 4	CDMJR1804E		1,516.00	
18X 8	CDMJR1808E		1,055.00	200
18X10	CDMJR1810E		1,034.00	195

Contd.....

**REDUCERS : MJ X MJ**

Contd.....

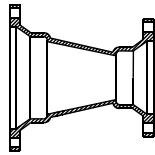

Size (in)	Item No.	Crt. Qty.	List Price (\$)	Wt. (lb.)
18X12	CDMJR1812E		1,006.00	180
18X14	CDMJR1814E		1,316.00	200
18X16	CDMJR1816E	2	1,066.00	195
20X 6	CDMJR2006E		2,238.00	232
20X 8	CDMJR2008E		1,335.00	227
20X10	CDMJR2010E		1,400.00	220
20X12	CDMJR2012E		1,118.00	205
20X14	CDMJR2014E		1,115.00	200
20X16	CDMJR2016E		1,034.00	215
20X18	CDMJR2018E	2	1,373.00	225
24X 8	CDMJR2408E		2,743.00	
24X10	CDMJR2410E		3,126.00	
24X12	CDMJR2412E		1,714.00	305
24X14	CDMJR2414E		3,405.00	310
24X16	CDMJR2416E		1,779.00	320
24X18	CDMJR2418E		1,695.00	305
24X20	CDMJR2420E		2,028.00	320
30X12	CDMJR3012E		5,844.00	705
30X16	CDMJR3016E		3,798.00	633
30X18	CDMJR3018E		3,939.00	658
30X20	CDMJR3020E		3,729.00	628
30X24	CDMJR3024E		2,848.00	478
36X12	CDMJR3612E		7,645.00	1037
36X16	CDMJR3616E		5,025.00	1078
36X18	CDMJR3618E		9,260.00	1329
36X20	CDMJR3620E		5,775.00	975
36X24	CDMJR3624E		4,586.00	770
36X30	CDMJR3630E		4,988.00	650
42X16	CDMJR4216E		POA	
42X18	CDMJR4218E		POA	
42X20	CDMJR4220E		7,459.00	
42X24	CDMJR4224E		8,497.00	1356
42X30	CDMJR4230E		6,687.00	1083
42X36	CDMJR4236E		6,992.00	1114
48X16	CDMJR4816E		POA	
48X18	CDMJR4818E		POA	
48X20	CDMJR4820E		9,394.00	
48X24	CDMJR4824E		9,628.00	1700
48X30	CDMJR4830E		11,603.00	1779
48X36	CDMJR4836E		10,222.00	1641
48X42	CDMJR4842E		10,865.00	1462

**REDUCERS : PE X PE**

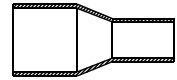

Size (in)	Item No.	Crt. Qty.	List Price (\$)	Wt. (lb.)
4 X 3	CDMJRP0403E	48	90.00	16
6 X 3	CDMJRP0603E	48	144.00	22
6 X 4	CDMJRP0604E	25	142.00	30
8 X 4	CDMJRP0804E	36	207.00	34
8 X 6	CDMJRP0806E	16	218.00	40
10X 4	CDMJRP1004E		407.00	
10X 6	CDMJRP1006E	9	287.00	46
10X 8	CDMJRP1008E	9	295.00	49
12X 4	CDMJRP1204E		363.00	58
12X 6	CDMJRP1206E	9	363.00	59
12X 8	CDMJRP1208E	9	373.00	59
12X10	CDMJRP1210E	9	345.00	62
14X12	CDMJRP1412E		523.00	95
16X 6	CDMJRP1606E		615.00	128
16X 8	CDMJRP1608E		798.00	130
16X10	CDMJRP1610E		786.00	129
16X12	CDMJRP1612E		654.00	115
16X14	CDMJRP1614E		920.00	133
18X10	CDMJRP1810E		2,098.00	
18X12	CDMJRP1812E		683.00	
20X12	CDMJRP2012E		1,949.00	
20X16	CDMJRP2016E		1,984.00	
24X 8	CDMJRP2408E		1,782.00	
24X20	CDMJRP2420E		1,945.00	
30X16	CDMJRP3016E		8,098.00	690

**REDUCERS : MJ LARGE END (LEB)**

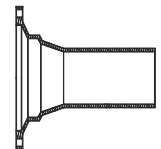

Size (in)	Item No.	Crt. Qty.	List Price (\$)	Wt. (lb.)
3 X 2	CDMJRL0302E		POA	20
4 X 2	CDMJRL0402E		POA	30
4 X 3	CDMJRL0403E	40	112.00	18
6 X 3	CDMJRL0603E	30	159.00	30
6 X 4	CDMJRL0604E	60	178.00	26
8 X 4	CDMJRL0804E	50	210.00	35
8 X 6	CDMJRL0806E	48	180.00	33
10X 4	CDMJRL1004E	4	268.00	44
10X 6	CDMJRL1006E	18	280.00	48
10X 8	CDMJRL1008E	16	305.00	50

CALL FOR BARE/BARE FITTINGS

\* AWWA C110

Contd.....



**REDUCERS :  
MJ LARGE END (LEB)**

Contd.....

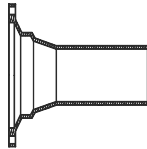

Size (in)	Item No.	Crt. Qty.	List Price (\$)	Wt. (lb.)
12X 4	CDMJRL1204E	4	460.00	60
12X 6	CDMJRL1206E	18	369.00	60
12X 8	CDMJRL1208E	18	382.00	62
12X10	CDMJRL1210E	18	394.00	64
14X 6	CDMJRL1406E		659.00	112
14X 8	CDMJRL1408E		659.00	108
14X10	CDMJRL1410E		524.00	92
14X12	CDMJRL1412E		607.00	96
16X 6	CDMJRL1606E	4	907.00	148
16X 8	CDMJRL1608E		968.00	140
16X10	CDMJRL1610E	4	826.00	123
16X12	CDMJRL1612E	4	663.00	119
16X14	CDMJRL1614E		875.00	135
18X 8	CDMJRL1808E		1,077.00	195
18X10	CDMJRL1810E		POA	185

Size (in)	Item No.	Crt. Qty.	List Price (\$)	Wt. (lb.)
18X12	CDMJRL1812E		1,154.00	175
18X14	CDMJRL1814E		1,316.00	200
18X16	CDMJRL1816E		1,265.00	192
20X10	CDMJRL2010E		1,384.00	210
20X12	CDMJRL2012E		1,820.00	210
20X14	CDMJRL2014E		1,129.00	205
20X16	CDMJRL2016E		1,066.00	238
20X18	CDMJRL2018E		POA	215
24X12	CDMJRL2412E		1,908.00	300
24X14	CDMJRL2414E		3,374.00	330
24X16	CDMJRL2416E		1,928.00	340
24X18	CDMJRL2418E		1,683.00	
24X20	CDMJRL2420E		3,576.00	
30X18	CDMJRL3018E		3,783.00	
30X24	CDMJRL3024E		4,808.00	
36X24	CDMJRL3624E		6,769.00	
36X30	CDMJRL3630E		4,967.00	
42X30	CDMJRL4230E		6,539.00	
42X36	CDMJRL4236E		POA	1114

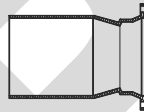
**REDUCERS :  
MJ SMALL END (SEB)**

Size (in)	Item No.	Crt. Qty.	List Price (\$)	Wt. (lb.)
3 X 2	CDMJRS0302E		POA	25
4 X 2	CDMJRS0402E		212.00	29
4 X 3	CDMJRS0403E	32	99.00	18
6 X 3	CDMJRS0603E	16	165.00	24
6 X 4	CDMJRS0604E	48	127.00	26
8 X 4	CDMJRS0804E	36	197.00	33
8 X 6	CDMJRS0806E	24	193.00	35
10X 4	CDMJRS1004E	4	268.00	44
10X 6	CDMJRS1006E	27	280.00	46
10X 8	CDMJRS1008E	12	297.00	49
12X 4	CDMJRS1204E	4	382.00	60
12X 6	CDMJRS1206E	27	398.00	58
12X 8	CDMJRS1208E	4	328.00	62
12X10	CDMJRS1210E	6	377.00	61
14X 6	CDMJRS1406E		POA	100
14X 8	CDMJRS1408E		POA	99
14X10	CDMJRS1410E	4	POA	97
14X12	CDMJRS1412E	4	POA	90
16X 6	CDMJRS1606E	4	832.00	125
16X 8	CDMJRS1608E	4	1,025.00	126

Size (in)	Item No.	Crt. Qty.	List Price (\$)	Wt. (lb.)
16X10	CDMJRS1610E	4	1,009.00	124
16X12	CDMJRS1612E	4	826.00	122
16X14	CDMJRS1614E	4	POA	133
18X 8	CDMJRS1808E		822.00	170
18X10	CDMJRS1810E		POA	165
18X12	CDMJRS1812E		988.00	155
18X14	CDMJRS1814E		POA	175
18X16	CDMJRS1816E		743.00	170
20X 8	CDMJRS2008E		1,717.00	
20X10	CDMJRS2010E		1,498.00	200
20X12	CDMJRS2012E		1,119.00	170
20X14	CDMJRS2014E		1,292.00	190
20X16	CDMJRS2016E		1,219.00	185
20X18	CDMJRS2018E		2,484.00	210
24X 8	CDMJRS2408E		POA	
24X12	CDMJRS2412E		1,812.00	275
24X14	CDMJRS2414E		POA	310
24X16	CDMJRS2416E		1,877.00	285
24X18	CDMJRS2418E		2,095.00	300
24X20	CDMJRS2420E		1,992.00	270
30X16	CDMJRS3016E		3,995.00	565
30X18	CDMJRS3018E		POA	648
30X20	CDMJRS3020E		4,113.00	560

CALL FOR BARE/BARE FITTINGS

\* AWWA C110

Contd.....

**REDUCERS : MJ SMALL  
END (SEB)** Contd.....

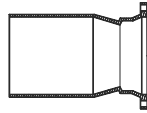

Size (in)	Item No.	Crt. Qty.	List Price (\$)	Wt. (lb.)
30X24	CDMJRS3024E		4,799.00	536
36X16	CDMJRS3616E		6,756.00	620
36X20	CDMJRS3620E		5,992.00	874
36X24	CDMJRS3624E		5,199.00	790
36X30	CDMJRS3630E		5,772.00	788
42X24	CDMJRS4224E		8,858.00	1204
42X30	CDMJRS4230E		6,849.00	931
42X36	CDMJRS4236E		7,526.00	1023
48X30	CDMJRS4830E		13,840.00	1625
48X42	CDMJRS4842E		14,628.00	

**HYDRANT ADAPTERS :  
SWIVEL X SOLID  
WITH SWIVEL GLAND  
(ANCHOR COUPLING)**

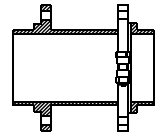

Size (in)	Item No.	Crt. Qty.	List Price (\$)	Wt. (lb.)
4 X 13	CDMJHA0413E	18	180.00	29
6 X 13	CDMJHA0613E	36	325.00	46
6 X 18	CDMJHA0618E	24	362.00	55
6 X 24	CDMJHA0624E	24	480.00	59
6 X 36	CDMJHA0636E	6	614.00	75
6 X 48	CDMJHA0648E		794.00	94
8 X 13	CDMJHA0813E	24	432.00	54
8 X 18	CDMJHA0818E		POA	67
8 X 24	CDMJHA0824E		POA	82
8 X 48	CDMJHA0848E		POA	143
10 X 13	CDMJHA1013E		688.00	
12 X 13	CDMJHA1213E	8	1,022.00	120

**ADAPTERS : MJ X FLANGE**

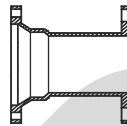

Size (in)	Item No.	Crt. Qty.	List Price (\$)	Wt. (lb.)
3	CDMJFA03E	150	100.00	14
4	CDMJFA04E	120	128.00	23
6	CDMJFA06E	45	166.00	30
8	CDMJFA08E	45	253.00	46
10	CDMJFA10E	30	433.00	62
12	CDMJFA12E	24	555.00	98
14	CDMJFA14E	20	836.00	143
16	CDMJFA16E	10	968.00	170
18	CDMJFA18E	2	1,406.00	220
20	CDMJFA20E	10	1,738.00	240
24	CDMJFA24E	2	2,094.00	322
30	CDMJFA30E		3,883.00	544
36	CDMJFA36E		5,563.00	798
42	CDMJFA42E		14,110.00	1214
48	CDMJFA48E		16,984.00	1600

**HYDRANT ADAPTERS :  
SWIVEL X SWIVEL  
WITH TWO-SWIVEL GLAND**

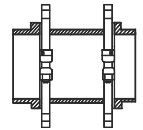

Size (in)	Item No.	Crt. Qty.	List Price (\$)	Wt. (lb.)
6 X 12	CDMJHHA0612E		POA	30
6 X 13	CDMJHHA0613E		290.00	
6 X 18	CDMJHHA0618E		POA	49
6 X 24	CDMJHHA0624E		398.00	52
8 X 13	CDMJHHA0813E		418.00	

**HYDRANT ELL :  
SWIVEL X SWIVEL  
WITH TWO-SWIVEL GLAND**

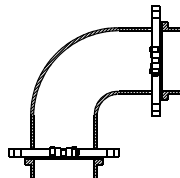

Size (in)	Item No.	Crt. Qty.	List Price (\$)	Wt. (lb.)
6	CDMJHB9006E	24	390.00	50

**SWIVEL GLAND**

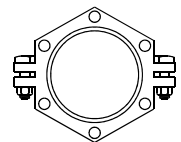

Size (in)	Item No.	Crt. Qty.	List Price (\$)	Wt. (lb.)
4	CDMJGS04E	100	POA	8
6	CDMJGS06E	100	POA	9
8	CDMJGS08E	100	POA	11
12	CDMJGS12E	50	POA	24

\* AWWA C110

CALL FOR BARE/BARE FITTINGS

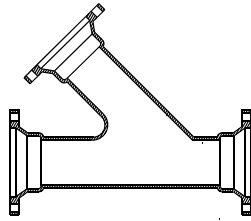
**MJ 45° LATERAL  
(WYES)**

Size (in)	Item No.	Crt. Qty.	List Price (\$)	Wt. (lb.)
3 X 3	CDMJL0303E		209.00	36
4 X 2	CDMJL0402E		424.00	
4 X 3	CDMJL0403E		232.00	40
4 X 4	CDMJL0404E	30	268.00	42
6 X 4	CDMJL0604E	12	277.00	53
6 X 6	CDMJL0606E	16	407.00	85
8 X 4	CDMJL0804E	6	559.00	75
8 X 6	CDMJL0806E	6	469.00	92
8 X 8	CDMJL0808E	6	588.00	105
10X 4	CDMJL1004E	4	908.00	147
10X 6	CDMJL1006E	4	957.00	156
10X 8	CDMJL1008E	4	1,040.00	172
10X10	CDMJL1010E	4	1,269.00	212
12X 4	CDMJL1204E	2	1,293.00	185
12X 6	CDMJL1206E	2	1,345.00	187
12X 8	CDMJL1208E	2	1,445.00	190
12X10	CDMJL1210E	2	1,696.00	245
12X12	CDMJL1212E	2	1,564.00	275
14X 6	CDMJL1406E	2	2,280.00	
14X 8	CDMJL1408E	2	4,396.00	
14X10	CDMJL1410E	2	2,424.00	
14X14	CDMJL1414E	2	2,766.00	474
16X 6	CDMJL1606E	2	1,823.00	300
16X 8	CDMJL1608E	2	2,136.00	349
16X10	CDMJL1610E		3,772.00	
16X12	CDMJL1612E		2,742.00	453
16X16	CDMJL1616E	2	3,333.00	575
18X 4	CDMJL1804E		4,405.00	
18X 6	CDMJL1806E		4,635.00	408
18X 8	CDMJL1808E		5,273.00	
18X10	CDMJL1810E		5,336.00	485
18X12	CDMJL1812E		6,125.00	510
18X18	CDMJL1818E		3,635.00	808
20X 8	CDMJL2008E		5,655.00	
20X20	CDMJL2020E		6,864.00	1525
24X10	CDMJL2410E		POA	1800
24X12	CDMJL2412E		POA	900
24X16	CDMJL2416E		5,922.00	1815
24X18	CDMJL2418E		6,380.00	1047
24X24	CDMJL2424E		8,233.00	1269

Size (in)	Item No.	Crt. Qty.	List Price (\$)	Wt. (lb.)
30X20	CDMJL3020E		POA	2575
30X24	CDMJL3024E		19,179.00	1575
30X30	CDMJL3030E		29,569.00	1269
36X 8	CDMJL3608E		POA	1430
36X20	CDMJL3620E		POA	2032
36X30	CDMJL3630E		24,270.00	5080
36X36	CDMJL3636E		27,923.00	2280
42X24	CDMJL4224E		POA	3400
42X42	CDMJL4242E		53,815.00	4438
48X18	CDMJL4818E		POA	3502
48X20	CDMJL4820E		POA	3695
48X24	CDMJL4824E		POA	4313
48X30	CDMJL4830E		POA	4522
48X48	CDMJL4848E		POA	5907

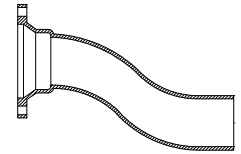
**MJ X PE OFFSET**

Size (in)	Item No.	Crt. Qty.	List Price (\$)	Wt. (lb.)
3 X 6	CDMJOP0306E		184.00	32
3 X 12	CDMJOP0312E		245.00	42
3 X 18	CDMJOP0318E		299.00	54
3 X 24	CDMJOP0324E		332.00	58
4 X 6	CDMJOP0406E	12	275.00	45
4 X 12	CDMJOP0412E	12	338.00	56
4 X 18	CDMJOP0418E	16	407.00	62
4 X 24	CDMJOP0424E	6	448.00	70
6 X 6	CDMJOP0606E	12	325.00	55
6 X 12	CDMJOP0612E	8	423.00	68
6 X 18	CDMJOP0618E	8	597.00	97
6 X 24	CDMJOP0624E	4	728.00	116
8 X 6	CDMJOP0806E	4	486.00	84
8 X 12	CDMJOP0812E	4	683.00	110
8 X 18	CDMJOP0818E	4	770.00	124
8 X 24	CDMJOP0824E	3	807.00	147
10 X 6	CDMJOP1006E	6	807.00	127
10 X 12	CDMJOP1012E	4	1,066.00	130
10 X 18	CDMJOP1018E	4	1,172.00	160
10 X 24	CDMJOP1024E	4	1,413.00	169
12 X 6	CDMJOP1206E	4	1,214.00	115
12 X 12	CDMJOP1212E	4	1,229.00	198
12 X 18	CDMJOP1218E	4	1,674.00	270
12 X 24	CDMJOP1224E	2	2,070.00	335
12 X 30	CDMJOP1230E		1,273.00	225

CALL FOR BARE/BARE FITTINGS

\* AWWA C110

**MJ OFFSET**

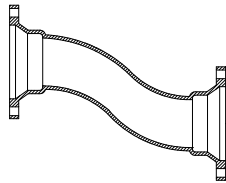

Size (in)	Item No.	Crt. Qty.	List Price (\$)	Wt. (lb.)
3 X 6	CDMJO0306E		142.00	30
3 X 12	CDMJO0312E		207.00	40
3 X 18	CDMJO0318E		242.00	49
3 X 24	CDMJO0324E		287.00	55
4 X 6	CDMJO0406E	12	194.00	25
4 X 12	CDMJO0412E	12	252.00	55
4 X 18	CDMJO0418E	8	338.00	65
4 X 24	CDMJO0424E	16	390.00	75
6 X 6	CDMJO0606E	12	332.00	29
6 X 12	CDMJO0612E	16	432.00	69
6 X 18	CDMJO0618E	8	527.00	87
6 X 24	CDMJO0624E	8	666.00	107
8 X 6	CDMJO0806E	4	476.00	80
8 X 12	CDMJO0812E	4	615.00	104
8 X 18	CDMJO0818E	4	766.00	135
8 X 24	CDMJO0824E	3	1,096.00	141
10 X 6	CDMJO1006E	4	679.00	110
10 X 12	CDMJO1012E	4	895.00	135
10 X 18	CDMJO1018E	4	1,066.00	165
10 X 24	CDMJO1024E	4	1,896.00	175
12 X 6	CDMJO1206E	4	960.00	118
12 X 12	CDMJO1212E	4	1,066.00	203
12 X 18	CDMJO1218E	4	1,288.00	230
12 X 24	CDMJO1224E	2	1,822.00	277
12 X 30	CDMJO1230E		1,730.00	285
16 X 12	CDMJO1612E		5,024.00	305
16 X 18	CDMJO1618E		5,943.00	362
20 X 12	CDMJO2012E		6,857.00	437
20 X 18	CDMJO2018E		9,465.00	581

**MJ PE CUTTING SLEEVES**

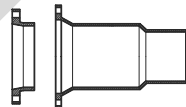

Size (in)	Item No.	Crt. Qty.	List Price (\$)	Wt. (lb.)
4	CDMJPESC04E	36	POA	50
6	CDMJPESC06E	18	POA	62
8	CDMJPESC08E	18	POA	90
10	CDMJPESC10E	8	POA	105
12	CDMJPESC12E	8	POA	128
16	CDMJPESC16E		POA	275

**MJ LONG SLEEVES**

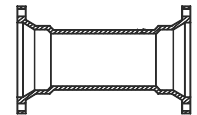

Size (in)	Item No.	Crt. Qty.	List Price (\$)	Wt. (lb.)
2	CDMJLS02E	50	123.00	7
3	CDMJLS03E	126	102.00	18
4	CDMJLS04E	75	110.00	20
6	CDMJLS06E	36	194.00	36
8	CDMJLS08E	27	306.00	46
10	CDMJLS10E	18	362.00	62
12	CDMJLS12E	12	472.00	76
14	CDMJLS14E	8	735.00	140
16	CDMJLS16E	8	929.00	172
18	CDMJLS18E	5	1,170.00	225
20	CDMJLS20E	5	1,415.00	255
24	CDMJLS24E	5	1,862.00	335
30	CDMJLS30E		3,835.00	694
36	CDMJLS36E		4,764.00	1016
42	CDMJLS42E		7,097.00	1390
48	CDMJLS48E		9,763.00	1740

**MJ SHORT SLEEVES**

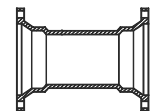

Size (in)	Item No.	Crt. Qty.	List Price (\$)	Wt. (lb.)
2	CDMJSS02E		POA	12
3	CDMJSS03E	50	80.00	13
4	CDMJSS04E	125	78.00	17
6	CDMJSS06E	60	139.00	28
8	CDMJSS08E	45	182.00	38
10	CDMJSS10E	30	317.00	49
12	CDMJSS12E	20	357.00	56
14	CDMJSS14E	16	667.00	111
16	CDMJSS16E	16	828.00	130
18	CDMJSS18E	2	1,034.00	160
20	CDMJSS20E	8	1,265.00	195
24	CDMJSS24E	2	1,672.00	255
30	CDMJSS30E		3,397.00	500
36	CDMJSS36E		4,609.00	725
42	CDMJSS42E		6,489.00	877
48	CDMJSS48E		8,112.00	1406

CALL FOR BARE/BARE FITTINGS

\* AWWA C110

**MJ CAPS : SOLID**

Size (in)	Item No.	Crt. Qty.	List Price (\$)	Wt. (lb.)
2	CDMJC02E		80.00	6
3	CDMJC03E	300	46.00	8
4	CDMJC04E	240	49.00	10
6	CDMJC06E	144	88.00	17
8	CDMJC08E	108	135.00	22
10	CDMJC10E	72	176.00	32
12	CDMJC12E	52	254.00	42
14	CDMJC14E	36	387.00	70
16	CDMJC16E	20	518.00	98
18	CDMJC18E	20	633.00	120
20	CDMJC20E	20	806.00	130
24	CDMJC24E	10	1,107.00	170
30	CDMJC30E	2	2,463.00	385
36	CDMJC36E	2	4,378.00	614
42	CDMJC42E		6,570.00	893
48	CDMJC48E		7,917.00	1067

**MJ CAPS : 2" TAPPED**

Size (in)	Item No.	Crt. Qty.	List Price (\$)	Wt. (lb.)
2	CDMJCT02E		108.00	10
3	CDMJCT03E	300	87.00	8
4	CDMJCT04E	240	89.00	10
6	CDMJCT06E	144	128.00	17
8	CDMJCT08E	108	174.00	22
10	CDMJCT10E	72	215.00	32
12	CDMJCT12E	52	294.00	42
14	CDMJCT14E	36	456.00	70
16	CDMJCT16E	20	579.00	98
18	CDMJCT18E	20	718.00	120
20	CDMJCT20E	20	898.00	130
24	CDMJCT24E	10	1,170.00	170
30	CDMJCT30E	2	2,579.00	385
36	CDMJCT36E	2	4,494.00	614
42	CDMJCT42E		6,726.00	893
48	CDMJCT48E		8,073.00	1076

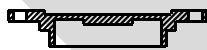
**MJ PLUGS : SOLID**

Size (in)	Item No.	Crt. Qty.	List Price (\$)	Wt. (lb.)
2	CDMJP02E		73.00	6
3	CDMJP03E	100	65.00	8
4	CDMJP04E	100	59.00	10
6	CDMJP06E	144	109.00	22
8	CDMJP08E	66	160.00	32
10	CDMJP10E	52	275.00	40
12	CDMJP12E	40	280.00	55
14	CDMJP14E	16	580.00	70
16	CDMJP16E	10	743.00	105
18	CDMJP18E	4	922.00	125
20	CDMJP20E	4	1,193.00	139
24	CDMJP24E	4	1,655.00	180
30	CDMJP30E	2	3,229.00	433
36	CDMJP36E	2	4,988.00	674
42	CDMJP42E		6,839.00	1067
48	CDMJP48E		9,118.00	1313

**MJ PLUGS : 2" TAPPED**

Size (in)	Item No.	Crt. Qty.	List Price (\$)	Wt. (lb.)
2	CDMJPT02E		104.00	5
3	CDMJPT03E	300	103.00	8
4	CDMJPT04E	240	98.00	10
6	CDMJPT06E	144	148.00	22
8	CDMJPT08E	108	199.00	32
10	CDMJPT10E	66	314.00	40
12	CDMJPT12E	24	319.00	55
14	CDMJPT14E	32	607.00	70
16	CDMJPT16E	20	782.00	105
18	CDMJPT18E	20	946.00	125
20	CDMJPT20E	20	1,188.00	139
24	CDMJPT24E	10	1,603.00	180
30	CDMJPT30E	2	3,225.00	433
36	CDMJPT36E	2	4,939.00	674
42	CDMJPT42E		6,977.00	1067
48	CDMJPT48E		9,274.00	1313

CALL FOR BARE/BARE FITTINGS

\* AWWA C110

# Utility Pipe Fittings Fusion Bonded Epoxy

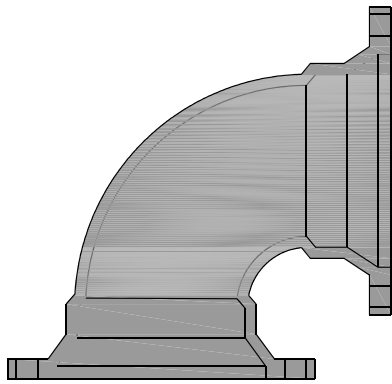

ANSI/AWWA C110/A21.10  
**FULL BODY MJ FITTINGS**  
**FUSION BONDED EPOXY**

**PRICE LIST**  
Effective January 14, 2019.



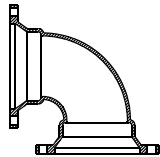

**BENDS : MJ X MJ**  
**90° (1/4)**

Size (in)	Item No.	Crt. Qty.	List Price (\$)	Wt. (lb.)
2	XDMJB9002E	36	234.00	14
3	XDMJB9003E	36	215.00	35
4	XDMJB9004E	24	284.00	55
6	XDMJB9006E	12	436.00	85
8	XDMJB9008E	12	698.00	125
10	XDMJB9010E	4	1,179.00	190
12	XDMJB9012E	4	1,346.00	255
14	XDMJB9014E	0	2,445.00	380
16	XDMJB9016E	0	2,934.00	430
18	XDMJB9018E	0	4,173.00	545
20	XDMJB9020E	0	4,715.00	680
24	XDMJB9024E	0	6,180.00	1025
30	XDMJB9030E	0	10,972.00	1690
36	XDMJB9036E	0	14,962.00	2475
42	XDMJB9042E	0	25,080.00	3410
48	XDMJB9048E	0	33,795.00	4595

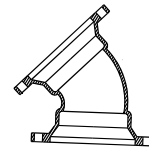
**BENDS :MJ X MJ**  
**45° (1/8)**

Size (in)	Item No.	Crt. Qty.	List Price (\$)	Wt. (lb.)
2	XDMJB4502E	36	163.00	13
3	XDMJB4503E	0	184.00	30
4	XDMJB4504E	36	257.00	50
6	XDMJB4506E	12	389.00	75
8	XDMJB4508E	12	574.00	110
10	XDMJB4510E	4	877.00	155
12	XDMJB4512E	4	1,133.00	215
14	XDMJB4514E	0	1,778.00	270
16	XDMJB4516E	0	2,263.00	340
18	XDMJB4518E	0	2,886.00	420
20	XDMJB4520E	0	3,098.00	530
24	XDMJB4524E	0	4,349.00	755
30	XDMJB4530E	0	8,636.00	1380
36	XDMJB4536E	0	12,955.00	2095
42	XDMJB4542E	0	21,735.00	2955
48	XDMJB4548E	0	30,008.00	4080

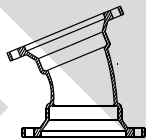
**BENDS : MJ X MJ**  
**22½° (1/16)**

Size (in)	Item No.	Crt. Qty.	List Price (\$)	Wt. (lb.)
2	XDMJB2202E	0	169.00	13
3	XDMJB2203E	0	184.00	30
4	XDMJB2204E	12	299.00	50
6	XDMJB2206E	12	403.00	75
8	XDMJB2208E	12	780.00	110
10	XDMJB2210E	4	967.00	160
12	XDMJB2212E	4	1,186.00	220
14	XDMJB2214E	0	1,812.00	275
16	XDMJB2216E	0	2,240.00	345
18	XDMJB2218E	0	2,829.00	430
20	XDMJB2220E	0	3,707.00	535
24	XDMJB2224E	0	4,280.00	765
30	XDMJB2230E	0	8,323.00	1400
36	XDMJB2236E	0	12,625.00	2135
42	XDMJB2242E	0	22,213.00	3020
48	XDMJB2248E	0	30,670.00	4170

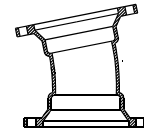
**BENDS : MJ X MJ**  
**11¼° (1/32)**

Size (in)	Item No.	Crt. Qty.	List Price (\$)	Wt. (lb.)
2	XDMJB1102E	0	224.00	13
3	XDMJB1103E	0	180.00	30
4	XDMJB1104E	12	299.00	50
6	XDMJB1106E	12	449.00	75
8	XDMJB1108E	12	588.00	110
10	XDMJB1110E	0	967.00	160
12	XDMJB1112E	6	1,345.00	220
14	XDMJB1114E	0	1,812.00	275
16	XDMJB1116E	0	2,272.00	345
18	XDMJB1118E	0	2,927.00	430
20	XDMJB1120E	0	3,684.00	540
24	XDMJB1124E	0	5,009.00	770
30	XDMJB1130E	0	9,799.00	1410
36	XDMJB1136E	0	15,050.00	2145
42	XDMJB1142E	0	22,324.00	3035
48	XDMJB1148E	0	30,818.00	4190

CALL FOR BARE/BARE FITTINGS



**BENDS : MJ X PE**  
**90° (1/4)**

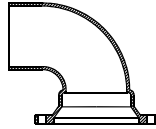

Size (in)	Item No.	Crt. Qty.	List Price (\$)	Wt. (lb.)
3	XDMJBP9003E	0	218.00	35
4	XDMJBP9004E	8	312.00	50
6	XDMJBP9006E	12	583.00	80
8	XDMJBP9008E	12	915.00	120
10	XDMJBP9010E	8	1,179.00	170
12	XDMJBP9012E	4	1,580.00	255
14	XDMJBP9014E	0	3,308.00	330
16	XDMJBP9016E	0	2,698.00	410
18	XDMJBP9018E	0	3,422.00	600
20	XDMJBP9020E	0	4,275.00	775
24	XDMJBP9024E	0	6,479.00	985
30	XDMJBP9030E	0	11,043.00	1920
36	XDMJBP9036E	0	16,092.00	2310
42	XDMJBP9042E	0	26,276.00	3215
48	XDMJBP9048E	0	45,096.00	4345

**BENDS : MJ X PE**  
**45° (1/8)**

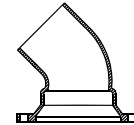

Size (in)	Item No.	Crt. Qty.	List Price (\$)	Wt. (lb.)
3	XDMJBP4503E	24	189.00	32
4	XDMJBP4504E	50	288.00	45
6	XDMJBP4506E	12	486.00	70
8	XDMJBP4508E	24	735.00	105
10	XDMJBP4510E	12	1,043.00	155
12	XDMJBP4512E	4	1,333.00	215
14	XDMJBP4514E	4	1,675.00	258
16	XDMJBP4516E	4	1,956.00	320
18	XDMJBP4518E	0	2,599.00	455
20	XDMJBP4520E	0	3,289.00	664
24	XDMJBP4524E	2	4,649.00	715
30	XDMJBP4530E	0	8,884.00	1510
36	XDMJBP4536E	0	13,445.00	1930
42	XDMJBP4542E	0	24,312.00	2745
48	XDMJBP4548E	0	34,858.00	3820

**BENDS : MJ X PE**  
**22½° (1/16)**

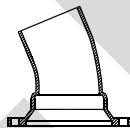

Size (in)	Item No.	Crt. Qty.	List Price (\$)	Wt. (lb.)
3	XDMJBP2203E	24	577.00	32
4	XDMJBP2204E	24	283.00	50
6	XDMJBP2206E	0	436.00	70
8	XDMJBP2208E	0	654.00	105
10	XDMJBP2210E	0	992.00	160
12	XDMJBP2212E	0	1,363.00	220
14	XDMJBP2214E	4	POA	335
16	XDMJBP2216E	0	2,142.00	365
18	XDMJBP2218E	0	2,667.00	455
20	XDMJBP2220E	0	3,325.00	575
24	XDMJBP2224E	0	4,770.00	930
30	XDMJBP2230E	0	9,753.00	1540
36	XDMJBP2236E	0	13,724.00	1970
42	XDMJBP2242E	0	26,125.00	2815

**BENDS : MJ X PE**  
**11¼° (1/32)**

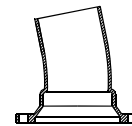

Size (in)	Item No.	Crt. Qty.	List Price (\$)	Wt. (lb.)
3	XDMJBP1103E	24	377.00	32
4	XDMJBP1104E	24	570.00	50
6	XDMJBP1106E	24	742.00	70
8	XDMJBP1108E	16	654.00	105
12	XDMJBP1112E	0	963.00	220
14	XDMJBP1114E	0	3,962.00	260
16	XDMJBP1116E	2	4,870.00	365
18	XDMJBP1118E	0	POA	455
20	XDMJBP1120E	0	5,765.00	575
24	XDMJBP1124E	0	4,802.00	845
30	XDMJBP1130E	0	9,093.00	1305
36	XDMJBP1136E	0	13,792.00	2185
48	XDMJBP1148E	0	37,108.00	3945

CALL FOR BARE/BARE FITTINGS

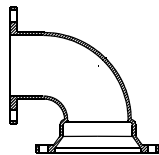
**BENDS : MJ X FE**  
**90° (1/4)**

Size (in)	Item No.	Crt. Qty.	List Price (\$)	Wt. (lb.)
4	XDMJFB9004E	0	314.00	53
6	XDMJFB9006E	0	438.00	75
8	XDMJFB9008E	2	679.00	115
10	XDMJFB9010E	0	983.00	177
12	XDMJFB9012E	0	1,617.00	246
16	XDMJFB9016E	0	2,816.00	465
18	XDMJFB9018E	0	3,494.00	577
20	XDMJFB9020E	0	4,199.00	745
24	XDMJFB9024E	0	7,900.00	1150

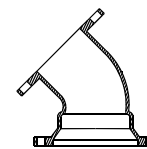
**BENDS : MJ X FE**  
**45° (1/8)**

Size (in)	Item No.	Crt. Qty.	List Price (\$)	Wt. (lb.)
4	XDMJFB4504E	0	263.00	45
6	XDMJFB4506E	0	409.00	69
8	XDMJFB4508E	0	619.00	105
10	XDMJFB4510E	0	958.00	155
12	XDMJFB4512E	0	1,245.00	215
16	XDMJFB4516E	0	2,180.00	360
18	XDMJFB4518E	0	2,829.00	422
20	XDMJFB4520E	0	3,974.00	543
24	XDMJFB4524E	0	6,032.00	903

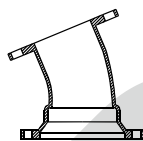
**BENDS : MJ X FE**  
**22½° (1/16)**

Size (in)	Item No.	Crt. Qty.	List Price (\$)	Wt. (lb.)
4	XDMJFB2204E	0	528.00	45
6	XDMJFB2206E	0	360.00	69
8	XDMJFB2208E	0	619.00	105
10	XDMJFB2210E	0	899.00	155
12	XDMJFB2212E	0	1,389.00	215
16	XDMJFB2216E	0	1,958.00	373
18	XDMJFB2218E	0	2,089.00	422
20	XDMJFB2220E	0	5,876.00	575
24	XDMJFB2224E	0	5,555.00	800

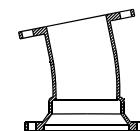
**BENDS : MJ X FE**  
**11¼° (1/32)**

Size (in)	Item No.	Crt. Qty.	List Price (\$)	Wt. (lb.)
4	XDMJFB1104E	0	492.00	45
6	XDMJFB1106E	0	413.00	69
8	XDMJFB1108E	0	610.00	105
10	XDMJFB1110E	0	1,382.00	155
12	XDMJFB1112E	0	1,245.00	215
16	XDMJFB1116E	0	2,214.00	360
18	XDMJFB1118E	0	2,609.00	422
20	XDMJFB1120E	0	5,876.00	575
24	XDMJFB1124E	0	5,555.00	800

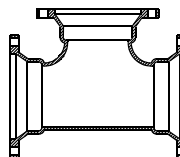
**TEES : MJ X MJ**

Size (in)	Item No.	Crt. Qty.	List Price (\$)	Wt. (lb.)
2 X 2	XDMJT0202E	36	180.00	22
3 X 2	XDMJT0302E		283.00	43
3 X 3	XDMJT0303E		383.00	55
4 X 2	XDMJT0402E	24	766.00	65
4 X 3	XDMJT0403E		467.00	75
4 X 4	XDMJT0404E	12	477.00	80

Size (in)	Item No.	Crt. Qty.	List Price (\$)	Wt. (lb.)
4 X 4 X 6	XDMJT040406E		POA	115
6 X 2	XDMJT0602E	12	635.00	100
6 X 3	XDMJT0603E	24	657.00	110
6 X 4	XDMJT0604E	12	688.00	115
6 X 6	XDMJT0606E	12	669.00	125
6 X 6 X 8	XDMJT060608E		POA	185

Contd.....

CALL FOR BARE/BARE FITTINGS

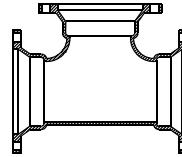

**TEES : MJ X MJ**  
Contd.....

Size (in)	Item No.	Crt. Qty.	List Price (\$)	Wt. (lb.)
8 X 3	XDMJT0803E		1,258.00	155
8 X 4	XDMJT0804E	9	987.00	165
8 X 6	XDMJT0806E	9	929.00	175
8 X 8	XDMJT0808E	9	1,004.00	185
10 X 3	XDMJT1003E		POA	216
10 X 4	XDMJT1004E	12	1,457.00	235
10 X 6	XDMJT1006E	4	1,510.00	250
10 X 8	XDMJT1008E	4	1,570.00	260
10 X 10	XDMJT1010E	4	1,873.00	310
12 X 3	XDMJT1203E		POA	290
12 X 4	XDMJT1204E	8	1,926.00	315
12 X 6	XDMJT1206E	4	1,794.00	325
12 X 8	XDMJT1208E	4	2,079.00	340
12 X 10	XDMJT1210E	4	2,384.00	390
12 X 12	XDMJT1212E	4	2,496.00	410
14 X 4	XDMJT1404E		3,466.00	383
14 X 6	XDMJT1406E	4	2,863.00	435
14 X 8	XDMJT1408E		2,960.00	450
14 X 10	XDMJT1410E		3,062.00	465
14 X 12	XDMJT1412E		3,258.00	495
14 X 14	XDMJT1414E		3,422.00	520
16 X 4	XDMJT1604E		4,369.00	600
16 X 6	XDMJT1606E		3,553.00	540
16 X 8	XDMJT1608E		3,618.00	550
16 X 10	XDMJT1610E		3,750.00	570
16 X 12	XDMJT1612E		3,882.00	590
16 X 14	XDMJT1614E		4,079.00	620
16 X 16	XDMJT1616E		4,524.00	650
18 X 4	XDMJT1804E		POA	528
18 X 6	XDMJT1806E		3,882.00	590
18 X 8	XDMJT1808E		3,982.00	605
18 X 10	XDMJT1810E		4,079.00	620
18 X 12	XDMJT1812E		4,209.00	640
18 X 14	XDMJT1814E		4,969.00	755
18 X 16	XDMJT1816E		5,165.00	785
18 X 18	XDMJT1818E		5,395.00	820
20 X 6	XDMJT2006E	2	5,240.00	725
20 X 8	XDMJT2008E	2	6,065.00	735
20 X 10	XDMJT2010E		4,969.00	755
20 X 12	XDMJT2012E	2	5,033.00	775

Size (in)	Item No.	Crt. Qty.	List Price (\$)	Wt. (lb.)
20 X 14	XDMJT2014E		5,230.00	795
20 X 16	XDMJT2016E		6,145.00	945
20 X 18	XDMJT2018E		6,479.00	985
20 X 20	XDMJT2020E		5,668.00	1020
24 X 4	XDMJT2404E		7,453.00	985
24 X 6	XDMJT2406E		6,479.00	985
24 X 8	XDMJT2408E		6,577.00	1000
24 X 10	XDMJT2410E		7,832.00	1020
24 X 12	XDMJT2412E		6,775.00	1030
24 X 14	XDMJT2414E		6,942.00	1055
24 X 16	XDMJT2416E		7,150.00	1075
24 X 18	XDMJT2418E		9,206.00	1400
24 X 20	XDMJT2420E		11,177.00	1450
24 X 24	XDMJT2424E		11,345.00	1535
30 X 6	XDMJT3006E		12,050.00	1730
30 X 8	XDMJT3008E		12,158.00	1745
30 X 10	XDMJT3010E		12,260.00	1760
30 X 12	XDMJT3012E		12,399.00	1780
30 X 14	XDMJT3014E		17,802.00	1800
30 X 16	XDMJT3016E		18,008.00	1820
30 X 18	XDMJT3018E		12,854.00	1845
30 X 20	XDMJT3020E		13,063.00	1875
30 X 24	XDMJT3024E		16,716.00	2400
30 X 30	XDMJT3030E		18,076.00	2595
36 X 6	XDMJT3606E		17,414.00	2439
36 X 8	XDMJT3608E		17,553.00	2520
36 X 10	XDMJT3610E		18,182.00	2535
36 X 12	XDMJT3612E		17,764.00	2550
36 X 14	XDMJT3614E		17,903.00	2570
36 X 16	XDMJT3616E		15,224.00	2585
36 X 18	XDMJT3618E		18,182.00	2610
36 X 20	XDMJT3620E		18,355.00	2635
36 X 24	XDMJT3624E		18,738.00	2690
36 X 30	XDMJT3630E		24,695.00	3545
36 X 36	XDMJT3636E		21,077.00	3745
42 X 6	XDMJT4206E		43,455.00	3440
42 X 12	XDMJT4212E		26,147.00	3555
42 X 14	XDMJT4214E		26,295.00	3575
42 X 16	XDMJT4216E		26,442.00	3595
42 X 18	XDMJT4218E		45,824.00	3615

Contd.....

CALL FOR BARE/BARE FITTINGS

**TEES : MJ X MJ**

Contd.....

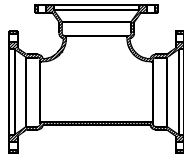

Size (in)	Item No.	Crt. Qty.	List Price (\$)	Wt. (lb.)
42 X 20	XDMJT4220E		45,852.00	3640
42 X 24	XDMJT4224E		27,142.00	3690
42 X 30	XDMJT4230E		34,199.00	4650
42 X 36	XDMJT4236E		44,680.00	6075
42 X 42	XDMJT4242E		46,483.00	6320
48 X 12	XDMJT4812E		50,845.00	4870
48 X 14	XDMJT4814E		50,756.00	4885
48 X 16	XDMJT4816E		52,666.00	4905
48 X 18	XDMJT4818E		54,334.00	4925
48 X 20	XDMJT4820E		49,527.00	4950
48 X 24	XDMJT4824E		36,738.00	4995
48 X 30	XDMJT4830E		37,804.00	5140
48 X 36	XDMJT4836E		46,188.00	6280
48 X 42	XDMJT4842E		59,793.00	8130
48 X 36 X 48	XDMJT483648E		POA	6397
48 X 48	XDMJT4848E		61,926.00	8420

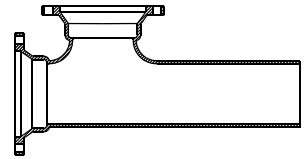
**TEES : MJ X PE X MJ**

Size (in)	Item No.	Crt. Qty.	List Price (\$)	Wt. (lb.)
4 X 4	XDMJPT0404E		POA	75
6 X 6	XDMJPT0606E		POA	120
8 X 4	XDMJPT0804E	6	1,298.00	160
8 X 6	XDMJPT0806E		POA	170
8 X 8	XDMJPT0808E		1,116.00	180
10 X 10	XDMJPT1010E		POA	250
12 X 4	XDMJPT1204E		POA	315
12 X 6	XDMJPT1206E		2,698.00	325
12 X 8	XDMJPT1208E		2,499.00	340
12 X 10	XDMJPT1210E		POA	390
12 X 12	XDMJPT1212E		3,076.00	410
14 X 14	XDMJPT1414E		3,808.00	500
16 X 8	XDMJPT1608E	2	3,718.00	530
16 X 16	XDMJPT1616E		4,746.00	625
24 X 6	XDMJPT2406E	2	8,774.00	945
24 X 8	XDMJPT2408E		8,977.00	960
24 X 12	XDMJPT2412E		9,150.00	990
24 X 16	XDMJPT2416E		9,512.00	1035
24 X 24	XDMJPT2424E		13,905.00	1490
36 X 12	XDMJPT3612E		24,510.00	2375
36 X 24	XDMJPT3624E		28,154.00	2515
36 X 36	XDMJPT3636E		39,755.00	3565

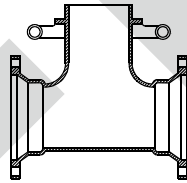
**MJ X SWIVEL  
HYDRANT TEE  
(W/SWIVEL GLAND)**

Size (in)	Item No.	Crt. Qty.	List Price (\$)	Wt. (lb.)
6 X 6	XDMJTH0606E	9	816.00	145
8 X 6	XDMJTH0806E	9	1,027.00	165
8 X 8	XDMJTH0808E		1,704.00	210
10 X 6	XDMJTH1006E		1,703.00	270
12 X 6	XDMJTH1206E	4	2,163.00	365
12 X 8	XDMJTH1208E	4	3,743.00	350
16 X 6	XDMJTH1606E		3,654.00	619
16 X 8	XDMJTH1608E		POA	649
20 X 6	XDMJTH2006E	2	11,809.00	725
24 X 6	XDMJTH2406E		14,553.00	973
30 X 6	XDMJTH3006E		13,876.00	2070
36 X 6	XDMJTH3606E		17,553.00	2830

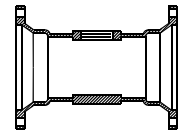
**TEES : MJ TAPPED 2"**

Size (in)	Item No.	Crt. Qty.	List Price (\$)	Wt. (lb.)
4 X 4	XDMJX0404TE	0	322.00	45
6 X 6	XDMJX0606TE	0	475.00	70
8 X 8	XDMJX0808TE	0	734.00	95
10 X 10	XDMJX1010TE	0	846.00	130
12 X 12	XDMJX1212TE	0	1,065.00	165
16 X 16	XDMJX16160TE	0	1,832.00	274
18 X 18	XDMJX1818TE	0	2,944.00	305
20 X 20	XDMJX2020TE	0	3,345.00	352
24 X 24	XDMJX2424TE	0	4,153.00	496

CALL FOR BARE/BARE FITTINGS

**TEES : MJ X FE**

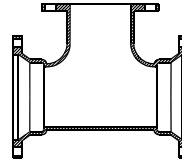

Size (in)	Item No.	Crt. Qty.	List Price (\$)	Wt. (lb.)
3 X 3	XDMJFT0303E		POA	45
4 X 2	XDMJFT0402E		534.00	53
4 X 4	XDMJFT0404E		555.00	74
6 X 3	XDMJFT0603E		1,040.00	115
6 X 4	XDMJFT0604E		804.00	109
6 X 6	XDMJFT0606E	2	868.00	120
8 X 4	XDMJFT0804E		1,102.00	159
8 X 6	XDMJFT0806E	2	984.00	170
8 X 8	XDMJFT0808E	2	1,193.00	194
10 X 4	XDMJFT1004E		1,424.00	229
10 X 6	XDMJFT1006E	12	1,394.00	245
10 X 8	XDMJFT1008E		1,544.00	250
12 X 4	XDMJFT1204E	2	1,987.00	323
12 X 6	XDMJFT1206E	2	1,922.00	320
12 X 8	XDMJFT1208E	2	2,765.00	342
12 X 10	XDMJFT1210E		POA	372
12 X 12	XDMJFT1212E		POA	401
14 X 6	XDMJFT1406E		4,298.00	457
14 X 8	XDMJFT1408E		6,336.00	473
16 X 4	XDMJFT1604E		3,784.00	575
16 X 6	XDMJFT1606E		3,982.00	605
16 X 8	XDMJFT1608E		4,048.00	615
16 X 12	XDMJFT1612E		4,285.00	651
16 X 16	XDMJFT1616E		4,802.00	730
18 X 6	XDMJFT1806E		4,375.00	665
18 X 8	XDMJFT1808E		4,442.00	675
18 X 12	XDMJFT1812E		4,639.00	735
18 X 18	XDMJFT1818E		6,019.00	915
20 X 6	XDMJFT2006E		5,679.00	820
20 X 8	XDMJFT2008E		5,494.00	835
20 X 12	XDMJFT2012E		6,220.00	700
20 X 20	XDMJFT2020E		7,663.00	1165
24 X 6	XDMJFT2406E		7,402.00	1125
24 X 8	XDMJFT2408E		7,496.00	1140
24 X 12	XDMJFT2412E		7,663.00	1165
24 X 18	XDMJFT2418E		12,203.00	1349
24 X 24	XDMJFT2424E		11,806.00	1795
30 X 6	XDMJFT3006E		11,913.00	1800

Size (in)	Item No.	Crt. Qty.	List Price (\$)	Wt. (lb.)
30 X 8	XDMJFT3008E		17,504.00	1725
30 X 30	XDMJFT3030E		POA	3080
36 X 6	XDMJFT3606E		17,335.00	2430
36 X 8	XDMJFT3608E		22,869.00	
36 X 12	XDMJFT3612E		17,764.00	2550
36 X 16	XDMJFT3616E		17,706.00	2450
36 X 24	XDMJFT3624E		24,374.00	2660
36 X 30	XDMJFT3630E		50,509.00	2964
36 X 36	XDMJFT3636E		51,126.00	3461
42 X 12	XDMJFT4212E		74,507.00	3547
42 X 16	XDMJFT4216E		75,088.00	3562
42 X 24	XDMJFT4224E		74,262.00	3527
48 X 24	XDMJFT4824E		POA	4965

**CROSSES : MJ X FE**

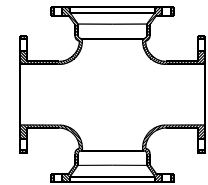

Size (in)	Item No.	Crt. Qty.	List Price (\$)	Wt. (lb.)
6 X 6	XDMJFX0606E	0	POA	140
8 X 6	XDMJFX0806E	0	POA	185
8 X 8	XDMJFX0808E	0	POA	240
10 X 10	XDMJFX1010E	0	POA	354
12 X 6	XDMJFX1206E	0	POA	340
12 X 8	XDMJFX1208E	0	POA	365
12 X 12	XDMJFX1212E	0	POA	487
16 X 8	XDMJFX1608E	0	POA	655
16 X 16	XDMJFX1616E	0	POA	875

**CALL FOR BARE/BARE FITTINGS**

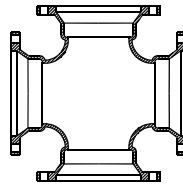

**CROSSES : MJ X MJ**

Size (in)	Item No.	Crt. Qty.	List Price (\$)	Wt. (lb.)
4 X 4	XDMJX0404E		654.00	105
6 X 4	XDMJX0604E		868.00	142
6 X 6	XDMJX0606E	8	954.00	160
8 X 4	XDMJX0804E		1,149.00	185
8 X 6	XDMJX0806E		1,273.00	205
8 X 8	XDMJX0808E	4	1,403.00	235
10 X 6	XDMJX1006E		1,767.00	285
10 X 8	XDMJX1008E		1,920.00	310
10 X 10	XDMJX1010E		2,353.00	380
12 X 4	XDMJX1204E		2,540.00	340
12 X 6	XDMJX1206E		2,229.00	360
12 X 8	XDMJX1208E	2	2,354.00	385
12 X 12	XDMJX1212E	2	3,025.00	495
14 X 8	XDMJX1408E		2,960.00	500
14 X 14	XDMJX1414E		4,178.00	635
16 X 6	XDMJX1606E		3,784.00	575
16 X 8	XDMJX1608E		3,982.00	605
16 X 12	XDMJX1612E		7,283.00	685
16 X 16	XDMJX1616E		5,196.00	790
18 X 8	XDMJX1808E		4,185.00	655
18 X 10	XDMJX1810E		4,507.00	685
18 X 12	XDMJX1812E		4,770.00	725
18 X 18	XDMJX1818E		6,546.00	995
20 X 8	XDMJX2008E		5,132.00	790
20 X 12	XDMJX2012E		5,658.00	860
20 X 16	XDMJX2016E		7,138.00	1085
20 X 20	XDMJX2020E		8,089.00	1230
24 X 6	XDMJX2406E		6,664.00	1025
24 X 8	XDMJX2408E		6,874.00	1045
24 X 12	XDMJX2412E		7,295.00	1110
24 X 16	XDMJX2416E		7,896.00	1200
24 X 20	XDMJX2420E		11,017.00	1675
24 X 24	XDMJX2424E		12,069.00	1835
30 X 6	XDMJX3006E		12,330.00	1770
30 X 12	XDMJX3012E		12,993.00	1865
30 X 16	XDMJX3016E		22,607.00	1968
30 X 24	XDMJX3024E		18,634.00	2675
30 X 30	XDMJX3030E		21,420.00	3075
36 X 12	XDMJX3612E		18,319.00	2645

Size (in)	Item No.	Crt. Qty.	List Price (\$)	Wt. (lb.)
36 X 16	XDMJX3616E		29,490.00	2718
36 X 20	XDMJX3620E		30,116.00	2815
36 X 24	XDMJX3624E		27,634.00	2910
36 X 30	XDMJX3630E		37,643.00	3978
36 X 36	XDMJX3636E		30,439.00	4370
42 X 24	XDMJX4224E		68,929.00	3924
42 X 30	XDMJX4230E		87,149.00	5039
42 X 36	XDMJX4236E		1,05,960.00	5428
42 X 42	XDMJX4242E		1,14,524.00	7145
48 X 24	XDMJX4824E		47,502.00	5225
48 X 30	XDMJX4830E		50,010.00	5510
48 X 36	XDMJX4836E		49,939.00	6795
48 X 42	XDMJX4842E		71,413.00	8827
48 X 48	XDMJX4848E		89,718.00	9400

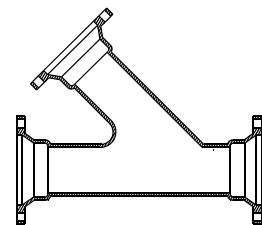
**MJ 45° LATERAL (WYES)**

Size (in)	Item No.	Crt. Qty.	List Price (\$)	Wt. (lb.)
3 X 3	XDMJL0303E		373.00	60
4 X 3	XDMJL0403E		626.00	
4 X 4	XDMJL0404E		559.00	90
6 X 4	XDMJL0604E	12	838.00	130
6 X 6	XDMJL0606E	4	1,045.00	145
8 X 4	XDMJL0804E		1,179.00	190
8 X 6	XDMJL0806E	4	1,273.00	205
8 X 8	XDMJL0808E	4	1,306.00	230
10 X 4	XDMJL1004E		2,746.00	274
10 X 6	XDMJL1006E		1,767.00	285
10 X 8	XDMJL1008E		1,892.00	310
10 X 10	XDMJL1010E		2,323.00	340
12 X 4	XDMJL1204E		2,577.00	382
12 X 6	XDMJL1206E		2,955.00	396
12 X 8	XDMJL1208E		2,632.00	425

Contd.....

CALL FOR BARE/BARE FITTINGS

**MJ 45° LATERAL (WYES)** Contd.....

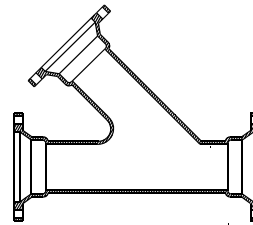

Size (in)	Item No.	Crt. Qty.	List Price (\$)	Wt. (lb.)
12 X 10	XDMJL1210E		3,789.00	512
12 X 12	XDMJL1212E		3,312.00	535
14 X 6	XDMJL1406E		3,719.00	615
14 X 8	XDMJL1408E		4,185.00	630
14 X 12	XDMJL1412E		5,852.00	652
14 X 14	XDMJL1414E		4,969.00	725
16 X 6	XDMJL1606E		5,066.00	770
16 X 8	XDMJL1608E		5,230.00	795
16 X 10	XDMJL1610E		5,460.00	835
16 X 12	XDMJL1612E		5,723.00	872
16 X 16	XDMJL1616E		5,854.00	1079
18 X 6	XDMJL1806E		4,802.00	752
18 X 8	XDMJL1808E		6,267.00	968
18 X 10	XDMJL1810E		7,038.00	975
18 X 12	XDMJL1812E		7,433.00	1015
18 X 16	XDMJL1816E		7,563.00	1135
18 X 18	XDMJL1818E		7,892.00	1200
20 X 06	XDMJL2006E		9,835.00	872
20 X 08	XDMJL2008E		10,460.00	689
20 X 10	XDMJL2010E		8,239.00	1220
20 X 12	XDMJL2012E		7,905.00	1260
20 X 14	XDMJL2014E		13,163.00	1368
20 X 16	XDMJL2016E		7,683.00	1375
20 X 20	XDMJL2020E		10,032.00	1525
24 X 6	XDMJL2406E		14,923.00	1874
24 X 8	XDMJL2408E		16,740.00	1882
24 X 12	XDMJL2412E		19,582.00	1388
24 X 16	XDMJL2416E		21,227.00	1827
24 X 18	XDMJL2418E		22,586.00	2075
24 X 20	XDMJL2420E		19,090.00	2148
24 X 24	XDMJL2424E		14,764.00	2372
30 X 12	XDMJL3012E		30,819.00	3125
30 X 16	XDMJL3016E		26,582.00	3264
30 X 18	XDMJL3018E		27,032.00	2995
30 X 20	XDMJL3020E		24,459.00	3418
30 X 24	XDMJL3024E		25,729.00	3292
30 X 30	XDMJL3030E		25,565.00	3670
36 X 12	XDMJL3612E		43,156.00	4695
36 X 16	XDMJL3616E		39,263.00	5050

Size (in)	Item No.	Crt. Qty.	List Price (\$)	Wt. (lb.)
36 X 18	XDMJL3618E		41,630.00	5025
36 X 20	XDMJL3620E		36,627.00	5090
36 X 24	XDMJL3624E		36,696.00	5851
36 X 30	XDMJL3630E		40,397.00	5815
36 X 36	XDMJL3636E		48,583.00	6900
42 X 24	XDMJL4224E		50,085.00	6810
42 X 30	XDMJL4230E		53,027.00	7280
42 X 36	XDMJL4236E		61,449.00	8355
42 X 42	XDMJL4242E		77,722.00	9915
48 X 20	XDMJL4820E		72,475.00	6554
48 X 24	XDMJL4824E		POA	
48 X 30	XDMJL4830E		76,038.00	6574
48 X 48	XDMJL4848E		82,982.00	11892

**MJ X PE OFFSET**

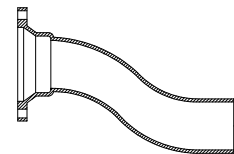

Size (in)	Item No.	Crt. Qty.	List Price (\$)	Wt. (lb.)
4 X 6	XDMJOP0406E		704.00	70
4 X 12	XDMJOP0412E		718.00	80
4 X 24	XDMJOP0424E		967.00	125
6 X 6	XDMJOP0606E		868.00	105
6 X 12	XDMJOP0612E		807.00	130
6 X 18	XDMJOP0618E		947.00	160
6 X 24	XDMJOP0624E		937.00	160
8 X 6	XDMJOP0806E		1,575.00	155
8 X 12	XDMJOP0812E		1,284.00	195
8 X 18	XDMJOP0818E		2,378.00	240
8 X 24	XDMJOP0824E		1,844.00	285
10 X 12	XDMJOP1012E		POA	280
10 X 18	XDMJOP1018E		POA	340
12 X 06	XDMJOP1206E		2,657.00	328
12 X 12	XDMJOP1212E		4,457.00	420
12 X 18	XDMJOP1218E	2	POA	520
12 X 24	XDMJOP1224E		POA	630
16 X 18	XDMJOP1618E		POA	690

CALL FOR BARE/BARE FITTINGS

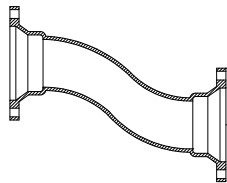

**MJ OFFSET**

Size (in)	Item No.	Crt. Qty.	List Price (\$)	Wt. (lb.)
4 X 6	XDMJO0406E	0	POA	75
4 X 12	XDMJO0412E	0	532.00	85
4 X 18	XDMJO0418E	0	654.00	105
4 X 24	XDMJO0424E	0	777.00	126
6 X 6	XDMJO0606E	0	683.00	114
6 X 12	XDMJO0612E	0	838.00	135
6 X 18	XDMJO0618E	0	1,025.00	188
6 X 24	XDMJO0624E	0	960.00	182
8 X 6	XDMJO0806E	0	992.00	177
8 X 12	XDMJO0812E	0	1,238.00	231
8 X 18	XDMJO0818E	0	1,513.00	287
8 X 24	XDMJO0824E	0	1,584.00	280
10 X 12	XDMJO1012E	0	2,072.00	347
10 X 18	XDMJO1018E	0	2,105.00	340
10 X 24	XDMJO1024E	0	2,599.00	420
12 X 6	XDMJO1206E	0	4,115.00	345
12 X 12	XDMJO1212E	0	2,599.00	420
12 X 18	XDMJO1218E	0	3,219.00	520
12 X 24	XDMJO1224E	0	3,962.00	649
16 X 12	XDMJO1612E	0	4,258.00	715
16 X 18	XDMJO1618E	0	4,570.00	850
20 X 12	XDMJO2012E	0	4,770.00	1025
20 X 18	XDMJO2018E	0	7,826.00	1246
20 X 24	XDMJO2024E	0	16,760.00	1362

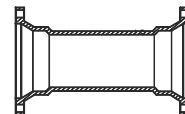
**MJ LONG SLEEVES**

Size (in)	Item No.	Crt. Qty.	List Price (\$)	Wt. (lb.)
2	XDMJSL02E	0	190.00	18
3	XDMJSL03E	0	189.00	30
4	XDMJSL04E	24	242.00	45
6	XDMJSL06E	27	350.00	65
8	XDMJSL08E	27	442.00	85
10	XDMJSL10E	12	718.00	115
12	XDMJSL12E	12	832.00	145
14	XDMJSL14E	2	1,285.00	195
16	XDMJSL16E	2	1,525.00	235
18	XDMJSL18E	0	2,079.00	285
20	XDMJSL20E	2	2,113.00	325
24	XDMJSL24E	0	2,777.00	425
30	XDMJSL30E	0	6,433.00	1088
36	XDMJSL36E	0	8,688.00	1052
42	XDMJSL42E	0	9,709.00	1550
48	XDMJSL48E	0	15,468.00	1940

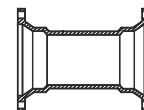
**MJ SHORT SLEEVES**

Size (in)	Item No.	Crt. Qty.	List Price (\$)	Wt. (lb.)
2	XDMJSS02E	48	110.00	12
3	XDMJSS03E		243.00	25
4	XDMJSS04E	4	213.00	35
6	XDMJSS06E	4	244.00	45
8	XDMJSS08E	27	350.00	65
10	XDMJSS10E	4	516.00	85
12	XDMJSS12E	12	674.00	110
14	XDMJSS14E		1,504.00	150
16	XDMJSS16E		1,147.00	180
18	XDMJSS18E		1,417.00	215
20	XDMJSS20E		1,580.00	240
24	XDMJSS24E		2,440.00	320
30	XDMJSS30E		5,255.00	635
36	XDMJSS36E		7,174.00	855
42	XDMJSS42E		8,203.00	1115
48	XDMJSS48E		12,325.00	1385

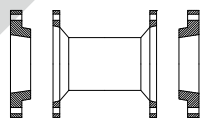
**MJ DUAL PURPOSE SLEEVES**

Size (in)	Item No.	Crt. Qty.	List Price (\$)	Wt. (lb.)
4	XDMJSSDP04E	24	505.00	35
6	XDMJSSDP06E	18	396.00	45
8	XDMJSSDP08E	0	522.00	65

CALL FOR BARE/BARE FITTINGS

**REDUCERS : MJ X MJ**

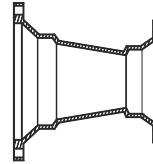

Size (in)	Item No.	Crt. Qty.	List Price (\$)	Wt. (lb.)
3 X 2	XDMJR0302E	60	187.00	26
4 X 2	XDMJR0402E	48	196.00	30
4 X 3	XDMJR0403E	48	240.00	40
6 X 2	XDMJR0602E	24	286.00	45
6 X 3	XDMJR0603E	24	332.00	55
6 X 4	XDMJR0604E	24	322.00	60
8 X 3	XDMJR0803E		578.00	84
8 X 4	XDMJR0804E	16	516.00	80
8 X 6	XDMJR0806E	16	508.00	95
10 X 4	XDMJR1004E		872.00	105
10 X 6	XDMJR1006E	12	697.00	115
10 X 8	XDMJR1008E	12	818.00	135
12 X 4	XDMJR1204E	8	884.00	135
12 X 6	XDMJR1206E	8	1,086.00	150
12 X 8	XDMJR1208E	8	1,022.00	165
12 X 10	XDMJR1210E	8	1,155.00	190
14 X 6	XDMJR1406E	4	1,139.00	190
14 X 8	XDMJR1408E		1,384.00	214
14 X 10	XDMJR1410E		1,514.00	236
14 X 12	XDMJR1412E	2	1,683.00	255
16 X 6	XDMJR1606E		1,514.00	230
16 X 8	XDMJR1608E		2,017.00	250
16 X 10	XDMJR1610E		1,835.00	280
16 X 12	XDMJR1612E		2,203.00	305
16 X 14	XDMJR1614E		2,206.00	335
18 X 8	XDMJR1808E		1,943.00	295
18 X 10	XDMJR1810E		2,142.00	325
18 X 12	XDMJR1812E		2,303.00	350
18 X 14	XDMJR1814E		2,502.00	380
18 X 16	XDMJR1816E		2,733.00	415
20 X 8	XDMJR2008E		4,380.00	345
20 X 10	XDMJR2010E		2,440.00	375
20 X 12	XDMJR2012E		2,667.00	405
20 X 14	XDMJR2014E		3,852.00	435
20 X 16	XDMJR2016E		3,093.00	470
20 X 18	XDMJR2018E		3,356.00	510
24 X 12	XDMJR2412E		3,618.00	550
24 X 16	XDMJR2416E		4,048.00	615
24 X 18	XDMJR2418E		4,342.00	660

Size (in)	Item No.	Crt. Qty.	List Price (\$)	Wt. (lb.)
24 X 20	XDMJR2420E		4,639.00	705
30 X 12	XDMJR3012E		7,046.00	920
30 X 16	XDMJR3016E		6,864.00	985
30 X 18	XDMJR3018E		6,898.00	990
30 X 20	XDMJR3020E		7,317.00	1050
30 X 24	XDMJR3024E		8,118.00	1165
36 X 20	XDMJR3620E		10,103.00	1450
36 X 24	XDMJR3624E		11,006.00	1580
36 X 30	XDMJR3630E		12,924.00	1855
42 X 20	XDMJR4220E		14,087.00	1928
42 X 24	XDMJR4224E		15,150.00	2060
42 X 30	XDMJR4230E		17,432.00	2370
42 X 36	XDMJR4236E		19,824.00	2714
48 X 30	XDMJR4830E		22,103.00	3005
48 X 36	XDMJR4836E		24,787.00	3385
48 X 42	XDMJR4842E		27,580.00	3776

**REDUCERS : FE X MJ**

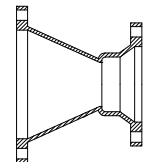

Size (in)	Item No.	Crt. Qty.	List Price (\$)	Wt. (lb.)
4 X 3	FXDMJR0403E	0	209.00	34
6 X 4	FXDMJR0604E	0	316.00	60
8 X 4	FXDMJR0804E	0	430.00	80
8 X 6	FXDMJR0806E	0	520.00	89
10 X 6	FXDMJR1006E	0	682.00	114
10 X 8	FXDMJR1008E	0	753.00	130
12 X 6	FXDMJR1206E	0	845.00	151
12 X 8	FXDMJR1208E	0	996.00	183
12 X 10	FXDMJR1210E	0	1,087.00	190
16 X 12	FXDMJR1612E	0	1,844.00	305

CALL FOR BARE/BARE FITTINGS

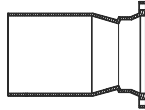
**REDUCERS : MJ  
SMALL END (SEB)**

Size (in)	Item No.	Crt. Qty.	List Price (\$)	Wt. (lb.)
3 X 2	XDMJRS0302E	48	258.00	14
4 X 2	XDMJRS0402E	48	222.00	18
4 X 3	XDMJRS0403E		218.00	35
6 X 2	XDMJRS0602E	26	300.00	45
6 X 3	XDMJRS0603E		312.00	50
6 X 4	XDMJRS0604E		373.00	60
8 X 3	XDMJRS0803E		475.00	77
8 X 4	XDMJRS0804E	16	497.00	80
8 X 6	XDMJRS0806E	16	559.00	90
10 X 6	XDMJRS1006E		714.00	115
10 X 8	XDMJRS1008E		807.00	130
12 X 4	XDMJRS1204E		807.00	130
12 X 6	XDMJRS1206E		930.00	150
12 X 8	XDMJRS1208E	12	1,025.00	165
12 X 10	XDMJRS1210E		1,179.00	190
16 X 8	XDMJRS1608E		1,514.00	230
16 X 12	XDMJRS1612E		1,877.00	285
16 X 14	XDMJRS1614E		3,439.00	310
18 X 12	XDMJRS1812E		2,142.00	325
20 X 8	XDMJRS2008E		4,286.00	345
20 X 12	XDMJRS2012E		2,470.00	375
20 X 16	XDMJRS2016E		2,863.00	435
20 X 18	XDMJRS2018E		4,286.00	345
24 X 12	XDMJRS2412E		3,356.00	510
24 X 14	XDMJRS2414E		5,486.00	535
24 X 16	XDMJRS2416E		3,784.00	575
24 X 18	XDMJRS2418E		4,079.00	620
24 X 20	XDMJRS2420E		4,375.00	665
30 X 16	XDMJRS3016E		6,269.00	900
30 X 18	XDMJRS3018E		6,167.00	885
30 X 20	XDMJRS3020E		6,585.00	945
30 X 24	XDMJRS3024E		7,384.00	1060
36 X 20	XDMJRS3620E		14,465.00	1285
36 X 24	XDMJRS3624E		16,342.00	1410
36 X 30	XDMJRS3630E		11,774.00	1690
42 X 30	XDMJRS4230E		22,672.00	2165
42 X 36	XDMJRS4236E		24,408.00	2485
48 X 36	XDMJRS4836E		22,799.00	3100

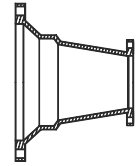
**REDUCERS : MJ X FE**

Size (in)	Item No.	Crt. Qty.	List Price (\$)	Wt. (lb.)
4 X 3	XDMJFR0403E	0	215.00	35
6 X 3	XDMJFR0603E	0	326.00	49
6 X 4	XDMJFR0604E	0	343.00	54
8 X 4	XDMJFR0804E	0	463.00	75
8 X 6	XDMJFR0806E	2	504.00	80
10 X 6	XDMJFR1006E	0	584.00	105
10 X 8	XDMJFR1008E	0	753.00	130
12 X 6	XDMJFR1206E	0	770.00	145
12 X 8	XDMJFR1208E	0	1,082.00	175
12 X 10	XDMJFR1210E	0	1,070.00	185
14 X 6	XDMJFR1406E	0	1,178.00	195
14 X 8	XDMJFR1408E	0	1,420.00	215
14 X 12	XDMJFR1412E	0	1,482.00	270
16 X 12	XDMJFR1612E	0	2,233.00	325
18 X 8	XDMJFR1808E	0	1,975.00	300
18 X 12	XDMJFR1812E	0	2,616.00	360
18 X 16	XDMJFR1816E	0	2,929.00	445
20 X 16	XDMJFR2016E	0	3,356.00	510
24 X 12	XDMJFR2412E	0	4,353.00	455

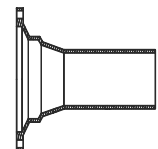
**REDUCERS : MJ  
LARGE END (LEB)**

Size (in)	Item No.	Crt. Qty.	List Price (\$)	Wt. (lb.)
4 X 3	XDMJRL0403E		248.00	40
6 X 3	XDMJRL0603E		343.00	55
6 X 4	XDMJRL0604E		373.00	60
8 X 3	XDMJRL0803E		466.00	70
8 X 4	XDMJRL0804E		497.00	80
8 X 6	XDMJRL0806E		610.00	98
10 X 6	XDMJRL1006E		714.00	115
10 X 8	XDMJRL1008E		807.00	130
12 X 4	XDMJRL1204E		1,129.00	135
12 X 6	XDMJRL1206E		900.00	145
12 X 8	XDMJRL1208E		1,025.00	165
12 X 10	XDMJRL1210E		1,149.00	185

Contd.....

CALL FOR BARE/BARE FITTINGS

**REDUCERS : MJ  
LARGE END (LEB)**

Contd.....

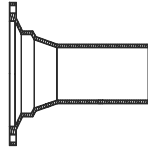

Size (in)	Item No.	Crt. Qty.	List Price (\$)	Wt. (lb.)
16 X 8	XDMJRL1608E		2,602.00	
16 X 10	XDMJRL1610E		2,826.00	
16 X 12	XDMJRL1612E		2,009.00	305
20 X 10	XDMJRL2010E		3,360.00	375
20 X 16	XDMJRL2016E		2,929.00	445
24 X 16	XDMJRL2416E		3,916.00	595
24 X 20	XDMJRL2420E		4,442.00	675
30 X 16	XDMJRL3016E		9,235.00	910
30 X 18	XDMJRL3018E		9,387.00	965
30 X 20	XDMJRL3020E		7,106.00	1020
30 X 24	XDMJRL3024E		7,838.00	1125
36 X 20	XDMJRL3620E		9,892.00	1420
36 X 24	XDMJRL3624E		10,695.00	1535
36 X 30	XDMJRL3630E		11,727.00	1750
42 X 30	XDMJRL4230E		24,590.00	2265
42 X 36	XDMJRL4236E		27,276.00	2530
48 X 42	XDMJRL4842E		45,327.00	3540

**ADAPTERS : MJ X FLANGE**

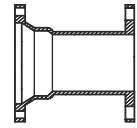

Size (in)	Item No.	Crt. Qty.	List Price (\$)	Wt. (lb.)
3	XDMJFA03E		189.00	30
4	XDMJFA04E	16	248.00	40
6	XDMJFA06E	8	373.00	60
8	XDMJFA08E	8	532.00	85
10	XDMJFA10E		846.00	115
12	XDMJFA12E		1,064.00	155
14	XDMJFA14E	4	1,285.00	195
16	XDMJFA16E		1,712.00	240
18	XDMJFA18E		1,995.00	280
20	XDMJFA20E		2,404.00	340
24	XDMJFA24E		3,013.00	455
30	XDMJFA30E		5,295.00	760
36	XDMJFA36E		7,455.00	1070
42	XDMJFA42E		11,072.00	1505
48	XDMJFA48E		14,273.00	1942

**HYDRANT ADAPTERS :  
SWIVEL X SOLID  
WITH SWIVEL GLAND  
(ANCHOR COUPLING)**

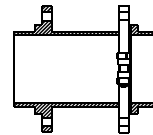

**HYDRANT ELL :  
SWIVEL X SWIVEL  
WITH TWO-SWIVEL GLAND**

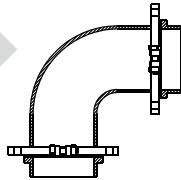

Size (in)	Item No.	Crt. Qty.	List Price (\$)	Wt. (lb.)
6	XDMJHB9006E	0	POA	87
8	XDMJHB9008E	0	POA	158

Size (in)	Item No.	Crt. Qty.	List Price (\$)	Wt. (lb.)
4 X 13	XDMJHA0413E	60	POA	28
6 X 13	XDMJHA0613E		POA	54
6 X 18	XDMJHA0618E		POA	68
6 X 24	XDMJHA0624E		POA	81
6 X 36	XDMJHA0636E		POA	110
6 X 48	XDMJHA0648E		POA	139
8 X 13	XDMJHA0813E	27	POA	68
8 X 18	XDMJHA0818E		POA	88
8 X 24	XDMJHA0824E		POA	112
8 X 48	XDMJHA0848E		POA	208
12 X 13	XDMJHA1213E	12	POA	123

CALL FOR BARE/BARE FITTINGS

**MJ CAPS : SOLID**

Size (in)	Item No.	Crt. Qty.	List Price (\$)	Wt. (lb.)
2	XDMJC02E	100	58.00	5
3	XDMJC03E	50	75.00	12
4	XDMJC04E	18	93.00	20
6	XDMJC06E	18	138.00	30
8	XDMJC08E	18	237.00	45
10	XDMJC10E	8	365.00	60
12	XDMJC12E	8	490.00	80
14	XDMJC14E	2	936.00	110
16	XDMJC16E	2	988.00	155
18	XDMJC18E	2	1,140.00	185
20	XDMJC20E	2	1,562.00	200
24	XDMJC24E	2	2,272.00	300
30	XDMJC30E	0	4,113.00	590
36	XDMJC36E	0	5,924.00	815
42	XDMJC42E	0	8,679.00	1180
48	XDMJC48E	0	11,733.00	1595

**MJ CAPS : 2" TAPPED**

Size (in)	Item No.	Crt. Qty.	List Price (\$)	Wt. (lb.)
2	XDMJC02TE	0	97.00	5
3	XDMJC03TE	0	114.00	12
4	XDMJC04TE	0	125.00	20
6	XDMJC06TE	18	182.00	30
8	XDMJC08TE	18	283.00	45
10	XDMJC10TE	0	403.00	60
12	XDMJC12TE	8	529.00	80
14	XDMJC14TE	0	998.00	110
16	XDMJC16TE	0	1,057.00	155
18	XDMJC18TE	0	1,150.00	185
20	XDMJC20TE	0	1,512.00	200
24	XDMJC24TE	0	2,149.00	300
30	XDMJC30TE	0	4,228.00	590
36	XDMJC36TE	0	6,040.00	815
42	XDMJC42TE	0	8,758.00	1180
48	XDMJC48TE	0	11,889.00	1595

**MJ PLUGS : SOLID**



Size (in)	Item No.	Crt. Qty.	List Price (\$)	Wt. (lb.)
2	XDMJP02E	24	56.00	5
3	XDMJP03E	0	63.00	10
4	XDMJP04E	18	93.00	20
6	XDMJP06E	18	152.00	30
8	XDMJP08E	12	272.00	50
10	XDMJP10E	8	396.00	65
12	XDMJP12E	8	522.00	85
14	XDMJP14E	0	760.00	115
16	XDMJP16E	2	949.00	145
18	XDMJP18E	0	895.00	180
20	XDMJP20E	0	1,562.00	200
24	XDMJP24E	0	2,267.00	290
30	XDMJP30E	0	4,008.00	575
36	XDMJP36E	0	5,679.00	815
42	XDMJP42E	0	8,166.00	1110
48	XDMJP48E	0	10,703.00	1455

**MJ PLUGS : 2" TAPPED**

Size (in)	Item No.	Crt. Qty.	List Price (\$)	Wt. (lb.)
3	XDMJP03TE	0	100.00	10
4	XDMJP04TE	18	125.00	20
6	XDMJP06TE	120	182.00	30
8	XDMJP08TE	100	288.00	50
10	XDMJP10TE	8	402.00	65
12	XDMJP12TE	40	517.00	85
14	XDMJP14TE	0	823.00	115
16	XDMJP16TE	0	1,002.00	145
18	XDMJP18TE	0	867.00	180
20	XDMJP20TE	0	1,523.00	200
24	XDMJP24TE	0	2,285.00	290
30	XDMJP30TE	0	3,878.00	575
36	XDMJP36TE	0	5,796.00	815
42	XDMJP42TE	0	9,143.00	1110
48	XDMJP48TE	0	12,168.00	1455

CALL FOR BARE/BARE FITTINGS

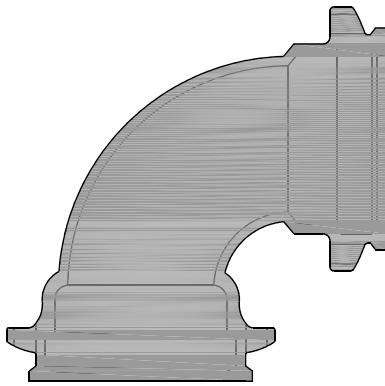
# Utility Pipe Fittings Fusion Bonded Epoxy



ANSI/AWWA C153/A21.53  
**COMPACT PUSH-ON FITTINGS**  
**FUSION BONDED EPOXY**

**PRICE LIST**  
Effective January 14, 2019.



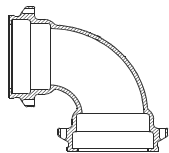

**BENDS : PO X PO  
90° (1/4)**

Size (in)	Item No.	Crt. Qty.	List Price (\$)	Wt. (lb.)
4	CDPOB9004E	60	210.00	28
6	CDPOB9006E	32	334.00	44
8	CDPOB9008E	18	495.00	71
10	CDPOB9010E	12	650.00	100
12	CDPOB9012E	6	1,074.00	140
14	CDPOB9014E	0	1,562.00	254
16	CDPOB9016E	4	2,793.00	280
18	CDPOB9018E	0	3,663.00	482
20	CDPOB9020E	0	4,100.00	640
24	CDPOB9024E	2	5,118.00	710

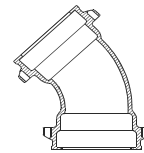
**BENDS : PO X PO  
45° (1/8)**

Size (in)	Item No.	Crt. Qty.	List Price (\$)	Wt. (lb.)
4	CDPOB4504E	75	190.00	23
6	CDPOB4506E	36	283.00	38
8	CDPOB4508E	27	414.00	54
10	CDPOB4510E	18	620.00	84
12	CDPOB4512E	8	827.00	110
14	CDPOB4514E		1,238.00	150
16	CDPOB4516E	4	1,954.00	210
18	CDPOB4518E		2,134.00	309
20	CDPOB4520E		3,015.00	397
24	CDPOB4524E		3,737.00	455

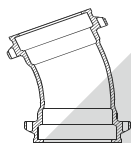
**BENDS : PO X PO  
22½° (1/16)**

Size (in)	Item No.	Crt. Qty.	List Price (\$)	Wt. (lb.)
4	CDPOB2204E	75	182.00	22
6	CDPOB2206E	48	252.00	34
8	CDPOB2208E	27	352.00	55
10	CDPOB2210E	18	525.00	70
12	CDPOB2212E	8	703.00	90
14	CDPOB2214E		1,238.00	162
16	CDPOB2216E	4	1,819.00	220
18	CDPOB2218E		2,329.00	209
20	CDPOB2220E		3,146.00	414
24	CDPOB2224E		4,290.00	455

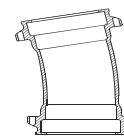
**BENDS : PO X PO  
11¼° (1/32)**

Size (in)	Item No.	Crt. Qty.	List Price (\$)	Wt. (lb.)
4	CDPOB1104E	75	179.00	21
6	CDPOB1106E	48	247.00	32
8	CDPOB1108E	25	345.00	52
10	CDPOB1110E	18	510.00	70
12	CDPOB1112E	8	680.00	95
14	CDPOB1114E		1,238.00	113
16	CDPOB1116E	4	1,842.00	170
18	CDPOB1118E		2,343.00	209
20	CDPOB1120E		2,854.00	265
24	CDPOB1124E	2	5,677.00	315

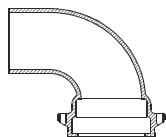
**BENDS : PO X PE  
90° (1/4)**

Size (in)	Item No.	Crt. Qty.	List Price (\$)	Wt. (lb.)
4	CDPOPB9004E	60	382.00	24
6	CDPOPB9006E	32	362.00	48
8	CDPOPB9008E		POA	

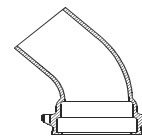
**BENDS : PO X PE  
45° (1/8)**

Size (in)	Item No.	Crt. Qty.	List Price (\$)	Wt. (lb.)
4	CDPOPB4504E	75	138.00	21
6	CDPOPB4506E	36	293.00	38
8	CDPOPB4508E	27	458.00	60

CALL FOR BARE/BARE FITTINGS



**BENDS : PO X PE**  
**22½° (1/16)**

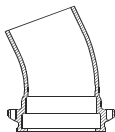

Size (in)	Item No.	Crt. Qty.	List Price (\$)	Wt. (lb.)
4	CDPOPB2204E		POA	
6	CDPOPB2206E	48	269.00	35
8	CDPOPB2208E	27	436.00	57

**BENDS : PO X PE**  
**11¼° (1/32)**

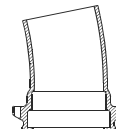

Size (in)	Item No.	Crt. Qty.	List Price (\$)	Wt. (lb.)
4	CDPOPB1104E		POA	
6	CDPOPB1106E	48	276.00	35
8	CDPOPB1108E	27	422.00	55

**BENDS : PO X FE**  
**90° (1/4)**

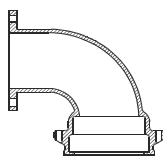

Size (in)	Item No.	Crt. Qty.	List Price (\$)	Wt. (lb.)
4	CDPOFB9004E	24	185.00	32
6	CDPOFB9006E	36	465.00	49
8	CDPOFB9008E	18	525.00	74
10	CDPOFB9010E	16	872.00	130
12	CDPOFB9012E	16	1,316.00	158
14	CDPOFB9014E	0	1,210.00	231
16	CDPOFB9016E	4	1,770.00	233

**BENDS : PO X FE**  
**45° (1/8)**

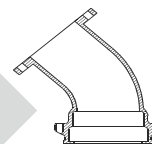

Size (in)	Item No.	Crt. Qty.	List Price (\$)	Wt. (lb.)
4	CDPOFB4504E	0	163.00	21
6	CDPOFB4506E	36	357.00	42
8	CDPOFB4508E	18	547.00	60
10	CDPOFB4510E	0	709.00	93
12	CDPOFB4512E	0	1,022.00	122
14	CDPOFB4514E	0	1,233.00	162
16	CDPOFB4516E	0	2,092.00	275

**BENDS : PO X FE**  
**22½° (1/16)**

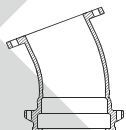

Size (in)	Item No.	Crt. Qty.	List Price (\$)	Wt. (lb.)
4	CDPOFB2204E	48	204.00	25
6	CDPOFB2206E	36	267.00	44
8	CDPOFB2208E	24	444.00	64
10	CDPOFB2210E	12	625.00	90
12	CDPOFB2212E	8	1,014.00	112
14	CDPOFB2214E		1,233.00	174
16	CDPOFB2216E		2,092.00	228

**BENDS : PO X FE**  
**11¼° (1/32)**

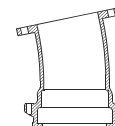

Size (in)	Item No.	Crt. Qty.	List Price (\$)	Wt. (lb.)
4	CDPOFB1104E	48	185.00	24
6	CDPOFB1106E	36	267.00	30
8	CDPOFB1108E	27	448.00	60
10	CDPOFB1110E	12	586.00	80
12	CDPOFB1112E	8	872.00	96
14	CDPOFB1114E		1,294.00	170
16	CDPOFB1116E		1,735.00	230

CALL FOR BARE/BARE FITTINGS

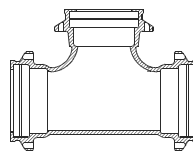
**TEES : PO X PO**

Size (in)	Item No.	Crt. Qty.	List Price (\$)	Wt. (lb.)
4 X 4	CDPOT0404E	48	297.00	46
6 X 4	CDPOT0604E	24	376.00	58
6 X 6	CDPOT0606E	24	419.00	66
8 X 4	CDPOT0804E	16	505.00	93
8 X 6	CDPOT0806E	18	573.00	103
8 X 8	CDPOT0808E	18	682.00	109
10 X 4	CDPOT1004E	18	773.00	95
10 X 6	CDPOT1006E	12	846.00	129
10 X 8	CDPOT1008E	8	994.00	141
10 X 10	CDPOT1010E	8	1,233.00	145
12 X 4	CDPOT1204E	12	960.00	115
12 X 6	CDPOT1206E	8	898.00	164
12 X 8	CDPOT1208E	8	1,092.00	166
12 X 10	CDPOT1210E	4	1,245.00	175
12 X 12	CDPOT1212E	4	1,233.00	193
14 X 6	CDPOT1406E		1,216.00	176
14 X 10	CDPOT1410E		2,468.00	195
14 X 12	CDPOT1412E		2,502.00	196
14 X 14	CDPOT1414E		2,630.00	209
16 X 6	CDPOT1606E	2	2,277.00	231
16 X 8	CDPOT1608E	4	2,476.00	265
16 X 10	CDPOT1610E		2,577.00	232
16 X 12	CDPOT1612E	4	2,933.00	300
16 X 14	CDPOT1614E		3,667.00	349
16 X 16	CDPOT1616E	4	3,503.00	261
18 X 6	CDPOT1806E		2,645.00	348
18 X 8	CDPOT1808E		2,470.00	325
18 X 10	CDPOT1810E		2,614.00	344
18 X 12	CDPOT1812E		POA	344
18 X 14	CDPOT1814E		2,599.00	342
18 X 16	CDPOT1816E		2,750.00	362
18 X 18	CDPOT1818E		POA	377
20 X 6	CDPOT2006E		2,698.00	355
20 X 10	CDPOT2010E		2,805.00	369
20 X 12	CDPOT2012E		POA	425
20 X 14	CDPOT2014E		3,677.00	484
20 X 16	CDPOT2016E		4,632.00	510
20 X 18	CDPOT2018E		4,094.00	539
20 X 20	CDPOT2020E		POA	564

Size (in)	Item No.	Crt. Qty.	List Price (\$)	Wt. (lb.)
24 X 6	CDPOT2406E		3,539.00	450
24 X 8	CDPOT2408E		POA	492
24 X 10	CDPOT2410E		3,632.00	478
24 X 12	CDPOT2412E		5,035.00	541
24 X 14	CDPOT2414E		4,115.00	542
24 X 16	CDPOT2416E		4,298.00	566
24 X 18	CDPOT2418E	2	4,504.00	593
24 X 20	CDPOT2420E		4,769.00	628
24 X 24	CDPOT2424E		6,713.00	884

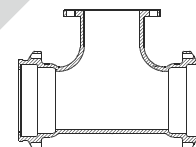
**TEES : PO X FE**

Size (in)	Item No.	Crt. Qty.	List Price (\$)	Wt. (lb.)
4 X 4	CDPOFT0404E	24	320.00	42
6 X 4	CDPOFT0604E	24	412.00	59
6 X 6	CDPOFT0606E	24	434.00	67
8 X 4	CDPOFT0804E	18	553.00	79
8 X 6	CDPOFT0806E	18	573.00	85
8 X 8	CDPOFT0808E	18	694.00	105
10 X 4	CDPOFT1004E	18	740.00	97
10 X 6	CDPOFT1006E	8	956.00	102
10 X 8	CDPOFT1008E	8	1,063.00	128
10 X 10	CDPOFT1010E	8	1,083.00	165
12 X 4	CDPOFT1204E	12	952.00	125
12 X 6	CDPOFT1206E	8	975.00	135
12 X 8	CDPOFT1208E	8	1,127.00	155
12 X 10	CDPOFT1210E	4	1,146.00	142
12 X 12	CDPOFT1212E	4	1,609.00	210
14 X 6	CDPOFT1406E		1,925.00	212
14 X 8	CDPOFT1408E		2,719.00	265
14 X 10	CDPOFT1410E		2,449.00	246
14 X 12	CDPOFT1412E		2,920.00	296
14 X 14	CDPOFT1414E		3,157.00	321
16 X 6	CDPOFT1606E	8	2,066.00	236
16 X 8	CDPOFT1608E	8	2,560.00	269
16 X 10	CDPOFT1610E		2,507.00	330

Contd.....

CALL FOR BARE/BARE FITTINGS

**TEES : PO X FE**  
Contd.....

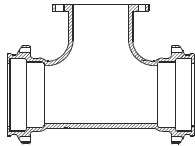

Size (in)	Item No.	Crt. Qty.	List Price (\$)	Wt. (lb.)
16 X 12	CDPOFT1612E	4	2,439.00	348
16 X 14	CDPOFT1614E		3,352.00	342
16 X 16	CDPOFT1616E	4	3,477.00	355
18 X 6	CDPOFT1806E		2,287.00	301
18 X 8	CDPOFT1808E		2,424.00	319
18 X 10	CDPOFT1810E		2,559.00	337
18 X 14	CDPOFT1814E		2,984.00	393
18 X 16	CDPOFT1816E		3,190.00	420
20 X 6	CDPOFT2006E		2,590.00	341
20 X 10	CDPOFT2010E		3,327.00	420
20 X 14	CDPOFT2014E		3,756.00	474
20 X 16	CDPOFT2016E		3,946.00	498
20 X 18	CDPOFT2018E		5,994.00	528
24 X 6	CDPOFT2406E		4,053.00	512
24 X 8	CDPOFT2408E		5,203.00	594
24 X 10	CDPOFT2410E		3,707.00	468
24 X 12	CDPOFT2412E		3,983.00	503
24 X 14	CDPOFT2414E		4,204.00	531
24 X 16	CDPOFT2416E		4,395.00	555

**HYDRANT TEES : PO X SWIVEL**

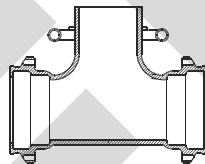

Size (in)	Item No.	Crt. Qty.	List Price (\$)	Wt. (lb.)
6 X 6	CDPOHT0606E	24	456.00	70
8 X 6	CDPOHT0806E	24	760.00	90
8 X 8	CDPOHT0808E		837.00	110
10X 6	CDPOHT1006E		989.00	100
10X 8	CDPOHT1008E		1,187.00	156
12X 6	CDPOHT1206E	16	1,202.00	138
12X 8	CDPOHT1208E		1,203.00	158
14X 6	CDPOHT1406E		1,537.00	202
16X 6	CDPOHT1606E	2	1,742.00	230
16X 8	CDPOHT1608E		2,218.00	292
18X 6	CDPOHT1806E		2,645.00	348
18X 8	CDPOHT1808E		2,462.00	324
20X 6	CDPOHT2006E		3,037.00	400
24X 6	CDPOHT2406E		3,987.00	525

**PO CROSSES**

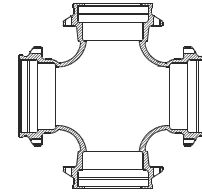

Size (in)	Item No.	Crt. Qty.	List Price (\$)	Wt. (lb.)
4 X 4	CDPOX0404E		456.00	56
6 X 4	CDPOX0604E		543.00	69
6 X 6	CDPOX0606E	12	517.00	83
8 X 4	CDPOX0804E		950.00	117
8 X 6	CDPOX0806E	12	767.00	115
8 X 8	CDPOX0808E	12	872.00	128
10 X 4	CDPOX1004E		963.00	116
10 X 6	CDPOX1006E		1,382.00	
10 X 8	CDPOX1008E		1,655.00	159
10 X 10	CDPOX1010E		1,373.00	165
12 X 8	CDPOX1208E	8	1,220.00	197
12 X 10	CDPOX1210E		1,568.00	195
12 X 12	CDPOX1212E		1,652.00	241
14 X 6	CDPOX1406E		1,439.00	189
14 X 8	CDPOX1408E		1,550.00	204
14 X 10	CDPOX1410E		1,688.00	222
14 X 12	CDPOX 1412E		1,818.00	239
14 X 14	CDPOX1414E		2,052.00	270
16 X 6	CDPOX1606E		1,797.00	234
16 X 8	CDPOX1608E		2,454.00	323
16 X 10	CDPOX1610E		POA	268
16 X 12	CDPOX1612E		2,084.00	274
16 X 14	CDPOX 1614E		POA	322
16 X 16	CDPOX1616E		2,412.00	317
24 X 24	CDPOX2424E		POA	1178

**TEES : PO X PE**

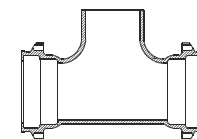

Size (in)	Item No.	Crt. Qty.	List Price (\$)	Wt. (lb.)
6 X 6	CDPOPET0606E	24	566.00	60
8 X 6	CDPOPET0806E	18	860.00	75
12X 6	CDPOPET1206E	8	1272.00	132

CALL FOR BARE/BARE FITTINGS

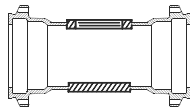
**TEES : PO TAPPED 2"**

Size (in)	Item No.	Crt. Qty.	List Price (\$)	Wt. (lb.)
4	CDCDPOTT04E		244.00	27
6	CDCDPOTT06E		325.00	38
8	CDCDPOTT08E		482.00	59
10	CDCDPOTT10E		575.00	72
12	CDCDPOTT12E		732.00	92

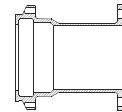
**PO FLANGE ADAPTER**

Size (in)	Item No.	Crt. Qty.	List Price (\$)	Wt. (lb.)
4	CDPOFA04E	80	186.00	22
6	CDPOFA06E	48	285.00	34
8	CDPOFA08E	36	394.00	50
10	CDPOFA10E	24	496.00	70
12	CDPOFA12E	16	757.00	80
14	CDPOFA14E		1,315.00	113
16	CDPOFA16E	8	1,493.00	180
18	CDPOFA18E		2,033.00	226
20	CDPOFA20E		2,243.00	264
24	CDPOFA24E	4	4,094.00	308

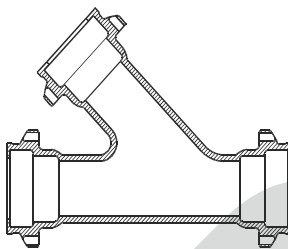
**PO LATERAL WYES**

Size (in)	Item No.	Crt. Qty.	List Price (\$)	Wt. (lb.)
4 X 4	CDPOL0404E	8	290.00	55
6 X 4	CDPOL0604E	8	617.00	75
6 X 6	CDPOL0606E	8	753.00	83
8 X 4	CDPOL0804E		764.00	90
8 X 6	CDPOL0806E	8	1,039.00	125
8 X 8	CDPOL0808E	8	1,219.00	140
10X 4	CDPOL1004E		910.00	141
10X 6	CDPOL1006E		1,154.00	155
10X 8	CDPOL1008E		1,499.00	160
10X10	CDPOL1010E	4	1,395.00	170
12X 4	CDPOL1204E		1,445.00	178
12X 6	CDPOL1206E		1,529.00	234
12X 8	CDPOL1208E		1,678.00	260
12X10	CDPOL1210E		1,839.00	280
12X12	CDPOL1212E	3	1,850.00	300
14X 6	CDPOL1406E		1,794.00	236
14X 8	CDPOL1408E		1,938.00	255
14X10	CDPOL1410E		2,470.00	325
14X14	CDPOL1414E		3,607.00	475
16X 6	CDPOL1606E		2,136.00	281
16X 8	CDPOL1608E		2,310.00	304
16X12	CDPOL1612E		2,628.00	346
16X16	CDPOL1616E		2,886.00	380

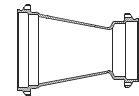
**REDUCERS : PO X PO**

Size (in)	Item No.	Crt. Qty.	List Price (\$)	Wt. (lb.)
6 X 4	CDPOR0604E	60	209.00	30
8 X 4	CDPOR0804E	36	296.00	40
8 X 6	CDPOR0806E	36	305.00	40
10X 4	CDPOR1004E		565.00	55
10X 6	CDPOR1006E		440.00	60
10X 8	CDPOR1008E	18	487.00	65
12X 4	CDPOR1204E	12	620.00	70
12X 6	CDPOR1206E	18	523.00	75
12X 8	CDPOR1208E	12	566.00	80
12X10	CDPOR1210E	12	679.00	107
14X 6	CDPOR1406E		570.00	84
14X 8	CDPOR1408E		577.00	85
14X10	CDPOR1410E		592.00	87
14X12	CDPOR1412E		705.00	104
16X 6	CDPOR1606E	4	1,200.00	138
16X 8	CDPOR1608E	4	1,244.00	137
16X10	CDPOR1610E	4	1,216.00	130
16X12	CDPOR1612E	4	1,283.00	135
16X14	CDPOR1614E		1,058.00	139
18X 8	CDPOR1808E		1,082.00	142
18X10	CDPOR1810E		1,148.00	151
18X12	CDPOR1812E		1,273.00	167
18X14	CDPOR1814E		1,652.00	217

Contd.....

**CALL FOR BARE/BARE FITTINGS**

**REDUCERS : PO X PO**

Contd.....

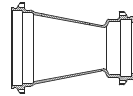

Size (in)	Item No.	Crt. Qty.	List Price (\$)	Wt. (lb.)
18X16	CDPOR1816E		1,537.00	202
20X10	CDPOR2010E		1,368.00	180
20X12	CDPOR2012E		1,560.00	205
20X14	CDPOR2014E		1,770.00	233
20X16	CDPOR2016E		1,900.00	250
20X18	CDPOR2018E		1,886.00	248
24X12	CDPOR2412E		1,870.00	337
24X14	CDPOR2414E		2,136.00	339
24X16	CDPOR2416E		2,886.00	340
24X18	CDPOR2418E		2,963.00	390
24X20	CDPOR2420E		3,198.00	421

**REDUCERS : PO X FE**

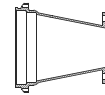

Size (in)	Item No.	Crt. Qty.	List Price (\$)	Wt. (lb.)
6 X 4	CDPOFR0604E	16	257.00	32
8 X 4	CDPOFR0804E	16	374.00	46
8 X 6	CDPOFR0806E	36	378.00	47
10X 4	CDPOFR1004E		422.00	55
10X 6	CDPOFR1006E	12	452.00	59
10X 8	CDPOFR1008E	18	715.00	60
12X 4	CDPOFR1204E		595.00	78
12X 6	CDPOFR1206E	8	574.00	73
12X 8	CDPOFR1208E	8	565.00	74
12X10	CDPOFR1210E		725.00	95
14X 6	CDPOFR1406E		922.00	121
14X 8	CDPOFR1408E		975.00	128
14X10	CDPOFR1410E		969.00	127
14X12	CDPOFR1412E		1,096.00	144
16X 6	CDPOFR1606E		1,013.00	136
16X 8	CDPOFR1608E		1,074.00	144
16X10	CDPOFR1610E		1,203.00	160
16X12	CDPOFR1612E	4	1,307.00	170
16X14	CDPOFR1614E		1,492.00	196
18X 8	CDPOFR1808E		1,196.00	157
18X10	CDPOFR1810E		1,333.00	175
18X12	CDPOFR1812E		1,636.00	215
18X14	CDPOFR1814E		1,779.00	234
18X16	CDPOFR1816E		1,870.00	246
20X10	CDPOFR2010E		1,779.00	234
20X14	CDPOFR2014E		1,895.00	249
20X16	CDPOFR2016E		2,067.00	272
24X12	CDPOFR2412E		1,992.00	262
24X14	CDPOFR2414E		2,393.00	315
24X16	CDPOFR2416E		2,494.00	328

**PUSH-ON GASKET**



Size (in)	Item No.	Crt. Qty.	List Price (\$)	Wt. (lb.)
4	6655.04E	180	POA	0.4
6	6655.06E	100	POA	0.6
8	6655.08E	80	POA	0.7
10	6655.10E	60	POA	0.9
12	6655.12E	60	POA	1
14	6655.14E	60	POA	1.3
16	6655.16E	50	POA	1.5

**TRANSITION PUSH-ON GASKET**



Size (in)	Item No.	Crt. Qty.	List Price (\$)	Wt. (lb.)
4	6656.04E	180	POA	0.4
6	6656.06E	100	POA	0.6
8	6656.08E	80	POA	0.7
10	6656.10E	60	POA	0.9
12	6656.12E	60	POA	1.0

CALL FOR BARE/BARE FITTINGS

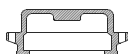

**PO CAPS SOLID**

Size (in)	Item No.	Crt. Qty.	List Price (\$)	Wt. (lb.)
4	CDPOC04E	120	93.00	13
6	CDPOC06E	72	139.00	20
8	CDPOC08E	54	215.00	32
10	CDPOC10E	36	284.00	40
12	CDPOC12E	24	400.00	63
14	CDPOC14E		POA	70
16	CDPOC16E	12	POA	110
18	CDPOC18E		POA	120
20	CDPOC20E		POA	150
24	CDPOC24E	4	POA	216

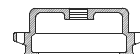
**PO CAPS TAPPED**

Size (in)	Item No.	Crt. Qty.	List Price (\$)	Wt. (lb.)
4	CDPOCT04E	120	132.00	13
6	CDPOCT06E	72	179.00	20
8	CDPOCT08E	54	255.00	32
10	CDPOCT10E	36	324.00	40
12	CDPOCT12E	24	439.00	63
14	CDPOCT14E		POA	70
16	CDPOCT16E	12	POA	110
18	CDPOCT18E		POA	120
20	CDPOCT20E		POA	150
24	CDPOCT24E		POA	216

**PO PLUGS SOLID**

Size (in)	Item No.	Crt. Qty.	List Price (\$)	Wt. (lb.)
4	CDPOP04E	200	70.00	12
6	CDPOP06E	96	120.00	18
8	CDPOP08E	72	164.00	29
10	CDPOP10E	36	246.00	35
12	CDPOP12E	30	284.00	46
14	CDPOP14E		764.00	74
16	CDPOP16E	20	2,343.00	60
18	CDPOP18E		2,454.00	120
20	CDPOP20E		2,667.00	145
24	CDPOP24E	4	2,847.00	204

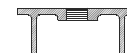
**PO PLUGS TAPPED**

Size (in)	Item No.	Crt. Qty.	List Price (\$)	Wt. (lb.)
4	CDPOPT04E	100	94.00	12
6	CDPOPT06E	72	160.00	18
8	CDPOPT08E	54	203.00	29
10	CDPOPT10E	36	286.00	35
12	CDPOPT12E	24	322.00	46
14	CDPOPT14E		956.00	74
16	CDPOPT16E	8	2,742.00	60
18	CDPOPT18E		2,799.00	120
20	CDPOPT20E		2,964.00	145
24	CDPOPT24E	4	3,485.00	204

CALL FOR BARE/BARE FITTINGS



# Utility Pipe Fittings Fusion Bonded Epoxy

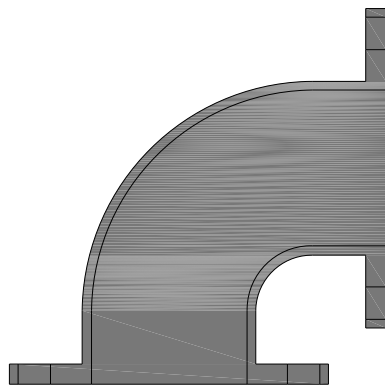

ANSI/AWWA C110/A21.10  
**FLANGE FITTINGS**  
**FUSION BONDED EPOXY**

**PRICE LIST**  
Effective January 14, 2019.

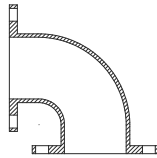

**FLANGE BENDS**  
**90° (1/4)**

Size (in)	Item No.	List Price (\$)	Wt. (lb.)
2	DFB9002E	120.00	14
3	DFB9003E	152.00	25
4	DFB9004E	234.00	45
6	DFB9006E	362.00	65
8	DFB9008E	595.00	105
10	DFB9010E	939.00	165
12	DFB9012E	1,217.00	235
14	DFB9014E	1,594.00	290
16	DFB9016E	1,974.00	370
18	DFB9018E	2,609.00	450
20	DFB9020E	3,203.00	580
24	DFB9024E	5,250.00	900
30	DFB9030E	9,016.00	1430
36	DFB9036E	13,362.00	2135
42	DFB9042E	22,482.00	3055
48	DFB9048E	30,119.00	4095
54	DFB9054E	POA	3740

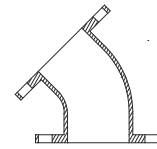
**FLANGE BENDS**  
**45° (1/8)**

Size (in)	Item No.	List Price (\$)	Wt. (lb.)
2	DFB4502E	123.00	12
3	DFB4503E	117.00	20
4	DFB4504E	207.00	40
6	DFB4506E	320.00	55
8	DFB4508E	492.00	90
10	DFB4510E	790.00	130
12	DFB4512E	1,029.00	195
14	DFB4514E	1,218.00	220
16	DFB4516E	1,548.00	280
18	DFB4518E	2,014.00	325
20	DFB4520E	2,700.00	430
24	DFB4524E	3,736.00	630
30	DFB4530E	7,803.00	1120
36	DFB4536E	12,227.00	1755
42	DFB4542E	19,122.00	2600
48	DFB4548E	26,330.00	3580
54	DFB4554E	POA	2735

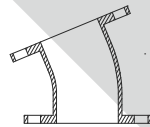
**FLANGE BENDS**  
**22½° (1/16)**

Size (in)	Item No.	List Price (\$)	Wt. (lb.)
2	DFB2202E	162.00	12
3	DFB2203E	127.00	20
4	DFB2204E	206.00	40
6	DFB2206E	307.00	55
8	DFB2208E	480.00	90
10	DFB2210E	756.00	135
12	DFB2212E	1,104.00	205
14	DFB2214E	1,395.00	225
16	DFB2216E	1,600.00	285
18	DFB2218E	2,076.00	335
20	DFB2220E	2,863.00	435
24	DFB2224E	4,209.00	640
30	DFB2230E	7,908.00	1135
36	DFB2236E	12,470.00	1790
42	DFB2242E	19,603.00	2665
48	DFB2248E	26,957.00	3665
54	DFB2254E	POA	2260

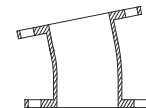
**FLANGE BENDS**  
**11¼° (1/32)**

Size (in)	Item No.	List Price (\$)	Wt. (lb.)
2	DFB1102E	162.00	12
3	DFB1103E	127.00	20
4	DFB1104E	240.00	40
6	DFB1106E	372.00	55
8	DFB1108E	507.00	90
10	DFB1110E	838.00	135
12	DFB1112E	1,273.00	205
14	DFB1114E	1,450.00	225
16	DFB1116E	1,767.00	285
18	DFB1118E	2,076.00	335
20	DFB1120E	2,863.00	435
24	DFB1124E	4,425.00	645
30	DFB1130E	8,013.00	1150
36	DFB1136E	12,575.00	1805
42	DFB1142E	19,712.00	2680
48	DFB1148E	27,177.00	3695
54	DFB1154E	POA	2100

CALL FOR BARE/BARE FITTINGS

**90° LONG RADIUS BENDS**

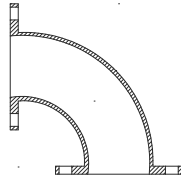

Size (in)	Item No.	List Price (\$)	Wt. (lb.)
3	DFBLR9003E	189.00	30
4	DFBLR9004E	318.00	30
6	DFBLR9006E	547.00	80
8	DFBLR9008E	908.00	140
10	DFBLR9010E	1,333.00	215
12	DFBLR9012E	2,014.00	325
14	DFBLR9014E	2,385.00	580
16	DFBLR9016E	3,128.00	740
18	DFBLR9018E	3,899.00	840
20	DFBLR9020E	5,328.00	928
24	DFBLR9024E	8,155.00	1640
30	DFBLR9030E	14,664.00	2105
36	DFBLR9036E	22,883.00	3285
42	DFBLR9042E	35,783.00	4865
48	DFBLR9048E	49,939.00	7800
54	DFBLR9054E	POA	6205

**90° FLANGE X FLARE BENDS**

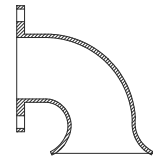

Size (in)	Item No.	List Price (\$)	Wt. (lb.)
3	DFF9003E	159.00	25
4	DFF9004E	283.00	40
6	DFF9006E	436.00	70
8	DFF9008E	744.00	110
10	DFF9010E	1,210.00	175
12	DFF9012E	1,519.00	245
14	DFF9014E	2,105.00	340
16	DFF9016E	2,848.00	460
18	DFF9018E	3,467.00	560
20	DFF9020E	4,604.00	700
24	DFF9024E	6,663.00	1100
30	DFF9030E	13,724.00	1840
36	DFF9036E	19,016.00	2700
42	DFF9042E	23,536.00	3250
48	DFF9048E	38,503.00	4215
54	DFF9054E	POA	3965

**STRAIGHT FLANGE X FLARE**

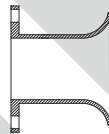

Size (in)	Item No.	List Price (\$)	Wt. (lb.)
3	DFP03E	127.00	20
4	DFP04E	189.00	30
6	DFP06E	248.00	40
8	DFP08E	436.00	70
10	DFP10E	590.00	95
12	DFP12E	962.00	115
14	DFP14E	1,025.00	190
16	DFP16E	1,487.00	330
18	DFP18E	1,705.00	355
20	DFP20E	2,344.00	460
24	DFP24E	3,158.00	635
30	DFP30E	7,663.00	1025
36	DFP36E	10,170.00	1460
42	DFP42E	12,873.00	1900
48	DFP48E	17,469.00	2350
54	DFP54E	POA	2035

**LONG RADIUS 90° FLANGE X FLARE BENDS**

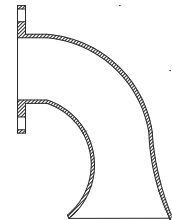

Size (in)	Item No.	List Price (\$)	Wt. (lb.)
3	DFFLR9003E	218.00	30
4	DFFLR9004E	312.00	50
6	DFFLR9006E	559.00	90
8	DFFLR9008E	962.00	115
10	DFFLR9010E	1,550.00	250
12	DFFLR9012E	2,323.00	375
14	DFFLR9014E	3,095.00	500
16	DFFLR9016E	4,425.00	715
18	DFFLR9018E	4,950.00	800
20	DFFLR9020E	7,496.00	1140
24	DFFLR9024E	8,782.00	1335
30	DFFLR9030E	15,255.00	2190
36	DFFLR9036E	24,137.00	3465
42	DFFLR9042E	37,877.00	5150
48	DFFLR9048E	49,460.00	6725

CALL FOR BARE/BARE FITTINGS

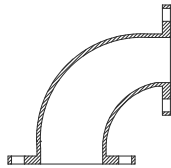
**90° REDUCING BENDS**

Size (in)	Item No.	List Price (\$)	Wt. (lb.)
4 X 3	DFBR0403E	184.00	35
6 X 3	DFBR0603E	348.00	45
6 X 4	DFBR0604E	343.00	55
6 X 5	DFBR0605E	348.00	
8 X 4	DFBR0804E	467.00	80
8 X 6	DFBR0806E	532.00	90
10X 4	DFBR1004E	807.00	105
10X 6	DFBR1006E	838.00	125
10X 8	DFBR1008E	930.00	150
12X 4	DFBR1204E	868.00	
12X 6	DFBR1206E	992.00	165
12X 8	DFBR1208E	1,168.00	190
12X10	DFBR1210E	1,238.00	220
14X 6	DFBR1406E	1,179.00	144
14X 8	DFBR1408E	1,333.00	200
14X10	DFBR1410E	1,487.00	260
14X12	DFBR1412E	1,674.00	270
16X 6	DFBR1606E	1,363.00	220
16X 8	DFBR1608E	1,487.00	240
16X10	DFBR1610E	1,735.00	344
16X12	DFBR1612E	1,920.00	373
16X14	DFBR1614E	2,076.00	330
18X 6	DFBR1806E	1,610.00	260
18X 8	DFBR1808E	2,018.00	280
18X10	DFBR1810E	2,045.00	320
18X12	DFBR1812E	2,169.00	465
18X14	DFBR1814E	2,385.00	370
18X16	DFBR1816E	2,599.00	410
20X 6	DFBR2006E	2,107.00	320
20X 8	DFBR2008E	2,272.00	345
20X10	DFBR2010E	2,929.00	385
20X12	DFBR2012E	2,989.00	415
20X14	DFBR2014E	3,338.00	518
20X16	DFBR2016E	3,258.00	533
20X18	DFBR2018E	3,456.00	515
24X 6	DFBR2406E	3,158.00	480
24X 8	DFBR2408E	3,325.00	505
24X10	DFBR2410E	3,586.00	545
24X12	DFBR2412E	3,784.00	575
24X14	DFBR2414E	4,178.00	595

Size (in)	Item No.	List Price (\$)	Wt. (lb.)
24X16	DFBR2416E	4,507.00	635
24X18	DFBR2418E	4,549.00	675
24X20	DFBR2420E	4,867.00	740
30X12	DFBR3012E	5,852.00	840
30X14	DFBR3014E	7,206.00	860
30X16	DFBR3016E	6,269.00	900
30X18	DFBR3018E	9,306.00	940
30X20	DFBR3020E	9,870.00	1005
30X24	DFBR3024E	8,396.00	1165
36X12	DFBR3612E	8,326.00	1195
36X14	DFBR3614E	10,655.00	1215
36X16	DFBR3616E	8,745.00	1255
36X18	DFBR3618E	11,270.00	1295
36X20	DFBR3620E	11,672.00	1315
36X24	DFBR3624E	11,043.00	1520
36X30	DFBR3630E	12,816.00	1785
42X12	DFBR4212E	POA	1655
42X14	DFBR4214E	14,802.00	1675
42X16	DFBR4216E	12,616.00	1715
42X18	DFBR4218E	16,680.00	1755
42X20	DFBR4220E	16,503.00	1820
42X24	DFBR4224E	14,565.00	1980
42X30	DFBR4230E	17,249.00	2245
42X36	DFBR4236E	24,934.00	2600
48X12	DFBR4812E	15,998.00	2175
48X14	DFBR4814E	19,150.00	2195
48X16	DFBR4816E	16,440.00	2235
48X18	DFBR4818E	23,160.00	2275
48X20	DFBR4820E	25,026.00	2340
48X24	DFBR4824E	23,830.00	2500
48X30	DFBR4830E	26,047.00	2765
48X36	DFBR4836E	26,204.00	3115
48X42	DFBR4842E	34,457.00	3580
54X12	DFBR5412E	POA	1990
54X14	DFBR5414E	POA	2015
54X16	DFBR5416E	POA	2055
54X18	DFBR5418E	POA	2095
54X20	DFBR5420E	POA	2160
54X24	DFBR5424E	POA	2320
54X30	DFBR5430E	POA	2585
54X36	DFBR5436E	POA	2940
54X42	DFBR5442E	POA	3395
54X48	DFBR5448E	POA	3565

CALL FOR BARE/BARE FITTINGS

**90° BASE BENDS**

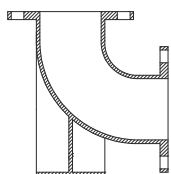

Size (in)	Item No.	List Price (\$)	Wt. (lb.)
3	DFBB9003E	218.00	35
4	DFBB9004E	343.00	55
6	DFBB9006E	503.00	85
8	DFBB9008E	950.00	145
10	DFBB9010E	1,302.00	210
12	DFBB9012E	1,855.00	300
14	DFBB9014E	2,229.00	320
16	DFBB9016E	2,756.00	445
18	DFBB9018E	3,499.00	565
20	DFBB9020E	4,604.00	700
24	DFBB9024E	6,775.00	1030
30	DFBB9030E	11,320.00	1625
36	DFBB9036E	16,614.00	2385
42	DFBB9042E	30,753.00	3465
48	DFBB9048E	33,906.00	4610
54	DFBB9054E	POA	4415

**90° LONG RADIUS BASE BENDS**

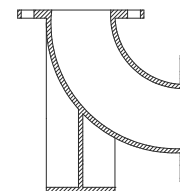

Size (in)	Item No.	List Price (\$)	Wt. (lb.)
3	DFBBLR9003E	238.00	40
4	DFBBLR9004E	373.00	60
6	DFBBLR9006E	619.00	100
8	DFBBLR9008E	1,116.00	180
10	DFBBLR9010E	1,627.00	260
12	DFBBLR9012E	2,552.00	390
14	DFBBLR9014E	2,583.00	650
16	DFBBLR9016E	4,579.00	815
18	DFBBLR9018E	4,950.00	955
20	DFBBLR9020E	6,479.00	1200
24	DFBBLR9024E	9,404.00	1770
30	DFBBLR9030E	16,716.00	2295
36	DFBBLR9036E	25,632.00	3535
42	DFBBLR9042E	40,563.00	5275
48	DFBBLR9048E	56,153.00	7305
54	DFBBLR9054E	POA	6880

**BASE TEES**

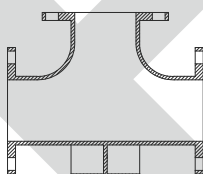

Size (in)	Item No.	List Price (\$)	Wt. (lb.)
3	DFTB0303E	283.00	45
4	DFTB0404E	467.00	75
6	DFTB0606E	683.00	110
8	DFTB0808E	1,149.00	185
10	DFTB1010E	1,858.00	300
12	DFTB1212E	2,662.00	430
14	DFTB1414E	3,004.00	500
16	DFTB1616E	3,713.00	600
18	DFTB1818E	4,579.00	740
20	DFTB2020E	6,116.00	930
24	DFTB2424E	9,274.00	1410
30	DFTB3030E	15,813.00	2270
36	DFTB3636E	23,124.00	3320
42	DFTB4242E	43,024.00	5850
48	DFTB4848E	56,777.00	7720
54	DFTB5454E	POA	6465

CALL FOR BARE/BARE FITTINGS

**90° REDUCING BASE BENDS**

(WITH BASE UNDER SMALL END)

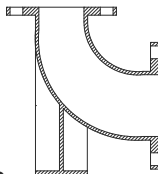

R - Available multiple size reductions.

Size (in)	Item No.	List Price (\$)	Wt. (lb.)
4 X 3	DFBBSDR0403E	POA	45
6 X 4	DFBBSDR0604E	POA	75
8 X 4	DFBBSDR0804E	POA	120
8 X 6	DFBBSDR0806E	POA	130
10X 6	DFBBSDR1006E	POA	170
10X 8	DFBBSDR1008E	POA	195
12X 6	DFBBSDR1206E	POA	230
12X 8	DFBBSDR1208E	POA	255
12X10	DFBBSDR1210E	POA	285
14X R	DFBBSDR14E	POA	
16X R	DFBBSDR16E	POA	
18X R	DFBBSDR18E	POA	
20X R	DFBBSDR20E	POA	
24X R	DFBBSDR24E	POA	
30X R	DFBBSDR30E	POA	
36X R	DFBBSDR36E	POA	
42X R	DFBBSDR42E	POA	
48X R	DFBBSDR48E	POA	
54X R	DFBBSDR54E	POA	

**90° REDUCING BASE BENDS**

(WITH BASE UNDER LARGE END)

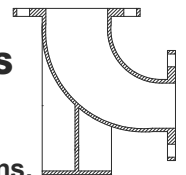

R - Available multiple size reductions.

Size (in)	Item No.	List Price (\$)	Wt. (lb.)
4 X 3	DFBBLDR0403E	POA	45
6 X 4	DFBBLDR0604E	POA	75
8 X 4	DFBBLDR0804E	POA	120
8 X 6	DFBBLDR0806E	POA	130
10X 6	DFBBLDR1006E	POA	170
10X 8	DFBBLDR1008E	POA	195
12X 6	DFBBLDR1206E	POA	230
12X 8	DFBBLDR1208E	POA	255
12X10	DFBBLDR1210E	POA	285
14X R	DFBBLDR14E	POA	
16X R	DFBBLDR16E	POA	
18X R	DFBBLDR18E	POA	
20X R	DFBBLDR20E	POA	
24X R	DFBBLDR24E	POA	
30X R	DFBBLDR30E	POA	
36X R	DFBBLDR36E	POA	
42X R	DFBBLDR42E	POA	
48X R	DFBBLDR48E	POA	
54X R	DFBBLDR54E	POA	

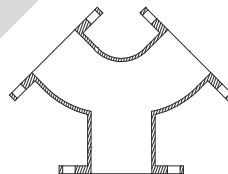
**TRUE WYES**

Size (in)	Item No.	List Price (\$)	Wt. (lb.)
4 X 4 X 4	DFYT0404E	312.00	50
6 X 4 X 4	DFYT060404E	POA	75
6 X 6 X 6	DFYT0606E	497.00	80
8 X 6 X 6	DFYT080606E	POA	120
8 X 8 X 4	DFYT080804E	532.00	
8 X 8 X 8	DFYT0808E	868.00	125
10 X 10 X 6	DFYT101006E	868.00	
10 X 8 X 8	DFYT100808E	962.00	155
10 X 10 X 10	DFYT101010E	1,149.00	185
12 X 12 X 6	DFYT121206E	992.00	
12 X 12 X 8	DFYT121208E	1,302.00	

Size (in)	Item No.	List Price (\$)	Wt. (lb.)
12 X 12 X 10	DFYT121210E	1,487.00	
12 X 12 X 12	DFYT1212E	1,858.00	300
14 X 14 X 14	DFYT1414E	2,570.00	415
16 X 16 X 16	DFYT1616E	3,592.00	580
18 X 18 X 18	DFYT1818E	4,208.00	680
20 X 20 X 20	DFYT2020E	6,314.00	960
24 X 24 X 24	DFYT2424E	9,010.00	1370
30 X 30 X 30	DFYT3030E	POA	80
36 X 36 X 36	DFYT3636E	POA	120
42 X 42 X 42	DFYT4242E	POA	125
48 X 48 X 48	DFYT4848E	POA	120

CALL FOR BARE/BARE FITTINGS



**FLANGE TEES**

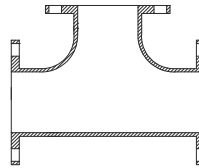

Size (in)	Item No.	List Price (\$)	Wt. (lb.)
2 X 2	DFT0202E	150.00	20
3 X 2	DFT0302E	218.00	35
3 X 3	DFT0303E	215.00	40
4 X 2	DFT0402E	312.00	50
4 X 3	DFT0403E	373.00	60
4 X 4	DFT0404E	407.00	65
5 X 5	DFT0505E	POA	80
6 X 2	DFT0602E	532.00	156
6 X 3	DFT0603E	532.00	85
6 X 4	DFT0604E	559.00	90
6 X 6	DFT0606E	533.00	95
8 X 3	DFT0803E	857.00	130
8 X 4	DFT0804E	824.00	140
8 X 6	DFT0806E	766.00	145
8 X 8	DFT0808E	886.00	155
10X 4	DFT1004E	1,152.00	205
10X 6	DFT1006E	1,099.00	215
10X 8	DFT1008E	1,155.00	225
10X10	DFT1010E	1,342.00	270
12X 4	DFT1204E	1,575.00	290
12X 6	DFT1206E	1,532.00	295
12X 8	DFT1208E	1,614.00	310
12X10	DFT1210E	1,903.00	360
12X12	DFT1212E	1,943.00	385
14X 4	DFT1404E	POA	370
14X 6	DFT1406E	2,323.00	375
14X 8	DFT1408E	2,415.00	390
14X10	DFT1410E	2,476.00	400
14X12	DFT1412E	2,632.00	425
14X14	DFT1414E	2,694.00	435
16X 4	DFT1604E	POA	460
16X 6	DFT1606E	2,709.00	465
16X 8	DFT1608E	2,649.00	475
16X10	DFT1610E	3,046.00	495
16X12	DFT1612E	2,942.00	520
16X14	DFT1614E	3,282.00	530
16X16	DFT1616E	3,036.00	550
18X 6	DFT1806E	2,676.00	480
18X 8	DFT1808E	3,219.00	495
18X10	DFT1810E	3,157.00	510

Size (in)	Item No.	List Price (\$)	Wt. (lb.)
18X12	DFT1812E	3,443.00	535
18X14	DFT1814E	3,837.00	630
18X16	DFT1816E	4,023.00	650
18X18	DFT1818E	3,752.00	785
20X 6	DFT2006E	4,014.00	610
20X 8	DFT2008E	4,079.00	620
20X10	DFT2010E	4,178.00	635
20X12	DFT2012E	4,342.00	660
20X14	DFT2014E	4,375.00	665
20X16	DFT2016E	5,328.00	810
20X18	DFT2018E	5,395.00	820
20X20	DFT2020E	4,747.00	855
24X 4	DFT2404E	5,560.00	
24X 6	DFT2406E	4,802.00	845
24X 8	DFT2408E	5,658.00	860
24X10	DFT2410E	5,789.00	880
24X12	DFT2412E	5,026.00	890
24X14	DFT2414E	5,876.00	900
24X16	DFT2416E	5,150.00	915
24X18	DFT2418E	8,024.00	1220
24X20	DFT2420E	8,255.00	1510
24X24	DFT2424E	7,514.00	1330
30X 6	DFT3006E	10,138.00	1450
30X 8	DFT3008E	10,170.00	
30X10	DFT3010E	10,380.00	
30X12	DFT3012E	10,380.00	1490
30X14	DFT3014E	10,380.00	1490
30X16	DFT3016E	10,485.00	1505
30X18	DFT3018E	10,555.00	1515
30X20	DFT3020E	10,727.00	1540
30X24	DFT3024E	14,107.00	2025
30X30	DFT3030E	13,077.00	2150
36X10	DFT3610E	15,013.00	3082
36X12	DFT3612E	15,117.00	2170
36X14	DFT3614E	15,152.00	2175
36X16	DFT3616E	15,222.00	2185
36X18	DFT3618E	15,255.00	2190
36X20	DFT3620E	15,395.00	2210
36X24	DFT3624E	15,709.00	2255

Contd.....

CALL FOR BARE/BARE FITTINGS

**FLANGE TEES**

Contd.....

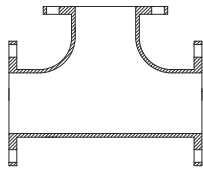
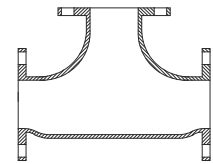
**FLANGE TEES -  
BULL HEAD**

Size (in)	Item No.	List Price (\$)	Wt. (lb.)
36X30	DFT3630E	20,895.00	3000
36X36	DFT3636E	19,430.00	3160
42X12	DFT4212E	23,279.00	3165
42X14	DFT4214E	23,316.00	3170
42X16	DFT4216E	23,389.00	3180
42X18	DFT4218E	23,425.00	3185
42X20	DFT4220E	23,575.00	3205
42X24	DFT4224E	23,868.00	3245
42X30	DFT4230E	30,339.00	4125
42X36	DFT4236E	39,422.00	5360
42X42	DFT4242E	41,040.00	5580
48X12	DFT4812E	31,738.00	4315
48X14	DFT4814E	31,738.00	4315
48X16	DFT4816E	31,846.00	4330
48X18	DFT4818E	31,846.00	4330
48X20	DFT4820E	31,993.00	4350
48X24	DFT4824E	32,250.00	4385
48X30	DFT4830E	32,767.00	4455
48X36	DFT4836E	40,856.00	7035
48X42	DFT4842E	52,917.00	7195
48X48	DFT4848E	54,315.00	7385
54X12	DFT5412E	POA	4435
54X14	DFT5414E	POA	4435
54X16	DFT5416E	POA	4450
54X18	DFT5418E	POA	4460
54X20	DFT5420E	POA	4480
54X24	DFT5424E	POA	4515
54X30	DFT5430E	POA	4615
54X36	DFT5436E	POA	4695
54X42	DFT5442E	POA	5740
54X48	DFT5448E	POA	5850
54X54	DFT5454E	POA	6025

Size (in)	Item No.	List Price (\$)	Wt. (lb.)
4 X 4 X 6	DFTBH040406E	754.00	90
6 X 6 X 8	DFTBH060608E	876.00	140
8 X 8 X 10	DFTBH080810E	1,610.00	260
8 X 8 X 12	DFTBH080812E	1,633.00	291
10X10X12	DFTBH101012E	2,282.00	355

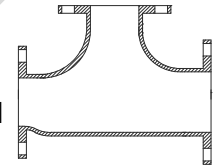
**FLANGE TEES -  
REDUCING ON THE RUN**

Size (in)	Item No.	List Price (\$)	Wt. (lb.)
4 X 3 X 3	DFTROR040303E	POA	55
6 X 4 X 4	DFTROR060404E	559.00	103
6 X 4 X 6	DFTROR060406E	559.00	108
8 X 6 X 4	DFTROR080604E	777.00	146
8 X 6 X 6	DFTROR080606E	900.00	148
8 X 6 X 8	DFTROR080608E	992.00	145
10X 6 X 6	DFTROR100606E	1,804.00	275
10X 6 X 10	DFTROR100610E	1,776.00	305
10X 8 X 6	DFTROR100806E	1,815.00	280
10X 8 X 8	DFTROR100808E	1,916.00	302
10X 8 X 10	DFTROR100810E	1,965.00	325
12X 6 X 6	DFTROR120606E	2,244.00	340
12X 6 X 8	DFTROR120608E	2,348.00	360
12X 8 X 6	DFTROR120806E	2,302.00	355
12X 8 X 8	DFTROR120808E	2,432.00	375
12X 8 X 12	DFTROR120812E	2,723.00	420
12X10X 6	DFTROR121006E	2,248.00	390
12X10X 8	DFTROR121008E	2,593.00	400
12X10X10	DFTROR121010E	2,723.00	420
12X10X12	DFTROR121012E	2,852.00	440

CALL FOR BARE/BARE FITTINGS

**FLANGE CROSS**

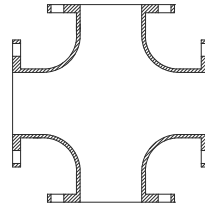

Size (in)	Item No.	List Price (\$)	Wt. (lb.)
3 X 3	DFX0303E	312.00	50
4 X 3	DFX0403E	436.00	70
4 X 4	DFX0404E	449.00	80
6 X 3	DFX0603E	590.00	95
6 X 4	DFX0604E	683.00	110
6 X 6	DFX0606E	726.00	120
8 X 3	DFX0803E	POA	140
8 X 4	DFX0804E	962.00	155
8 X 6	DFX0806E	1,025.00	175
8 X 8	DFX0808E	1,087.00	195
10X 4	DFX1004E	1,363.00	220
10X 6	DFX1006E	1,487.00	240
10X 8	DFX1008E	1,643.00	265
10X10	DFX1010E	2,045.00	330
12X 4	DFX1204E	1,920.00	310
12X 6	DFX1206E	1,980.00	320
12X 8	DFX1208E	2,138.00	345
12X10	DFX1210E	2,570.00	415
12X12	DFX1212E	2,410.00	460
14X 6	DFX1406E	2,476.00	400
14X 8	DFX1408E	2,632.00	425
14X10	DFX1410E	2,848.00	460
14X12	DFX1412E	3,128.00	505
14X14	DFX1414E	3,282.00	530
16X 6	DFX1606E	3,034.00	490
16X 8	DFX1608E	3,219.00	520
16X10	DFX1610E	3,436.00	555
16X12	DFX1612E	3,747.00	605
16X14	DFX1614E	POA	620
16X16	DFX1616E	4,117.00	755
18X 6	DFX1806E	3,128.00	505
18X 8	DFX1808E	3,312.00	535
18X10	DFX1810E	3,467.00	560
18X12	DFX1812E	3,775.00	610
18X14	DFX1814E	4,455.00	720
18X16	DFX1816E	4,736.00	765
18X18	DFX1818E	4,922.00	795
20X 6	DFX2006E	4,178.00	635
20X 8	DFX2008E	4,375.00	665

Size (in)	Item No.	List Price (\$)	Wt. (lb.)
20X10	DFX2010E	4,507.00	685
20X12	DFX2012E	4,836.00	735
20X14	DFX2014E	4,902.00	745
20X16	DFX2016E	6,019.00	915
20X18	DFX2018E	6,216.00	945
20X20	DFX2020E	6,677.00	1015
24X 6	DFX2406E	5,758.00	875
24X 8	DFX2408E	5,887.00	895
24X10	DFX2410E	6,116.00	930
24X12	DFX2412E	6,314.00	960
24X14	DFX2414E	6,414.00	975
24X16	DFX2416E	6,644.00	1010
24X18	DFX2418E	8,979.00	1365
24X20	DFX2420E	9,404.00	1430
24X24	DFX2424E	10,326.00	1570
30X10	DFX3010E	POA	
30X12	DFX3012E	10,904.00	1565
30X14	DFX3014E	10,938.00	1570
30X16	DFX3016E	11,183.00	1605
30X18	DFX3018E	11,250.00	1515
30X20	DFX3020E	11,634.00	1670
30X24	DFX3024E	15,640.00	2245
30X30	DFX3030E	17,414.00	2500
36X12	DFX3612E	15,603.00	2240
36X14	DFX3614E	15,603.00	2240
36X16	DFX3616E	15,813.00	2270
36X18	DFX3618E	15,882.00	2280
36X20	DFX3620E	16,196.00	2325
36X24	DFX3624E	16,754.00	2405
36X30	DFX3630E	22,985.00	3300
36X36	DFX3636E	25,214.00	3620
42X12	DFX4212E	23,830.00	3240
42X14	DFX4214E	23,830.00	3240
42X16	DFX4216E	24,052.00	3270
42X18	DFX4218E	24,088.00	3275
42X20	DFX4220E	24,419.00	3320
42X24	DFX4224E	24,972.00	4135
42X30	DFX4230E	32,177.00	4375
42X36	DFX4236E	42,068.00	5720

Contd.....

CALL FOR BARE/BARE FITTINGS

**FLANGE CROSS**

Contd.....

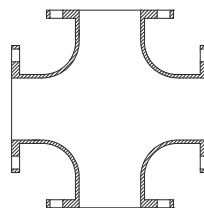

Size (in)	Item No.	List Price (\$)	Wt. (lb.)
42X42	DFX4242E	45,270.00	6155
48X12	DFX4812E	32,288.00	4390
48X14	DFX4814E	32,250.00	4385
48X16	DFX4816E	32,473.00	4415
48X18	DFX4818E	32,508.00	4420
48X20	DFX4820E	32,802.00	4460
48X24	DFX4824E	33,355.00	4535
48X30	DFX4830E	34,346.00	5705
48X36	DFX4836E	43,245.00	7310
48X42	DFX4842E	56,116.00	7630
48X48	DFX4848E	58,875.00	8005

Size (in)	Item No.	List Price (\$)	Wt. (lb.)
54X12	DFX5412E	POA	4575
54X14	DFX5414E	POA	4575
54X16	DFX5416E	POA	4605
54X18	DFX5418E	POA	4625
54X20	DFX5420E	POA	4665
54X24	DFX5424E	POA	4700
54X30	DFX5430E	POA	4800
54X36	DFX5436E	POA	4950
54X42	DFX5442E	POA	6210
54X48	DFX5448E	POA	6425
54X54	DFX5454E	POA	6780

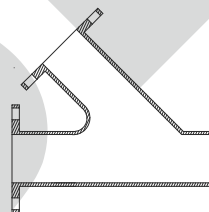
**FLANGE LATERAL WYES**

Size (in)	Item No.	List Price (\$)	Wt. (lb.)
3 X 3	DFY0303E	283.00	45
4 X 2	DFY0402E	343.00	
4 X 3	DFY0403E	407.00	65
4 X 4	DFY0404E	396.00	75
6 X 3	DFY0603E	619.00	
6 X 4	DFY0604E	714.00	105
6 X 6	DFY0606E	633.00	120
8 X 4	DFY0804E	1,116.00	165
8 X 6	DFY0806E	1,078.00	175
8 X 8	DFY0808E	1,037.00	200
10X 4	DFY1004E	1,610.00	240
10X 6	DFY1006E	1,674.00	250
10X 8	DFY1008E	1,829.00	335
10X10	DFY1010E	1,657.00	335
12X 4	DFY1204E	2,353.00	350
12X 6	DFY1206E	2,447.00	427
12X 8	DFY1208E	2,415.00	452

Size (in)	Item No.	List Price (\$)	Wt. (lb.)
12X10	DFY1210E	2,818.00	420
12X12	DFY1212E	2,526.00	515
14X 6	DFY1406E	3,219.00	475
14X 8	DFY1408E	3,375.00	500
14X10	DFY1410E	3,252.00	525
14X12	DFY1412E	3,837.00	570
14X14	DFY1414E	3,747.00	605
16X 6	DFY1606E	3,837.00	620
16X 8	DFY1608E	4,394.00	645
16X10	DFY1610E	4,579.00	675
16X12	DFY1612E	4,425.00	715
16X14	DFY1614E	5,137.00	755
16X16	DFY1616E	4,985.00	805
18X 6	DFY1806E	2,786.00	
18X 8	DFY1808E	3,870.00	780
18X10	DFY1810E	5,478.00	810
18X12	DFY1812E	5,755.00	850

Contd.....

CALL FOR BARE/BARE FITTINGS

**FLANGE LATERAL WYES**

Contd.....

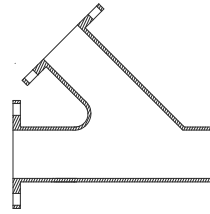

Size (in)	Item No.	List Price (\$)	Wt. (lb.)
18X14	DFY1814E	6,035.00	885
18X16	DFY1816E	6,344.00	935
18X18	DFY1818E	6,064.00	1035
20X 8	DFY2008E	4,867.00	740
20X10	DFY2010E	5,297.00	1025
20X12	DFY2012E	7,303.00	1065
20X14	DFY2014E	7,993.00	1110
20X16	DFY2016E	8,353.00	1155
20X18	DFY2018E	7,892.00	1200
20X20	DFY2020E	8,322.00	1265
24X 6	DFY2406E	6,973.00	
24X 8	DFY2408E	7,103.00	1425
24X10	DFY2410E	9,899.00	1460
24X12	DFY2412E	7,892.00	1550
24X14	DFY2414E	11,508.00	1560
24X16	DFY2416E	12,428.00	1615
24X18	DFY2418E	12,202.00	1680
24X20	DFY2420E	11,508.00	1750
24X24	DFY2424E	12,529.00	1905
30X12	DFY3012E	19,470.00	2545
30X14	DFY3014E	19,854.00	2590
30X16	DFY3016E	20,236.00	2645
30X18	DFY3018E	20,618.00	2690
30X20	DFY3020E	21,174.00	2760
30X24	DFY3024E	22,325.00	2915
30X30	DFY3030E	22,465.00	3225
36X12	DFY3612E	31,275.00	4490
36X14	DFY3614E	31,658.00	4545
36X16	DFY3616E	31,033.00	4000
36X18	DFY3618E	32,528.00	4670

Size (in)	Item No.	List Price (\$)	Wt. (lb.)
36X20	DFY3620E	31,867.00	4750
36X24	DFY3624E	32,912.00	4920
36X30	DFY3630E	36,218.00	5255
36X36	DFY3636E	39,978.00	5740
42X12	DFY4212E	42,106.00	5725
42X14	DFY4214E	42,657.00	5800
42X16	DFY4216E	43,024.00	5850
42X18	DFY4218E	44,128.00	6000
42X20	DFY4220E	44,938.00	6680
42X24	DFY4224E	46,005.00	6850
42X30	DFY4230E	50,418.00	7185
42X36	DFY4236E	56,264.00	7670
42X42	DFY4242E	67,442.00	9185
48X12	DFY4812E	52,954.00	7200
48X14	DFY4814E	53,506.00	7276
48X16	DFY4816E	54,424.00	7400
48X18	DFY4818E	56,042.00	7620
48X20	DFY4820E	56,520.00	7685
48X24	DFY4824E	50,306.00	8695
48X30	DFY4830E	58,948.00	5573
48X36	DFY4836E	65,970.00	9515
48X42	DFY4842E	80,974.00	11030
48X48	DFY4848E	88,988.00	12115
54X24	DFY5424E	POA	6220
54X30	DFY5430E	POA	7478
54X36	DFY5436E	POA	7600
54X42	DFY5442E	POA	8930
54X48	DFY5448E	POA	9480
54X54	DFY5454E	POA	11780
60X30	DFY6030E	POA	9045

CALL FOR BARE/BARE FITTINGS

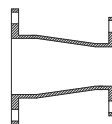

**CONCENTRIC REDUCER**

Size (in)	Item No.	List Price (\$)	Wt. (lb.)
3 X 2	DFCR0302E	103.00	16
4 X 2	DFCR0402E	159.00	25
4 X 2.5	DFCR0402.5E	POA	26
4 X 3	DFCR0403E	160.00	30
6 X 2	DFCR0602E	218.00	35
6 X 3	DFCR0603E	248.00	40
6 X 4	DFCR0604E	249.00	45
6 X 5	DFCR0605E	317.00	52
8 X 3	DFCR0803E	POA	60
8 X 4	DFCR0804E	374.00	65
8 X 5	DFCR0805E	436.00	70
8 X 6	DFCR0806E	408.00	75
10X 4	DFCR1004E	532.00	85
10X 6	DFCR1006E	529.00	90
10X 8	DFCR1008E	662.00	110
12X 4	DFCR1204E	744.00	120
12X 6	DFCR1206E	780.00	130
12X 8	DFCR1208E	872.00	145
12X10	DFCR1210E	988.00	170
14X 6	DFCR1406E	962.00	155
14X 8	DFCR1408E	1,086.00	175
14X10	DFCR1410E	1,195.00	190
14X12	DFCR1412E	1,167.00	248
16X 6	DFCR1606E	1,179.00	190
16X 8	DFCR1608E	1,114.00	210
16X10	DFCR1610E	1,253.00	235
16X12	DFCR1612E	1,607.00	265
16X14	DFCR1614E	1,735.00	280
18X 8	DFCR1808E	1,487.00	240
18X10	DFCR1810E	1,643.00	265
18X12	DFCR1812E	1,646.00	295
18X14	DFCR1814E	1,920.00	310
18X16	DFCR1816E	1,904.00	340
20X 6	DFCR2006E	1,975.00	

Size (in)	Item No.	List Price (\$)	Wt. (lb.)
20X 8	DFCR2008E	1,877.00	
20X10	DFCR2010E	2,042.00	310
20X12	DFCR2012E	2,027.00	345
20X14	DFCR2014E	2,339.00	355
20X16	DFCR2016E	2,175.00	390
20X18	DFCR2018E	2,700.00	410
24X 8	DFCR2408E	2,698.00	410
24X10	DFCR2410E	3,093.00	
24X12	DFCR2412E	3,359.00	480
24X14	DFCR2414E	3,449.00	490
24X16	DFCR2416E	3,007.00	525
24X18	DFCR2418E	3,618.00	550
24X20	DFCR2420E	3,882.00	590
30X12	DFCR3012E	5,366.00	825
30X16	DFCR3016E	5,434.00	770
30X18	DFCR3018E	5,645.00	810
30X20	DFCR3020E	6,063.00	870
30X24	DFCR3024E	6,759.00	970
36X16	DFCR3616E	7,699.00	1105
36X18	DFCR3618E	8,082.00	
36X20	DFCR3620E	8,569.00	1230
36X24	DFCR3624E	9,372.00	1345
36X30	DFCR3630E	10,834.00	1555
42X24	DFCR4224E	13,387.00	1820
42X30	DFCR4230E	15,150.00	2060
42X36	DFCR4236E	17,249.00	2550
48X30	DFCR4830E	19,307.00	2625
48X36	DFCR4836E	21,698.00	2950
48X42	DFCR4842E	24,419.00	3320
54X30	DFCR5430E	POA	1625
54X36	DFCR5436E	POA	1680
54X42	DFCR5442E	POA	1800
54X48	DFCR5448E	POA	1695

CALL FOR BARE/BARE FITTINGS

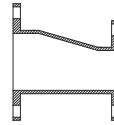

**ECCENTRIC REDUCER**

Size (in)	Item No.	List Price (\$)	Wt. (lb.)
3 X 2	DFER0302E	103.00	16
4 X 2	DFER0402E	159.00	25
4 X 3	DFER0403E	189.00	30
6 X 2	DFER0602E	POA	35
6 X 3	DFER0603E	248.00	40
6 X 4	DFER0604E	283.00	45
6 X 5	DFER0605E	325.00	52
8 X 3	DFER0803E	POA	60
8 X 4	DFER0804E	407.00	65
8 X 5	DFER0805E	436.00	70
8 X 6	DFER0806E	467.00	75
10X 4	DFER1004E	532.00	85
10X 6	DFER1006E	559.00	90
10X 8	DFER1008E	683.00	110
12X 4	DFER1204E	744.00	120
12X 6	DFER1206E	807.00	130
12X 8	DFER1208E	900.00	145
12X10	DFER1210E	1,055.00	170
14X 6	DFER1406E	962.00	155
14X 8	DFER1408E	1,055.00	175
14X10	DFER1410E	1,179.00	190
14X12	DFER1412E	1,395.00	248
16X 6	DFER1606E	1,179.00	190
16X 8	DFER1608E	1,302.00	210
16X10	DFER1610E	1,457.00	235
16X12	DFER1612E	1,643.00	265
16X14	DFER1614E	1,735.00	280
18X 8	DFER1808E	1,487.00	240
18X10	DFER1810E	1,643.00	265
18X12	DFER1812E	1,829.00	295
18X14	DFER1814E	1,920.00	310
18X16	DFER1816E	2,105.00	340
20X 8	DFER2008E	1,908.00	
20X10	DFER2010E	2,042.00	310

Size (in)	Item No.	List Price (\$)	Wt. (lb.)
20X12	DFER2012E	2,272.00	345
20X14	DFER2014E	2,339.00	355
20X16	DFER2016E	2,566.00	390
20X18	DFER2018E	2,698.00	410
24X 8	DFER2408E	3,027.00	
24X10	DFER2410E	3,093.00	
24X12	DFER2412E	3,158.00	480
24X14	DFER2414E	3,224.00	490
24X16	DFER2416E	3,456.00	525
24X18	DFER2418E	3,618.00	550
24X20	DFER2420E	3,882.00	590
30X10	DFER3010E	5,268.00	
30X14	DFER3014E	6,759.00	825
30X16	DFER3016E	6,516.00	770
30X18	DFER3018E	5,679.00	810
30X20	DFER3020E	6,063.00	870
30X24	DFER3024E	6,759.00	970
36X14	DFER3614E	8,987.00	1290
36X16	DFER3616E	7,769.00	1105
36X18	DFER3618E	8,082.00	
36X20	DFER3620E	8,535.00	1230
36X24	DFER3624E	9,334.00	1345
36X30	DFER3630E	10,799.00	1555
42X24	DFER4224E	13,387.00	1820
42X30	DFER4230E	15,150.00	2060
42X36	DFER4236E	17,249.00	2550
48X30	DFER4830E	19,307.00	2625
48X36	DFER4836E	21,698.00	2950
48X42	DFER4842E	24,419.00	3320
54X30	DFER5430E	POA	1625
54X36	DFER5436E	POA	1680
54X42	DFER5442E	POA	1800
54X48	DFER5448E	POA	1695

**CALL FOR BARE/BARE FITTINGS**

**BLIND FLANGES**

Size (in)	Item No.	List Price (\$)	Wt. (lb.)
2	DBF02E	POA	9
3	DBF03E	60.00	9
4	DBF04E	104.00	16
6	DBF06E	158.00	25
8	DBF08E	263.00	42
10	DBF10E	393.00	63
12	DBF12E	529.00	85
14	DBF14E	743.00	120
16	DBF16E	900.00	145
18	DBF18E	1,207.00	195
20	DBF20E	1,610.00	245
24	DBF24E	2,395.00	370
30	DBF30E	3,480.00	500
36	DBF36E	6,676.00	960
42	DBF42E	9,545.00	1300
48	DBF48E	12,773.00	1740
54	DBF54E	POA	2600

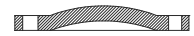
**2" TAPPED  
BLIND FLANGES**

Size (in)	Item No.	List Price (\$)	Wt. (lb.)
3	DBFT03E	99.00	9
4	DBFT04E	142.00	16
6	DBFT06E	196.00	25
8	DBFT08E	300.00	42
10	DBFT10E	432.00	63
12	DBFT12E	568.00	85
14	DBFT14E	805.00	120
16	DBFT16E	964.00	145
18	DBFT18E	1,285.00	195
20	DBFT20E	1,688.00	245
24	DBFT24E	2,474.00	370
30	DBFT30E	3,596.00	500
36	DBFT36E	6,793.00	960
42	DBFT42E	9,700.00	1300
48	DBFT48E	12,929.00	1740
54	DBFT54E	POA	2600

CALL FOR BARE/BARE FITTINGS

										NOTES



# SIP Industries

Quality Manufacturers Since 1960

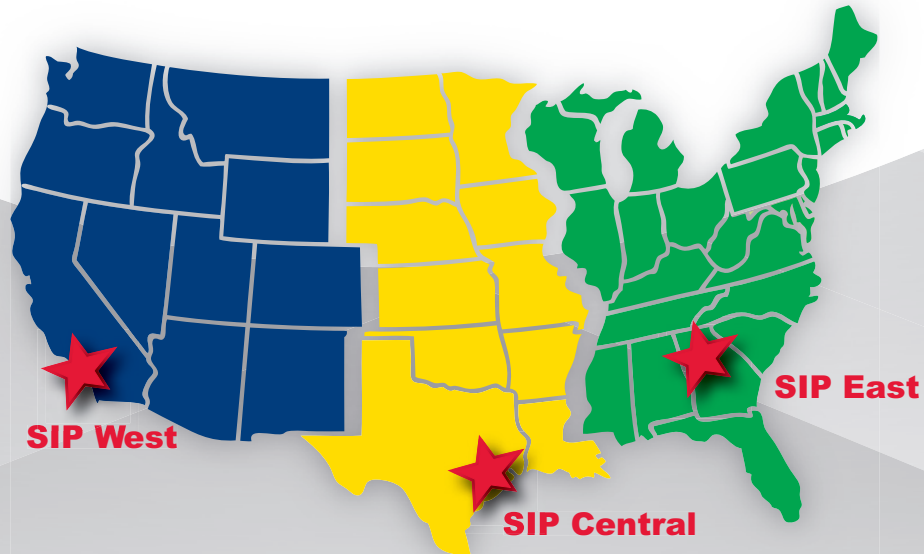

## PRODUCT LINE

### AWWA DI Fittings & Accessories

- C153 Compact MJ Fittings and Acc. 2" - 64"
- C110 Full Body MJ Fittings 2" - 64"
- C153 Trim Tyton® Push-On Fittings 4" - 24"
- C110 Flange Fittings 2" - 64"
- MJ x MJ Adapter for Connecting MJ Bells 3" - 24"
- Stainless Steel & Blue T-Bolts
- Made in India, China & Mexico
- Bare, Cement, Zinc, FBE & Other Linings

### Joint Restraint System

- EZD Joint Restraint for DI Pipe 3" - 48"
- EZDTP Joint Restraint Tandem for DI Pipe 3" - 48"
- EZDPTP Joint Restraint for Push-On Joints DI Pipe 3" - 48"
- Ductile Iron Retainer Glands 3" - 30"
- FAR / FAH Flange Adapter for DI Pipe 3" - 48"
- EZFA Restrained Flange Adapter for DI and PVC Pipe 3" - 36"
- EZPVC Joint Restraint for PVC Pipe 3" - 36"
- ULTRA Joint Restraint for PVC Pipe 4" - 12"
- EZPVCPTP Joint Restraint for Push-On Joints PVC Pipe 14" - 36"
- PTPVC Pipe to Pipe Restraint 4" - 48"
- PTPDF Pipe to MJ Fittings Restraint 4" - 48"
- PTPFC Pipe to PVC Fittings Restraint 4" - 12"
- Made in China & USA
- EZ Shield or Shop Coating

### Municipal Construction Castings

- Manhole Rings and Cover
- Frames and Grates
- Valve Boxes and Service Boxes
- Water Meter Covers and Boxes
- Cleanout and Monument Boxes
- Detectable Warning Plates
- Extension Rings
- Trench Grates and Tree Grates
- Made in India & USA

### Fabrication Products for DI Pipe

- High Hub Flanges Class 150 and 250. 3" - 64"
- Threaded Bell Flanges 3" - 48"
- Anchor Flanges 3" - 60"
- Filler Flanges 4" - 30"

### Other Products and Services

- All Thread Rod
- Pipe Lube and Hydraulic Cement
- Socket Clamps and Lugs
- Flange Packs
- OEM Castings



**SIP CORPORATE** 8876 Gulf Freeway, Suite 500, Houston, TX 77017

**SIP CENTRAL** 2900 Patio Drive, Houston, TX 77017

**SIP EAST** 600 Rayloc Drive, Atlanta, GA 30336

**SIP WEST** 8333 Almeria Avenue, Fontana, CA 92335

Phone: 877-921-6111 or 713-923-6111 | Fax: 713-923-6114 | [www.sipindustries.com](http://www.sipindustries.com) | [sales@sipindustries.com](mailto:sales@sipindustries.com)