



SIP Industries



Quality Manufacturers Since 1960

Utility Pipe Fittings P401 Lined

PRICE LIST

Effective : January 14, 2019

www.sipindustries.com

Toll Free 877-921-6111



										NOTES

TABLE OF CONTENTS

GENERAL TERMS & CONDITIONS.....	Page : P002 - P004
P401 LINED-COMPACT MJ FITTINGS ANSI/AWWA C153/A21.53.....	Page : P005 - P018
P401 LINED-FULL BODY MJ FITTINGS ANSI/AWWA C110/A21.10.....	Page : P019 - P032
P401 LINED-FLANGE FITTINGS ANSI/AWWA C110/A21.10.....	Page : P033 - P046

- All dimensions are in inches unless noted otherwise.
- All weights are approximate in pounds unless noted otherwise.
- POA = Price on availability.
- R = Available multiple size reductions.

SIP INDUSTRIES

GENERAL TERMS AND CONDITIONS OF SALE

1. Acceptance. All sales by SIP Industries (Seller) are made pursuant to these Terms and Conditions. Submission of a purchase order to Seller, and/or acceptance of goods delivered by Seller, shall be deemed an acceptance of these Terms and Conditions by Purchaser. Please note that these Terms and Conditions may be modified from time to time; the applicable Terms and Conditions are those posted on SIP's website, www.sipindustries.com, at the time that a purchase order is accepted or an agreement otherwise confirmed. Purchaser's alteration or addition to these Terms and Conditions, as same may be in effect from time to time, is expressly rejected unless accepted in writing by an authorized representative of Seller.

2. Entire Agreement. These Terms and Conditions, together with Seller's price list and Purchaser's purchase order, when accepted by Seller, shall be the entire agreement between Seller and Purchaser. Neither Seller nor Purchaser is relying on any representations, warranties or agreements except as expressly provided in these Terms and Conditions and in an accepted purchase order. To the extent of any conflict between the terms of a purchase order or any other documents submitted by Purchaser, on the one hand, and these Terms and Conditions, on the other, these Terms and Conditions shall govern.

3. Prices. Prices and descriptions of goods stated in Seller's price lists are subject to change without notice. Prices are subject to tariffs, raw material surcharges, labor disputes and shipping surcharges. To submit a purchase order, SIP Industries item numbers and part codes should be included. Seller's quotations are on globally sourced products unless otherwise noted. The ordering party is responsible to specify any required origin as required for end use. Quotations, if provided by Seller, expire sixty (60) days from the date provided unless otherwise agreed in writing.

4. Terms. Invoices are due and payable thirty (30) days from date of shipment, unless otherwise written on the invoice or confirmed in writing by Seller. A five percent (5%) late fee will be charged on all past-due accounts. If it becomes necessary to retain attorneys to collect an account, the Purchaser is liable for Seller's attorney's fees and other costs of collection.

5. FOB point of shipment. All prices are FOB point of shipment, unless otherwise agreed in writing. Seller's responsibility for goods therefore ceases and title passes to the Purchaser at the point of shipment; all claims for damages or losses in transit must be directed to the carrier with copy to Seller within ten (10) days of shipment.

6. Delivery. Seller shall have the right to select the freight carrier unless otherwise agreed. Seller has the right to substitute material with same function and design to accommodate unforeseen delays, shortages or restrictions.

7. Cancellations, Changes and Returns. All cancellations, changes and returns must be accepted in writing by an authorized representative of Seller, otherwise they will not be valid and binding on Seller. Seller will not be responsible for unauthorized returned product. It will be the responsibility of purchaser at their expense to have unauthorized product returned or disposed of. Seller shall not be obligated to accept any cancellation, change or return, but if it does so the following terms shall apply: (i) goods must be returned to Seller's facility, in the same condition in which they were accepted by Purchaser; (ii) a handling charge of thirty-five percent (35%) of the purchase price will be deducted from the credit given to Purchaser; and (iii) shipping charges, if not prepaid by Purchaser, will likewise be deducted from the credit given to Purchaser.

8. Specially Manufactured Goods. Unless otherwise agreed, specially-manufactured goods, including goods designed to the Purchaser's specifications, may not be cancelled or returned once work has begun to design or manufacture the goods unless an agreement is reached and confirmed in writing by Seller, including compensation to Seller for work thus far done with respect to the goods.

9. Delays; Force Majeure. Seller shall not be liable for any expenses, loss or damage resulting from any delay in delivery of goods or other failure of Seller's performance due to fire, floods, acts of god, strikes, labor disputes, labor shortages, riots, accidents, transportation delays or other causes beyond the reasonable control of Seller.

10. Disclaimer regarding weights. All stated weights are approximate and are given for inventory and shipping purposes only.

11. Taxes. Seller's prices do not include sales, excise or other taxes. Purchaser shall pay all such taxes. If Purchaser claims a tax exemption, Purchaser shall provide Seller with the necessary tax-exemption numbers and certificates. If Seller accepts an exemption but is later required by the taxing authority to pay taxes, Purchaser shall reimburse to Seller the amount of such taxes.

12. Limited Warranty. For a period of one calendar year from the date of shipment, Seller warrants that goods sold and delivered by Seller to Purchaser will conform to the number and type of goods described in the accepted purchase order and that such goods will be free from defects in material and workmanship.

THIS LIMITED WARRANTY IS SELLER'S SOLE AND EXCLUSIVE WARRANTY. SELLER MAKES NO OTHER WARRANTY OF ANY KIND, EXPRESS OR IMPLIED. SELLER DOES NOT WARRANT THAT THE GOODS ARE FIT FOR ANY PARTICULAR PURPOSE. SELLER DOES NOT WARRANT THAT THE GOODS ARE MERCHANTABILITY.

13. Product Disclaimers. All tooling required to manufacture products are the property of Seller even if tooling costs are incurred by Purchaser. Seller has the right to change product design, engineering, materials, tooling and processes that do not affect the intended use and application of the product. Seller will notify Purchaser if changes are substantial and may affect the application or appearance of the product. Furthermore, references to Buyer's specifications and similar requirements are only to describe the goods and do not give rise to any representation, warranty or other sales term.

Seller manufactures to industry standards and makes every effort to address applications of its products. Please see current technical advisory at Seller's web site, sipindustries.com, for up to date product support and recommendations. All product dimension, designs, technology, tooling, process, software, innovations, and drawings are considered intellectual property and are owned and confidential to Seller. Purchaser has no rights or privileges to SIP industries intellectual property including product applications without Seller's express written consent.

14. Prompt notice required for Limited Warranty claims. Buyer is responsible for promptly inspecting goods on delivery and notifying Seller, within sixty (60) days of delivery to Buyer, of any nonconformity or defect that would be discovered on a reasonable and customary inspection. Provided that such notice is given and that the warranty claim is made within one year, Seller will provide a replacement or price adjustment, in Seller's discretion, not to exceed the net sales price of the defective product. However, this warranty shall be of no force or effect absent such timely notice. Seller shall not in any event be responsible for labor, removal or installation charges incurred in connection with the replacement of defective goods.

15. Conditions to Limited Warranty. Purchaser shall notify Seller immediately upon discovery of a defect so that Seller may inspect the product in its installed condition. Seller shall not be responsible for defects or failures in goods of which it is not so notified; nor shall Seller be responsible for goods manufactured or sold by other parties or losses or impairments caused by such goods; nor shall Seller be responsible for defects or failure of goods due to improper installation, improper usage, normal or abnormal wear and tear, erosion or corrosion, improper storage, use or maintenance, vandalism, vehicular or other accidents, or storms or other forces beyond the control of the parties. Seller also shall not be responsible for goods that have been damaged by misuse, negligence or accident or that have been altered or repaired by any party other than Seller.

16. Limitation on Liability. In the event any remedy hereunder fails of its essential purpose and monetary damages may be imposed, Seller's liability, whether founded in contract or tort (including negligence), arising out of or resulting from (i) the Purchase Order and resulting contract or the performance or breach thereof, or (ii) the design, manufacture, delivery, sale, repair, replacement or use of the goods, shall not exceed the cost of the goods at issue in the claim. NOTWITHSTANDING ANYTHING CONTAINED HEREIN TO THE CONTRARY, SELLER SHALL NOT BE LIABLE TO PURCHASER OR ANY OTHER PERSON FOR CONSEQUENTIAL, INCIDENTAL, SPECIAL, EXEMPLARY, PUNITIVE OR OTHER INDIRECT DAMAGES, INCLUDING, WITHOUT LIMITATION, LOSS OF PROFITS, RECALL-RELATED EXPENSES, AND LOSS OF USE OF THE GOODS.

17. Purchaser specifications. If Seller has designed the goods using information provided by Purchaser, Seller shall not be responsible for design errors resulting from inaccurate or incomplete information supplied by Purchaser. If

Purchaser has provided specifications or a model or sample from which a good is designed and manufactured, Seller shall not be responsible for any defect, error or inadequacy provided that the good is designed or manufactured in compliance with Purchaser's specifications, model or sample.

18. Solvency and Security Interest. By submitting a Purchase Order, Buyer represents to Seller that Buyer is solvent and capable of timely fulfilling its payment and other obligations to Seller. Until the goods and any other indebtedness of Buyer have been paid in full, Buyer, its agents any successors: (i) will hold the goods subject to a security interest in favor of Seller allowing for the right or re-possession by Seller to the extent permitted by applicable law, (ii) will not alter, remove, destroy, or damage any identifying mark on the goods or their packaging, and (iii) will keep the goods separate from any other products.

19. Governing law; venue. All sales shall be governed by the law of the state of Texas. In the event that a lawsuit is filed between the parties on any claim arising out of or in connection with such sales, Seller and Purchaser agree that exclusive venue and jurisdiction shall be in the state or federal courts of Harris County, Texas.

20. Attorney's fees and costs. In the event of litigation between the parties with respect to the sale of goods, the prevailing party shall be entitled to recover its reasonable attorney's fees and costs, including expert witness fees.

Utility Pipe Fittings P401 Lined

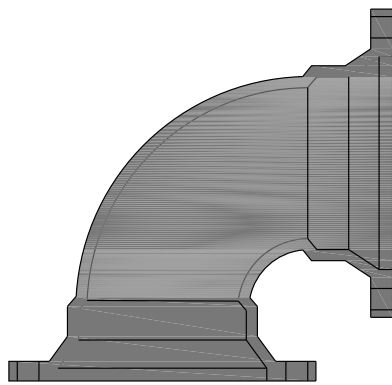

ANSI/AWWA C153/A21.53
COMPACT MJ FITTINGS
P401 LINED

PRICE LIST

Effective January 14, 2019.

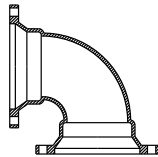
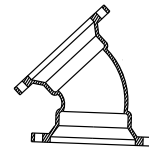

BENDS : MJ X MJ
90° (1/4)

BENDS : MJ X MJ
45° (1/8)

Size (in)	Item No.	Crt. Qty.	List Price (\$)	Wt. (lb.)
2	CDMJB9002P401	36	POA	14
3	CDMJB9003P401	80	302.00	23
4	CDMJB9004P401	60	361.00	27
6	CDMJB9006P401	36	564.00	39
8	CDMJB9008P401	18	787.00	57
10	CDMJB9010P401	12	1,107.00	89
12	CDMJB9012P401	8	1,414.00	108
14	CDMJB9014P401	4	2,052.00	210
16	CDMJB9016P401	2	2,501.00	264
18	CDMJB9018P401		2,987.00	335
20	CDMJB9020P401		3,723.00	400
24	CDMJB9024P401		5,287.00	565
30	CDMJB9030P401		8,686.00	960
36	CDMJB9036P401		12,987.00	1499
42	CDMJB9042P401		21,625.00	2205
48	CDMJB9048P401		28,418.00	2990

Size (in)	Item No.	Crt. Qty.	List Price (\$)	Wt. (lb.)
2	CDMJB4502P401	36	POA	13
3	CDMJB4503P401	80	285.00	21
4	CDMJB4504P401	100	334.00	23
6	CDMJB4506P401	48	517.00	32
8	CDMJB4508P401	27	714.00	46
10	CDMJB4510P401	18	954.00	70
12	CDMJB4512P401	12	1,278.00	86
14	CDMJB4514P401	8	1,759.00	164
16	CDMJB4516P401	8	2,114.00	202
18	CDMJB4518P401	2	2,461.00	250
20	CDMJB4520P401		2,979.00	305
24	CDMJB4524P401		3,921.00	405
30	CDMJB4530P401		7,533.00	783
36	CDMJB4536P401		10,570.00	1142
42	CDMJB4542P401		15,860.00	1610
48	CDMJB4548P401		20,420.00	2090

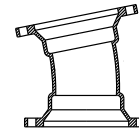
BENDS : MJ X MJ
22½° (1/16)

BENDS : MJ X MJ
11¼° (1/32)

Size (in)	Item No.	Crt. Qty.	List Price (\$)	Wt. (lb.)
2	CDMJB2202P401	50	POA	9
3	CDMJB2203P401	50	330.00	16
4	CDMJB2204P401	100	330.00	18
6	CDMJB2206P401	48	500.00	32
8	CDMJB2208P401	27	709.00	46
10	CDMJB2210P401	18	953.00	64
12	CDMJB2212P401	12	1,196.00	84
14	CDMJB2214P401	8	1,770.00	148
16	CDMJB2216P401	8	2,063.00	178
18	CDMJB2218P401	2	2,449.00	255
20	CDMJB2220P401	2	3,096.00	310
24	CDMJB2224P401	2	3,827.00	412
30	CDMJB2230P401		6,655.00	796
36	CDMJB2236P401		9,232.00	1160
42	CDMJB2242P401		13,337.00	1350
48	CDMJB2248P401		17,193.00	1760

Size (in)	Item No.	Crt. Qty.	List Price (\$)	Wt. (lb.)
2	CDMJB1102P401	30	POA	8
3	CDMJB1103P401	30	323.00	14
4	CDMJB1104P401	50	323.00	16
6	CDMJB1106P401	60	506.00	30
8	CDMJB1108P401	27	684.00	42
10	CDMJB1110P401	18	951.00	58
12	CDMJB1112P401	16	1,158.00	74
14	CDMJB1114P401	8	1,918.00	130
16	CDMJB1116P401	4	2,132.00	158
18	CDMJB1118P401	2	2,849.00	205
20	CDMJB1120P401	2	2,975.00	245
24	CDMJB1124P401	2	3,830.00	315
30	CDMJB1130P401		6,749.00	800
36	CDMJB1136P401		8,963.00	1165
42	CDMJB1142P401		12,956.00	1180
48	CDMJB1148P401		17,092.00	1475

* AWWA C110

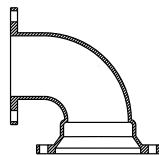
BENDS : MJ X FE
90° (1/4)

Size (in)	Item No.	Crt. Qty.	List Price (\$)	Wt. (lb.)
3	CDMJFB9003P401	72	383.00	20
4	CDMJFB9004P401	48	383.00	26
6	CDMJFB9006P401	27	626.00	47
8	CDMJFB9008P401	18	965.00	68
10	CDMJFB9010P401	12	1,415.00	102
12	CDMJFB9012P401	8	1,914.00	134
14	CDMJFB9014P401	4	3,358.00	223
16	CDMJFB9016P401	4	3,682.00	303
24	CDMJFB9024P401		POA	617
30	CDMJFB9030P401		POA	1014

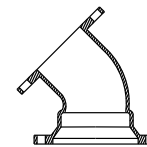
BENDS : MJ X FE
45° (1/8)

Size (in)	Item No.	Crt. Qty.	List Price (\$)	Wt. (lb.)
3	CDMJFB4503P401	32	POA	17
4	CDMJFB4504P401	100	403.00	24
6	CDMJFB4506P401	48	598.00	39
8	CDMJFB4508P401	27	939.00	57
10	CDMJFB4510P401	18	1,360.00	83
12	CDMJFB4512P401	12	1,888.00	111
14	CDMJFB4514P401	8	2,635.00	208
16	CDMJFB4516P401	8	3,293.00	240
24	CDMJFB4524P401		POA	617
30	CDMJFB4530P401		POA	1014

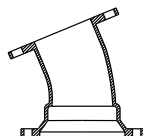
BENDS : MJ X FE
22½° (1/16)

Size (in)	Item No.	Crt. Qty.	List Price (\$)	Wt. (lb.)
3	CDMJFB2203P401	24	POA	18
4	CDMJFB2204P401	100	575.00	27
6	CDMJFB2206P401	48	703.00	36
8	CDMJFB2208P401	27	1,043.00	53
10	CDMJFB2210P401	18	1,347.00	100
12	CDMJFB2212P401	12	1,868.00	145
30	CDMJFB2230P401		POA	

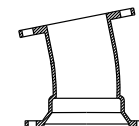
BENDS : MJ X FE
11¼° (1/32)

Size (in)	Item No.	Crt. Qty.	List Price (\$)	Wt. (lb.)
4	CDMJFB1104P401	100	501.00	20
6	CDMJFB1106P401	48	680.00	30
8	CDMJFB1108P401	27	883.00	50
10	CDMJFB1110P401	18	1,296.00	74
12	CDMJFB1112P401	12	1,610.00	85

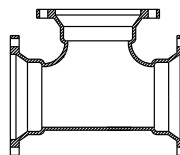
TEES : MJ X MJ

Size (in)	Item No.	Crt. Qty.	List Price (\$)	Wt. (lb.)
2 X 2	CDMJT0202P401		POA	22
3 X 2	CDMJT0302P401		POA	43
3 X 3	CDMJT0303P401	50	410.00	28
4 X 2	CDMJT0402P401	36	POA	29
4 X 3	CDMJT0403P401	16	410.00	35
4 X 4	CDMJT0404P401	60	410.00	32
6 X 3	CDMJT0603P401	12	599.00	42
6 X 4	CDMJT0604P401	36	654.00	46
6 X 4 X 6	CDMJT060406P401	12	POA	60
6 X 6	CDMJT0606P401	24	682.00	56

Size (in)	Item No.	Crt. Qty.	List Price (\$)	Wt. (lb.)
6 X 6 X 8	CDMJT060608P401	25	POA	75
8 X 3	CDMJT0803P401	9	876.00	52
8 X 4	CDMJT0804P401	27	810.00	60
8 X 6	CDMJT0806P401	18	875.00	72
8 X 6 X 6	CDMJT080606P401	9	POA	75
8 X 6 X 8	CDMJT080608P401	9	POA	85
8 X 8	CDMJT0808P401	18	967.00	86
10X 3	CDMJT1003P401	6	1,121.00	75
10X 4	CDMJT1004P401	18	1,126.00	78
10X 6	CDMJT1006P401	12	1,109.00	90

* AWWA C110

Contd.....

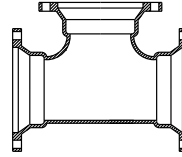
TEES : MJ X MJ
Contd.....

Size (in)	Item No.	Crt. Qty.	List Price (\$)	Wt. (lb.)
10X 8	CDMJT1008P401	12	1,207.00	105
10X10	CDMJT1010P401	12	1,307.00	120
12X 3	CDMJT1203P401		1,451.00	90
12X 4	CDMJT1204P401	12	1,366.00	94
12X 6	CDMJT1206P401	8	1,366.00	110
12X 8	CDMJT1208P401	8	1,483.00	125
12X10	CDMJT1210P401	8	1,731.00	140
12X12	CDMJT1212P401	8	1,725.00	160
14X 6	CDMJT1406P401	8	1,979.00	182
14X 8	CDMJT1408P401	8	2,151.00	206
14X10	CDMJT1410P401	8	2,648.00	228
14X12	CDMJT1412P401	4	2,800.00	234
14X14	CDMJT1414P401	4	2,561.00	280
16X 6	CDMJT1606P401	4	2,368.00	228
16X 8	CDMJT1608P401	4	2,501.00	248
16X10	CDMJT1610P401	2	3,044.00	264
16X12	CDMJT1612P401	4	2,830.00	280
16X14	CDMJT1614P401	4	3,762.00	316
16X16	CDMJT1616P401	4	3,354.00	322
18X 6	CDMJT1806P401		3,117.00	287
18X 8	CDMJT1808P401		3,296.00	295
18X10	CDMJT1810P401		3,512.00	325
18X12	CDMJT1812P401		3,737.00	340
18X14	CDMJT1814P401		4,843.00	380
18X16	CDMJT1816P401		5,014.00	425
18X18	CDMJT1818P401		4,589.00	450
20X 6	CDMJT2006P401		3,491.00	320
20X 8	CDMJT2008P401		3,549.00	366
20X10	CDMJT2010P401		4,681.00	370
20X12	CDMJT2012P401		4,146.00	395
20X14	CDMJT2014P401		5,214.00	475
20X16	CDMJT2016P401		4,097.00	505
20X18	CDMJT2018P401		6,433.00	505
20X20	CDMJT2020P401		4,408.00	550
24X 6	CDMJT2406P401		4,196.00	415
24X 8	CDMJT2408P401		4,233.00	445
24X10	CDMJT2410P401		5,262.00	470
24X12	CDMJT2412P401		4,433.00	500
24X14	CDMJT2414P401		6,367.00	550

Size (in)	Item No.	Crt. Qty.	List Price (\$)	Wt. (lb.)
24X16	CDMJT2416P401		5,342.00	580
24X18	CDMJT2418P401		6,693.00	625
24X20	CDMJT2420P401		6,862.00	660
24X24	CDMJT2424P401		6,319.00	720
30X 6	CDMJT3006P401		6,935.00	742
30X 8	CDMJT3008P401		7,645.00	755
30X12	CDMJT3012P401		8,413.00	817
30X16	CDMJT3016P401		POA	931
30X18	CDMJT3018P401		POA	1085
30X20	CDMJT3020P401		9,333.00	995
30X24	CDMJT3024P401		9,690.00	1389
30X30	CDMJT3030P401		11,702.00	1318
36X 6	CDMJT3606P401		POA	1000
36X 8	CDMJT3608P401		POA	1050
36X12	CDMJT3612P401		POA	1150
36X16	CDMJT3616P401		POA	1167
36X18	CDMJT3618P401		20,209.00	1505
36X20	CDMJT3620P401		POA	1520
36X24	CDMJT3624P401		12,961.00	1498
36X30	CDMJT3630P401		17,088.00	2381
36X36	CDMJT3636P401		21,261.00	2065
42X 6	CDMJT4206P401		POA	1800
42X12	CDMJT4212P401		POA	1950
42X16	CDMJT4216P401		POA	2040
42X18	CDMJT4218P401		POA	2195
42X20	CDMJT4220P401		POA	2235
42X24	CDMJT4224P401		POA	2270
42X30	CDMJT4230P401		POA	2608
42X36	CDMJT4236P401		26,575.00	3000
42X42	CDMJT4242P401		28,053.00	3175
48X 6	CDMJT4806P401		POA	2155
48X16	CDMJT4816P401		POA	2650
48X24	CDMJT4824P401		POA	2870
48X30	CDMJT4830P401		POA	3050
48X36	CDMJT4836P401		35,007.00	3900
48X42	CDMJT4842P401		41,238.00	4100
48X48	CDMJT4848P401		37,204.00	4250

* AWWA C110

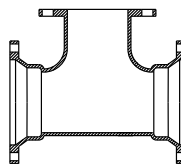
TEES : MJ X FE

Size (in)	Item No.	Crt. Qty.	List Price (\$)	Wt. (lb.)
3 X 3	CDMJFT0303P401	40	559.00	30
4 X 3	CDMJFT0403P401	16	656.00	34
4 X 4	CDMJFT0404P401	36	620.00	38
6 X 3	CDMJFT0603P401	12	904.00	51
6 X 4	CDMJFT0604P401	36	942.00	54
6 X 6	CDMJFT0606P401	24	942.00	62
8 X 4	CDMJFT0804P401	27	1,048.00	79
8 X 6	CDMJFT0806P401	18	1,088.00	80
8 X 8	CDMJFT0808P401	18	1,391.00	90
10X 4	CDMJFT1004P401	6	1,324.00	89
10X 6	CDMJFT1006P401	8	1,643.00	110
10X 8	CDMJFT1008P401	6	1,774.00	115
10X10	CDMJFT1010P401	4	2,259.00	130
12X 4	CDMJFT1204P401	8	1,670.00	117
12X 6	CDMJFT1206P401	8	1,760.00	133
12X 8	CDMJFT1208P401	8	1,955.00	135
12X10	CDMJFT1210P401	4	2,232.00	150
12X12	CDMJFT1212P401	4	2,803.00	170
14X 6	CDMJFT1406P401	8	2,470.00	185
14X 8	CDMJFT1408P401		POA	225
14X10	CDMJFT1410P401	8	3,542.00	244
14X12	CDMJFT1412P401	8	3,845.00	284
14X14	CDMJFT1414P401	8	4,130.00	305
16X 6	CDMJFT1606P401	2	2,510.00	210
16X 8	CDMJFT1608P401	2	3,039.00	260
16X10	CDMJFT1610P401	4	3,627.00	287
16X12	CDMJFT1612P401	4	3,737.00	312

Size (in)	Item No.	Crt. Qty.	List Price (\$)	Wt. (lb.)
16X14	CDMJFT1614P401	4	POA	348
16X16	CDMJFT1616P401	4	5,166.00	374
18X 6	CDMJFT1806P401	4	3,031.00	320
18X 8	CDMJFT1808P401	4	3,957.00	352
18X12	CDMJFT1812P401		POA	358
18X16	CDMJFT1816P401		POA	558
18X18	CDMJFT1818P401		POA	445
20X 6	CDMJFT2006P401	4	3,775.00	362
20X 8	CDMJFT2008P401		POA	384
20X10	CDMJFT2010P401		POA	391
24X 6	CDMJFT2406P401	2	4,105.00	408
24X 8	CDMJFT2408P401		POA	472
24X10	CDMJFT2410P401		POA	586
24X12	CDMJFT2412P401	2	5,780.00	580
24X16	CDMJFT2416P401	2	6,614.00	745
24X24	CDMJFT2424P401		POA	923
30X 6	CDMJFT3006P401		15,002.00	805
30X 8	CDMJFT3008P401		POA	695
30X12	CDMJFT3012P401		POA	715
30X16	CDMJFT3016P401		POA	1187
36X 6	CDMJFT3606P401		POA	1175
36X12	CDMJFT3612P401		POA	
36X16	CDMJFT3616P401		POA	1475
36X24	CDMJFT3624P401		POA	
42X12	CDMJFT4212P401		POA	
42X30	CDMJFT4224P401		POA	

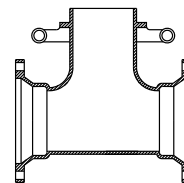
MJ X SWIVEL HYDRANT TEE (W/SWIVEL GLAND) ANCHOR TEE

Size (in)	Item No.	Crt. Qty.	List Price (\$)	Wt. (lb.)
6 X 6	CDMJHT0606P401	24	942.00	66
8 X 6	CDMJHT0806P401	18	1,128.00	86
8 X 8	CDMJHT0808P401	16	1,712.00	105
10X 6	CDMJHT1006P401	12	1,268.00	110
10X 8	CDMJHT1008P401	4	1,687.00	120
12X 6	CDMJHT1206P401	8	1,370.00	128

Size (in)	Item No.	Crt. Qty.	List Price (\$)	Wt. (lb.)
12X 8	CDMJHT1208P401	4	2,053.00	130
14X 6	CDMJHT1406P401	8	2,797.00	211
16X 6	CDMJHT1606P401	4	1,898.00	280
16X 8	CDMJHT1608P401	4	POA	296
18X 6	CDMJHT1806P401		3,269.00	280
20X 6	CDMJHT2006P401		2,893.00	360
24X 6	CDMJHT2406P401		3,984.00	465

* AWWA C110

CROSSES : MJ X MJ

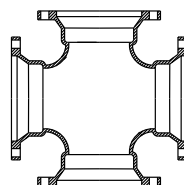

Size (in)	Item No.	Crt. Qty.	List Price (\$)	Wt. (lb.)
3 X 3	CDMJX0303P401		645.00	40
4 X 3	CDMJX0403P401		530.00	49
4 X 4	CDMJX0404P401	12	645.00	42
6 X 4	CDMJX0604P401	6	789.00	68
6 X 6	CDMJX0606P401	16	847.00	80
8 X 4	CDMJX0804P401	6	1,173.00	100
8 X 6	CDMJX0806P401	12	973.00	105
8 X 8	CDMJX0808P401	12	944.00	110
10X 4	CDMJX1004P401	4	1,292.00	120
10X 6	CDMJX1006P401	12	1,238.00	125
10X 8	CDMJX1008P401	8	1,457.00	130
10X10	CDMJX1010P401	8	1,458.00	145
12X 4	CDMJX1204P401	8	1,580.00	123
12X 6	CDMJX1206P401	8	1,528.00	140
12X 8	CDMJX1208P401	8	1,666.00	155
12X10	CDMJX1210P401	4	2,385.00	187
12X12	CDMJX1212P401	8	2,272.00	215
14X 6	CDMJX1406P401	8	2,474.00	210
14X 8	CDMJX1408P401	8	2,709.00	230
14X10	CDMJX1410P401		3,556.00	255
14X12	CDMJX1412P401		4,342.00	270
14X14	CDMJX1414P401	4	3,630.00	336
16X 6	CDMJX1606P401	4	2,807.00	250
16X 8	CDMJX1608P401		3,117.00	264
16X10	CDMJX1610P401		3,817.00	285
16X12	CDMJX1612P401		3,973.00	310
16X14	CDMJX1614P401		POA	398
16X16	CDMJX1616P401		5,408.00	390
18X 6	CDMJX1806P401		POA	392

Size (in)	Item No.	Crt. Qty.	List Price (\$)	Wt. (lb.)
18X12	CDMJX1812P401		POA	437
18X18	CDMJX1818P401		POA	657
20X 6	CDMJX2006P401		POA	298
20X 8	CDMJX2008P401		POA	440
20X12	CDMJX2012P401		POA	558
20X16	CDMJX2016P401		POA	632
20X18	CDMJX2018P401		POA	698
20X20	CDMJX2020P401		POA	798
24X 6	CDMJX2406P401		POA	481
24X 8	CDMJX2408P401		POA	500
24X12	CDMJX2412P401		POA	620
24X16	CDMJX2416P401		POA	720
24X18	CDMJX2418P401		POA	868
24X20	CDMJX2420P401		POA	1014
24X24	CDMJX2424P401		9,674.00	1038
30X12	CDMJX3012P401		POA	1130
30X16	CDMJX3016P401		POA	880
30X24	CDMJX3024P401		POA	1640
30X30	CDMJX3030P401		POA	1840
36X24	CDMJX3624P401		POA	1955
36X36	CDMJX3636P401		POA	2655
42X24	CDMJX4224P401		POA	2668
42X30	CDMJX4230P401		POA	2950
42X36	CDMJX4236P401		POA	3375
42X42	CDMJX4242P401		POA	3725
48X24	CDMJX4824P401		POA	3682
48X30	CDMJX4830P401		POA	4506
48X36	CDMJX4836P401		POA	4700
48X42	CDMJX4842P401		POA	4751
48X48	CDMJX4848P401		POA	4955

TEES : MJ X PE X MJ

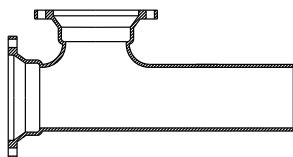

Size (in)	Item No.	Crt. Qty.	List Price (\$)	Wt. (lb.)
6	CDMJPEMJT06P401		937.00	57
8 X 6	CDMJPEMJT0806P401		1,186.00	69
8	CDMJPEMJT08P401	9	1,405.00	77
10	CDMJPEMJT10P401		1,841.00	120
12	CDMJPEMJT12P401		2,627.00	168

* AWWA C110

P 4 0 1 P 4 0 1 P 4 0 1 P 4 0 1 P 4 0 1 P 4 0 1 P 4 0 1 P 4 0 1 P 4 0 1 P 4 0 1

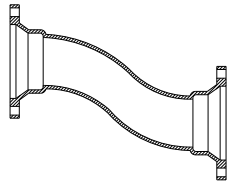
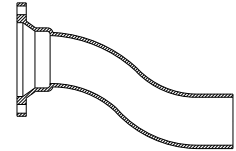
MJ OFFSET

MJ X PE OFFSET

Size (in)	Item No.	Crt. Qty.	List Price (\$)	Wt. (lb.)
3 X 6	CDMJO0306P401		POA	30
3 X 12	CDMJO0312P401		POA	40
3 X 18	CDMJO0318P401		POA	49
3 X 24	CDMJO0324P401		POA	55
4 X 6	CDMJO0406P401	12	POA	25
4 X 12	CDMJO0412P401	12	POA	55
4 X 18	CDMJO0418P401	8	POA	65
4 X 24	CDMJO0424P401	16	POA	75
6 X 6	CDMJO0606P401	12	POA	29
6 X 12	CDMJO0612P401	16	POA	69
6 X 18	CDMJO0618P401	8	POA	87
6 X 24	CDMJO0624P401	8	POA	107
8 X 6	CDMJO0806P401	4	POA	80
8 X 12	CDMJO0812P401	4	POA	104
8 X 18	CDMJO0818P401	4	POA	135
8 X 24	CDMJO0824P401	3	POA	141
10 X 6	CDMJO1006P401	4	POA	110
10 X 12	CDMJO1012P401	4	POA	135
10 X 18	CDMJO1018P401	4	POA	165
10 X 24	CDMJO1024P401	4	POA	175
12 X 6	CDMJO1206P401	4	POA	118
12 X 12	CDMJO1212P401	4	POA	203
12 X 18	CDMJO1218P401	4	POA	230
12 X 24	CDMJO1224P401	2	POA	277
12 X 30	CDMJO1230P401		POA	285
16 X 12	CDMJO1612P401		POA	305
16 X 18	CDMJO1618P401		POA	362
20 X 12	CDMJO2012P401		POA	437
20 X 18	CDMJO2018P401		POA	581

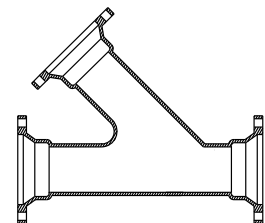
Size (in)	Item No.	Crt. Qty.	List Price (\$)	Wt. (lb.)
3 X 6	CDMJOP0306P401		POA	32
3 X 12	CDMJOP0312P401		POA	42
3 X 18	CDMJOP0318P401		POA	54
3 X 24	CDMJOP0324P401		POA	58
4 X 6	CDMJOP0406P401	12	POA	45
4 X 12	CDMJOP0412P401	12	POA	56
4 X 18	CDMJOP0418P401	16	POA	62
4 X 24	CDMJOP0424P401	6	POA	70
6 X 6	CDMJOP0606P401	12	POA	55
6 X 12	CDMJOP0612P401	8	POA	68
6 X 18	CDMJOP0618P401	8	POA	97
6 X 24	CDMJOP0624P401	4	POA	116
8 X 6	CDMJOP0806P401	4	POA	84
8 X 12	CDMJOP0812P401	4	POA	110
8 X 18	CDMJOP0818P401	4	POA	124
8 X 24	CDMJOP0824P401	3	POA	147
10 X 6	CDMJOP1006P401	6	POA	127
10 X 12	CDMJOP1012P401	4	POA	130
10 X 18	CDMJOP1018P401	4	POA	160
10 X 24	CDMJOP1024P401	4	POA	169
12 X 6	CDMJOP1206P401	4	POA	115
12 X 12	CDMJOP1212P401	4	POA	198
12 X 18	CDMJOP1218P401	4	POA	270
12 X 24	CDMJOP1224P401	2	POA	335
12 X 30	CDMJOP1230P401		POA	225

MJ 45° LATERAL (WYES)

Size (in)	Item No.	Crt. Qty.	List Price (\$)	Wt. (lb.)
3 X 3	CDMJL0303P401		561.00	36
4 X 3	CDMJL0403P401		682.00	40
4 X 4	CDMJL0404P401	30	774.00	42
6 X 4	CDMJL0604P401	12	798.00	53
6 X 6	CDMJL0606P401	16	1,118.00	85
8 X 4	CDMJL0804P401	6	1,476.00	75

Size (in)	Item No.	Crt. Qty.	List Price (\$)	Wt. (lb.)
8 X 6	CDMJL0806P401	6	1,236.00	92
8 X 8	CDMJL0808P401	6	1,560.00	105
10X 4	CDMJL1004P401	4	2,200.00	147
10X 6	CDMJL1006P401	4	2,315.00	156
10X 8	CDMJL1008P401	4	2,521.00	172
10X10	CDMJL1010P401	4	3,077.00	212

* AWWA C110

Contd.....

MJ 45° LATERAL (WYES)

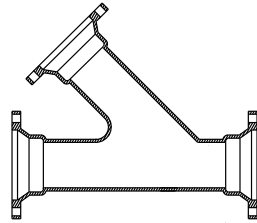

Size (in)	Item No.	Crt. Qty.	List Price (\$)	Wt. (lb.)
12X 4	CDMJL1204P401	2	2,987.00	185
12X 6	CDMJL1206P401	2	3,107.00	187
12X 8	CDMJL1208P401	2	3,336.00	190
12X10	CDMJL1210P401	2	3,919.00	245
12X12	CDMJL1212P401	2	3,478.00	275
14X 6	CDMJL1406P401	2	4,948.00	248
14X 8	CDMJL1408P401	2	POA	281
14X10	CDMJL1410P401	2	POA	320
14X14	CDMJL1414P401	2	5,460.00	474
16X 6	CDMJL1606P401	2	3,277.00	300
16X 8	CDMJL1608P401	2	3,842.00	349
16X10	CDMJL1610P401		POA	372
16X12	CDMJL1612P401		4,931.00	453
16X16	CDMJL1616P401	2	5,992.00	575
18X 6	CDMJL1806P401		POA	408
18X10	CDMJL1810P401		POA	485
18X12	CDMJL1812P401		POA	510
18X18	CDMJL1818P401		POA	808
20X20	CDMJL2020P401		POA	1525
24X10	CDMJL2410P401		POA	1800
24X12	CDMJL2412P401		POA	900
24X16	CDMJL2416P401		POA	1815
24X18	CDMJL2418P401		POA	1047
24X24	CDMJL2424P401		POA	1269
30X20	CDMJL3020P401		POA	2575
30X24	CDMJL3024P401		POA	1575
30X30	CDMJL3030P401		POA	1269
36X 8	CDMJL3608P401		POA	1430
36X20	CDMJL3620P401		POA	2032
36X30	CDMJL3630P401		POA	5080
36X36	CDMJL3636P401		POA	2280
42X24	CDMJL4224P401		POA	3400
42X42	CDMJL4242P401		POA	4438
48X18	CDMJL4818P401		POA	3502
48X20	CDMJL4820P401		POA	3695
48X24	CDMJL4824P401		POA	4313
48X30	CDMJL4830P401		POA	4522
48X48	CDMJL4848P401		POA	5907

MJ LONG SLEEVES

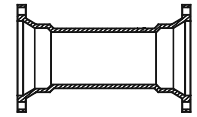

Size (in)	Item No.	Crt. Qty.	List Price (\$)	Wt. (lb.)
2	CDMJLS02P401	50	POA	7
3	CDMJLS03P401	126	334.00	17
4	CDMJLS04P401	75	334.00	20
6	CDMJLS06P401	36	539.00	29
8	CDMJLS08P401	27	789.00	45
10	CDMJLS10P401	18	965.00	61
12	CDMJLS12P401	12	1,226.00	76
14	CDMJLS14P401	8	1,639.00	128
16	CDMJLS16P401	8	1,985.00	159
18	CDMJLS18P401	5	2,413.00	200
20	CDMJLS20P401	5	2,825.00	236
24	CDMJLS24P401	5	3,600.00	306
30	CDMJLS30P401		6,490.00	634
36	CDMJLS36P401		8,494.00	889
42	CDMJLS42P401		11,285.00	1150
48	CDMJLS48P401		17,279.00	1435

MJ SHORT SLEEVES

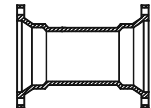

Size (in)	Item No.	Crt. Qty.	List Price (\$)	Wt. (lb.)
2	CDMJSS02P401		POA	12
3	CDMJSS03P401	50	257.00	13
4	CDMJSS04P401	125	305.00	17
6	CDMJSS06P401	60	484.00	28
8	CDMJSS08P401	45	642.00	38
10	CDMJSS10P401	30	927.00	49
12	CDMJSS12P401	20	1,082.00	56
14	CDMJSS14P401	16	1,614.00	111
16	CDMJSS16P401	16	1,938.00	130
18	CDMJSS18P401	2	2,346.00	160
20	CDMJSS20P401	8	2,772.00	195
24	CDMJSS24P401	2	3,552.00	255
30	CDMJSS30P401		6,391.00	500
36	CDMJSS36P401		8,447.00	725
42	CDMJSS42P401		11,576.00	877
48	CDMJSS48P401		14,255.00	1136

* AWWA C110

P401 P401 P401 P401 P401 P401 P401 P401 P401 P401

MJ CAPS : SOLID

Size (in)	Item No.	Crt. Qty.	List Price (\$)	Wt. (lb.)
2	CDMJC02P401		POA	6
3	CDMJC03P401	300	194.00	8
4	CDMJC04P401	240	238.00	10
6	CDMJC06P401	144	379.00	17
8	CDMJC08P401	108	544.00	22
10	CDMJC10P401	72	685.00	32
12	CDMJC12P401	52	918.00	42
14	CDMJC14P401	36	1,055.00	70
16	CDMJC16P401	20	1,325.00	98
18	CDMJC18P401	20	1,573.00	120
20	CDMJC20P401	20	1,927.00	130
24	CDMJC24P401	10	2,533.00	170
30	CDMJC30P401	2	4,988.00	385
36	CDMJC36P401	2	8,474.00	614
42	CDMJC42P401		POA	893
48	CDMJC48P401		POA	1067

MJ CAPS : 2" TAPPED

Size (in)	Item No.	Crt. Qty.	List Price (\$)	Wt. (lb.)
2	CDMJCT02P401		POA	10
3	CDMJCT03P401	300	282.00	8
4	CDMJCT04P401	240	328.00	10
6	CDMJCT06P401	144	469.00	17
8	CDMJCT08P401	108	635.00	22
10	CDMJCT10P401	72	777.00	32
12	CDMJCT12P401	52	1,010.00	42
14	CDMJCT14P401	36	1,181.00	70
16	CDMJCT16P401	20	1,451.00	98
18	CDMJCT18P401	20	1,727.00	120
20	CDMJCT20P401	20	2,081.00	130
24	CDMJCT24P401	10	2,689.00	202
30	CDMJCT30P401	2	5,221.00	385
36	CDMJCT36P401	2	8,704.00	614
42	CDMJCT42P401		POA	893
48	CDMJCT48P401		POA	1076

MJ PLUGS : SOLID



Size (in)	Item No.	Crt. Qty.	List Price (\$)	Wt. (lb.)
2	CDMJPO2P401		POA	6
3	CDMJPO3P401	100	216.00	8
4	CDMJPO4P401	100	252.00	10
6	CDMJPO6P401	144	413.00	22
8	CDMJPO8P401	66	581.00	32
10	CDMJPO10P401	52	896.00	40
12	CDMJPO12P401	40	965.00	55
14	CDMJPO14P401	16	1,362.00	70
16	CDMJPO16P401	10	1,680.00	105
18	CDMJPO18P401	4	2,026.00	125
20	CDMJPO20P401	4	2,539.00	139
24	CDMJPO24P401	4	3,405.00	180
30	CDMJPO30P401	2	6,188.00	433
36	CDMJPO36P401	2	9,223.00	674
42	CDMJPO42P401		12,538.00	1067
48	CDMJPO48P401		16,912.00	1313

MJ PLUGS : 2" TAPPED

Size (in)	Item No.	Crt. Qty.	List Price (\$)	Wt. (lb.)
2	CDMJPT02P401		POA	5
3	CDMJPT03P401	300	343.00	8
4	CDMJPT04P401	240	343.00	10
6	CDMJPT06P401	144	505.00	22
8	CDMJPT08P401	108	673.00	32
10	CDMJPT10P401	66	986.00	40
12	CDMJPT12P401	24	1,055.00	55
14	CDMJPT14P401	32	1,485.00	70
16	CDMJPT16P401	20	1,804.00	105
18	CDMJPT18P401	20	2,182.00	125
20	CDMJPT20P401	20	2,694.00	139
24	CDMJPT24P401	10	3,560.00	180
30	CDMJPT30P401	2	6,421.00	433
36	CDMJPT36P401	2	9,455.00	674
42	CDMJPT42P401		13,468.00	1067
48	CDMJPT48P401		17,470.00	1313

* AWWA C110

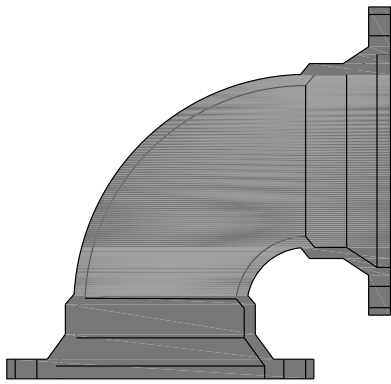
Utility Pipe Fittings P401 Lined



ANSI/AWWA C110/A21.10
FULL BODY MJ FITTINGS
P401 LINED

PRICE LIST
Effective January 14, 2019.

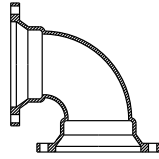
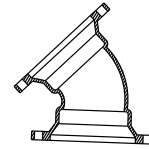

BENDS : MJ X MJ
90° (1/4)

BENDS : MJ X MJ
45° (1/8)

Size (in)	Item No.	Crt. Qty.	List Price (\$)	Wt. (lb.)
2	XDMJB9002P401	36	559.00	14
3	XDMJB9003P401	36	559.00	35
4	XDMJB9004P401	24	559.00	55
6	XDMJB9006P401	12	855.00	85
8	XDMJB9008P401	12	1,292.00	125
10	XDMJB9010P401	4	2,089.00	190
12	XDMJB9012P401	4	2,341.00	255
14	XDMJB9014P401	0	4,008.00	380
16	XDMJB9016P401	0	4,771.00	430
18	XDMJB9018P401	0	6,635.00	545
20	XDMJB9020P401	0	7,480.00	680
24	XDMJB9024P401	0	8,865.00	1025
30	XDMJB9030P401	0	16,328.00	1690
36	XDMJB9036P401	0	22,029.00	2475
42	XDMJB9042P401	0	39,020.00	3410
48	XDMJB9048P401	0	52,825.00	4595

Size (in)	Item No.	Crt. Qty.	List Price (\$)	Wt. (lb.)
2	XDMJB4502P401	36	526.00	13
3	XDMJB4503P401	0	526.00	30
4	XDMJB4504P401	36	526.00	50
6	XDMJB4506P401	12	789.00	75
8	XDMJB4508P401	12	1,118.00	110
10	XDMJB4510P401	4	1,653.00	155
12	XDMJB4512P401	4	2,060.00	215
14	XDMJB4514P401	0	3,135.00	270
16	XDMJB4516P401	0	3,855.00	340
18	XDMJB4518P401	0	4,809.00	420
20	XDMJB4520P401	0	4,872.00	530
24	XDMJB4524P401	0	6,848.00	755
30	XDMJB4530P401	0	13,156.00	1380
36	XDMJB4536P401	0	19,304.00	2095
42	XDMJB4542P401	0	34,081.00	2955
48	XDMJB4548P401	0	46,579.00	4080

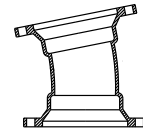
BENDS : MJ X MJ
22½° (1/16)

BENDS : MJ X MJ
11¼° (1/32)

Size (in)	Item No.	Crt. Qty.	List Price (\$)	Wt. (lb.)
2	XDMJB2202P401	0	POA	13
3	XDMJB2203P401	0	596.00	30
4	XDMJB2204P401	12	596.00	50
6	XDMJB2206P401	12	818.00	75
8	XDMJB2208P401	12	1,478.00	110
10	XDMJB2210P401	4	1,792.00	160
12	XDMJB2212P401	4	2,182.00	220
14	XDMJB2214P401	0	3,181.00	275
16	XDMJB2216P401	0	3,918.00	345
18	XDMJB2218P401	0	4,784.00	430
20	XDMJB2220P401	0	6,083.00	535
24	XDMJB2224P401	0	6,882.00	765
30	XDMJB2230P401	0	12,729.00	1400
36	XDMJB2236P401	0	18,858.00	2135
42	XDMJB2242P401	0	34,787.00	3020
48	XDMJB2248P401	0	47,556.00	4170

Size (in)	Item No.	Crt. Qty.	List Price (\$)	Wt. (lb.)
2	XDMJB1102P401	0	POA	13
3	XDMJB1103P401	0	596.00	30
4	XDMJB1104P401	12	596.00	50
6	XDMJB1106P401	12	897.00	75
8	XDMJB1108P401	12	1,158.00	110
10	XDMJB1110P401	0	1,792.00	160
12	XDMJB1112P401	6	2,411.00	220
14	XDMJB1114P401	0	3,181.00	275
16	XDMJB1116P401	0	3,918.00	345
18	XDMJB1118P401	0	4,908.00	430
20	XDMJB1120P401	0	6,103.00	540
24	XDMJB1124P401	0	8,096.00	770
30	XDMJB1130P401	0	18,858.00	1410
36	XDMJB1136P401	0	22,836.00	2145
42	XDMJB1142P401	0	34,947.00	3035
48	XDMJB1148P401	0	47,775.00	4190

BENDS : MJ X PE
90° (1/4)

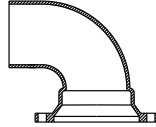

Size (in)	Item No.	Crt. Qty.	List Price (\$)	Wt. (lb.)
3	XDMJBP9003P401	0	POA	35
4	XDMJBP9004P401	8	POA	50
6	XDMJBP9006P401	12	POA	80
8	XDMJBP9008P401	12	POA	120
10	XDMJBP9010P401	8	POA	170
12	XDMJBP9012P401	4	POA	255
14	XDMJBP9014P401	0	POA	330
16	XDMJBP9016P401	0	POA	410
18	XDMJBP9018P401	0	POA	600
20	XDMJBP9020P401	0	POA	775
24	XDMJBP9024P401	0	POA	985
30	XDMJBP9030P401	0	POA	1920
36	XDMJBP9036P401	0	POA	2310
42	XDMJBP9042P401	0	POA	3215
48	XDMJBP9048P401	0	POA	4345

BENDS : MJ X PE
45° (1/8)

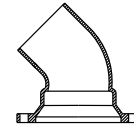

Size (in)	Item No.	Crt. Qty.	List Price (\$)	Wt. (lb.)
3	XDMJBP4503P401	24	POA	32
4	XDMJBP4504P401	50	POA	45
6	XDMJBP4506P401	12	POA	70
8	XDMJBP4508P401	24	POA	105
10	XDMJBP4510P401	12	POA	155
12	XDMJBP4512P401	4	POA	215
14	XDMJBP4514P401	4	POA	258
16	XDMJBP4516P401	4	POA	320
18	XDMJBP4518P401	0	POA	455
20	XDMJBP4520P401	0	POA	664
24	XDMJBP4524P401	2	POA	715
30	XDMJBP4530P401	0	POA	1510
36	XDMJBP4536P401	0	POA	1930
42	XDMJBP4542P401	0	POA	2745
48	XDMJBP4548P401	0	POA	3820

BENDS : MJ X PE
22½° (1/16)

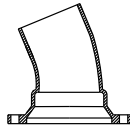

Size (in)	Item No.	Crt. Qty.	List Price (\$)	Wt. (lb.)
3	XDMJBP2203P401	24	POA	32
4	XDMJBP2204P401	24	POA	50
6	XDMJBP2206P401	0	POA	70
8	XDMJBP2208P401	0	POA	105
10	XDMJBP2210P401	0	POA	160
12	XDMJBP2212P401	0	POA	220
14	XDMJBP2214P401	4	POA	335
16	XDMJBP2216P401	0	POA	365
18	XDMJBP2218P401	0	POA	455
20	XDMJBP2220P401	0	POA	575
24	XDMJBP2224P401	0	POA	930
30	XDMJBP2230P401	0	POA	1540
36	XDMJBP2236P401	0	POA	1970
42	XDMJBP2242P401	0	POA	2815

BENDS : MJ X PE
11¼° (1/32)

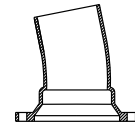

Size (in)	Item No.	Crt. Qty.	List Price (\$)	Wt. (lb.)
3	XDMJBP1103P401	24	POA	32
4	XDMJBP1104P401	24	POA	50
6	XDMJBP1106P401	24	POA	70
8	XDMJBP1108P401	16	POA	105
12	XDMJBP1112P401	0	POA	220
14	XDMJBP1114P401	0	POA	260
16	XDMJBP1116P401	2	POA	365
18	XDMJBP1118P401	0	POA	455
20	XDMJBP1120P401	0	POA	575
24	XDMJBP1124P401	0	POA	845
30	XDMJBP1130P401	0	POA	1305
36	XDMJBP1136P401	0	POA	2185
48	XDMJBP1148P401	0	POA	3945

P401 P401 P401 P401 P401 P401 P401 P401 P401 P401

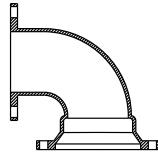
BENDS : MJ X FE
90° (1/4)

Size (in)	Item No.	Crt. Qty.	List Price (\$)	Wt. (lb.)
4	XDMJFB9004P401	0	POA	53
6	XDMJFB9006P401	0	POA	75
8	XDMJFB9008P401	2	POA	115
10	XDMJFB9010P401	0	POA	177
12	XDMJFB9012P401	0	POA	246
16	XDMJFB9016P401	0	POA	465
18	XDMJFB9018P401	0	POA	577
20	XDMJFB9020P401	0	POA	745
24	XDMJFB9024P401	0	POA	1150

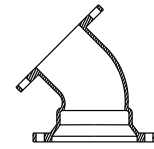
BENDS : MJ X FE
45° (1/8)

Size (in)	Item No.	Crt. Qty.	List Price (\$)	Wt. (lb.)
4	XDMJFB4504P401	0	POA	45
6	XDMJFB4506P401	0	POA	69
8	XDMJFB4508P401	0	POA	105
10	XDMJFB4510P401	0	POA	155
12	XDMJFB4512P401	0	POA	215
16	XDMJFB4516P401	0	POA	360
18	XDMJFB4518P401	0	POA	422
20	XDMJFB4520P401	0	POA	543
24	XDMJFB4524P401	0	POA	903

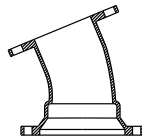
BENDS : MJ X FE
22½° (1/16)

Size (in)	Item No.	Crt. Qty.	List Price (\$)	Wt. (lb.)
4	XDMJFB2204P401	0	POA	45
6	XDMJFB2206P401	0	POA	69
8	XDMJFB2208P401	0	POA	105
10	XDMJFB2210P401	0	POA	155
12	XDMJFB2212P401	0	POA	215
16	XDMJFB2216P401	0	POA	373
18	XDMJFB2218P401	0	POA	422
20	XDMJFB2220P401	0	POA	575
24	XDMJFB2224P401	0	POA	800

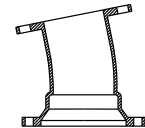
BENDS : MJ X FE
11¼° (1/32)

Size (in)	Item No.	Crt. Qty.	List Price (\$)	Wt. (lb.)
4	XDMJFB1104P401	0	POA	45
6	XDMJFB1106P401	0	POA	69
8	XDMJFB1108P401	0	POA	105
10	XDMJFB1110P401	0	POA	155
12	XDMJFB1112P401	0	POA	215
16	XDMJFB1116P401	0	POA	360
18	XDMJFB1118P401	0	POA	422
20	XDMJFB1120P401	0	POA	575
24	XDMJFB1124P401	0	POA	800

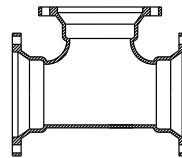
TEES : MJ X MJ

Size (in)	Item No.	Crt. Qty.	List Price (\$)	Wt. (lb.)
2 X 2	XDMJT0202P401	36	POA	22
3 X 2	XDMJT0302P401		POA	43
3 X 3	XDMJT0303P401		838.00	55
4 X 2	XDMJT0402P401	24	POA	65
4 X 3	XDMJT0403P401		829.00	75
4 X 4	XDMJT0404P401	12	838.00	80

Size (in)	Item No.	Crt. Qty.	List Price (\$)	Wt. (lb.)
4 X 4 X 6	XDMJT040406P401		POA	115
6 X 2	XDMJT0602P401	12	POA	100
6 X 3	XDMJT0603P401	24	1,177.00	110
6 X 4	XDMJT0604P401	12	1,219.00	115
6 X 6	XDMJT0606P401	12	1,169.00	125
6 X 6 X 8	XDMJT060608P401		POA	185

Contd.....

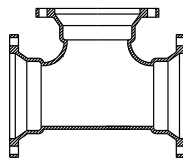

TEES : MJ X MJ
Contd.....

Size (in)	Item No.	Crt. Qty.	List Price (\$)	Wt. (lb.)
8 X 3	XDMJT0803P401		1,711.00	155
8 X 4	XDMJT0804P401	9	1,720.00	165
8 X 6	XDMJT0806P401	9	1,595.00	175
8 X 8	XDMJT0808P401	9	1,615.00	185
10 X 3	XDMJT1003P401		POA	216
10 X 4	XDMJT1004P401	12	2,551.00	235
10 X 6	XDMJT1006P401	4	2,532.00	250
10 X 8	XDMJT1008P401	4	2,612.00	260
10 X 10	XDMJT1010P401	4	3,027.00	310
12 X 3	XDMJT1203P401		POA	290
12 X 4	XDMJT1204P401	8	3,203.00	315
12 X 6	XDMJT1206P401	4	2,948.00	325
12 X 8	XDMJT1208P401	4	3,410.00	340
12 X 10	XDMJT1210P401	4	3,960.00	390
12 X 12	XDMJT1212P401	4	3,997.00	410
14 X 4	XDMJT1404P401		POA	383
14 X 6	XDMJT1406P401	4	4,642.00	435
14 X 8	XDMJT1408P401		4,778.00	450
14 X 10	XDMJT1410P401		4,915.00	465
14 X 12	XDMJT1412P401		5,189.00	495
14 X 14	XDMJT1414P401		5,416.00	520
16 X 4	XDMJT1604P401		POA	600
16 X 6	XDMJT1606P401		5,693.00	540
16 X 8	XDMJT1608P401		5,783.00	550
16 X 10	XDMJT1610P401		5,968.00	570
16 X 12	XDMJT1612P401		6,148.00	590
16 X 14	XDMJT1614P401		6,423.00	620
16 X 16	XDMJT1616P401		6,938.00	650
18 X 4	XDMJT1804P401		POA	528
18 X 6	XDMJT1806P401		6,245.00	590
18 X 8	XDMJT1808P401		6,384.00	605
18 X 10	XDMJT1810P401		6,518.00	620
18 X 12	XDMJT1812P401		6,701.00	640
18 X 14	XDMJT1814P401		7,751.00	755
18 X 16	XDMJT1816P401		8,025.00	785
18 X 18	XDMJT1818P401		8,341.00	820
20 X 6	XDMJT2006P401	2	8,205.00	725
20 X 8	XDMJT2008P401	2	9,348.00	735
20 X 10	XDMJT2010P401		7,849.00	755
20 X 12	XDMJT2012P401	2	7,918.00	775

Size (in)	Item No.	Crt. Qty.	List Price (\$)	Wt. (lb.)
20 X 14	XDMJT2014P401		8,211.00	795
20 X 16	XDMJT2016P401		9,458.00	945
20 X 18	XDMJT2018P401		9,944.00	985
20 X 20	XDMJT2020P401		8,524.00	1020
24 X 4	XDMJT2404P401		POA	985
24 X 6	XDMJT2406P401		10,137.00	985
24 X 8	XDMJT2408P401		10,271.00	1000
24 X 10	XDMJT2410P401		POA	1020
24 X 12	XDMJT2412P401		10,544.00	1030
24 X 14	XDMJT2414P401		10,773.00	1055
24 X 16	XDMJT2416P401		11,040.00	1075
24 X 18	XDMJT2418P401		13,919.00	1400
24 X 20	XDMJT2420P401		16,614.00	1450
24 X 24	XDMJT2424P401		17,470.00	1535
30 X 6	XDMJT3006P401		18,345.00	1730
30 X 8	XDMJT3008P401		18,488.00	1745
30 X 10	XDMJT3010P401		18,634.00	1760
30 X 12	XDMJT3012P401		18,832.00	1780
30 X 14	XDMJT3014P401		31,583.00	1800
30 X 16	XDMJT3016P401		26,699.00	1820
30 X 18	XDMJT3018P401		19,466.00	1845
30 X 20	XDMJT3020P401		19,761.00	1875
30 X 24	XDMJT3024P401		24,890.00	2400
30 X 30	XDMJT3030P401		27,841.00	2595
36 X 6	XDMJT3606P401		27,157.00	2439
36 X 8	XDMJT3608P401		26,349.00	2520
36 X 10	XDMJT3610P401		POA	2535
36 X 12	XDMJT3612P401		26,646.00	2550
36 X 14	XDMJT3614P401		26,840.00	2570
36 X 16	XDMJT3616P401		59,639.00	2585
36 X 18	XDMJT3618P401		60,832.00	2610
36 X 20	XDMJT3620P401		61,401.00	2635
36 X 24	XDMJT3624P401		62,641.00	2690
36 X 30	XDMJT3630P401		81,991.00	3545
36 X 36	XDMJT3636P401		81,888.00	3745
42 X 6	XDMJT4206P401		POA	3440
42 X 12	XDMJT4212P401		86,671.00	3555
42 X 14	XDMJT4214P401		1,16,212.00	3575
42 X 16	XDMJT4216P401		1,16,862.00	3595
42 X 18	XDMJT4218P401		1,17,512.00	3615

Contd.....

P 4 0 1 P 4 0 1 P 4 0 1 P 4 0 1 P 4 0 1 P 4 0 1 P 4 0 1 P 4 0 1 P 4 0 1 P 4 0 1

TEES : MJ X MJ

Contd.....

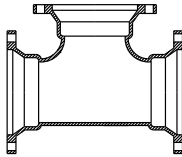

Size (in)	Item No.	Crt. Qty.	List Price (\$)	Wt. (lb.)
42 X 20	XDMJT4220P401		1,18,324.00	3640
42 X 24	XDMJT4224P401		89,961.00	3690
42 X 30	XDMJT4230P401		1,13,365.00	4650
42 X 36	XDMJT4236P401		1,18,974.00	6075
42 X 42	XDMJT4242P401		1,54,081.00	6320
48 X 12	XDMJT4812P401		1,18,730.00	4870
48 X 14	XDMJT4814P401		1,59,708.00	4885
48 X 16	XDMJT4816P401		1,59,446.00	4905
48 X 18	XDMJT4818P401		1,60,096.00	4925
48 X 20	XDMJT4820P401		1,60,908.00	4950
48 X 24	XDMJT4824P401		1,21,778.00	4995
48 X 30	XDMJT4830P401		1,25,314.00	5140
48 X 36	XDMJT4836P401		1,53,105.00	6280
48 X 42	XDMJT4842P401		1,98,208.00	8130
48 X 36 X 48	XDMJT483648P401		POA	6397
48 X 48	XDMJT4848P401		2,05,280.00	8420

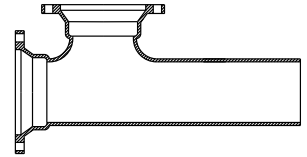
TEES : MJ X PE X MJ

Size (in)	Item No.	Crt. Qty.	List Price (\$)	Wt. (lb.)
4 X 4	XDMJPT0404P401		POA	75
6 X 6	XDMJPT0606P401		POA	120
8 X 4	XDMJPT0804P401	6	POA	160
8 X 6	XDMJPT0806P401		POA	170
8 X 8	XDMJPT0808P401		POA	180
10 X 10	XDMJPT1010P401		POA	250
12 X 4	XDMJPT1204P401		POA	315
12 X 6	XDMJPT1206P401		POA	325
12 X 8	XDMJPT1208P401		POA	340
12 X 10	XDMJPT1210P401		POA	390
12 X 12	XDMJPT1212P401		POA	410
14 X 14	XDMJPT1414P401		POA	500
16 X 8	XDMJPT1608P401	2	POA	530
16 X 16	XDMJPT1616P401		POA	625
24 X 6	XDMJPT2406P401	2	POA	945
24 X 8	XDMJPT2408P401		POA	960
24 X 12	XDMJPT2412P401		POA	990
24 X 16	XDMJPT2416P401		POA	1035
24 X 24	XDMJPT2424P401		POA	1490
36 X 12	XDMJPT3612P401		POA	2375
36 X 24	XDMJPT3624P401		POA	2515
36 X 36	XDMJPT3636P401		POA	3565

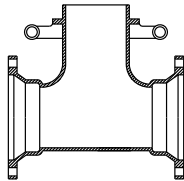
**MJ X SWIVEL
HYDRANT TEE
(W/SWIVEL GLAND)**

Size (in)	Item No.	Crt. Qty.	List Price (\$)	Wt. (lb.)
6 X 6	XDMJTH0606P401	9	POA	145
8 X 6	XDMJTH0806P401	9	POA	165
8 X 8	XDMJTH0808P401		POA	210
10 X 6	XDMJTH1006P401		POA	270
12 X 6	XDMJTH1206P401	4	POA	365
12 X 8	XDMJTH1208P401	4	POA	350
16 X 6	XDMJTH1606P401		POA	619
16 X 8	XDMJTH1608P401		POA	649
20 X 6	XDMJTH2006P401	2	POA	725
24 X 6	XDMJTH2406P401		POA	973
30 X 6	XDMJTH3006P401		POA	2070
36 X 6	XDMJTH3606P401		POA	2830

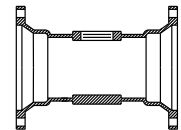
TEES : MJ TAPPED 2"

Size (in)	Item No.	Crt. Qty.	List Price (\$)	Wt. (lb.)
4 X 4	XDMJX0404TP401	0	POA	45
6 X 6	XDMJX0606TP401	0	POA	70
8 X 8	XDMJX0808TP401	0	POA	95
10 X 10	XDMJX1010TP401	0	POA	130
12 X 12	XDMJX1212TP401	0	POA	165
16 X 16	XDMJX1616TP401	0	POA	274
18 X 18	XDMJX1818TP401	0	POA	305
20 X 20	XDMJX2020TP401	0	POA	352
24 X 24	XDMJX2424TP401	0	POA	496

TEES : MJ X FE

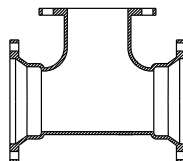

Size (in)	Item No.	Crt. Qty.	List Price (\$)	Wt. (lb.)
3 X 3	XDMJFT0303P401		POA	45
4 X 2	XDMJFT0402P401		POA	53
4 X 4	XDMJFT0404P401		949.00	74
6 X 3	XDMJFT0603P401		POA	115
6 X 4	XDMJFT0604P401		1,385.00	109
6 X 6	XDMJFT0606P401	2	1,477.00	120
8 X 4	XDMJFT0804P401		1,677.00	159
8 X 6	XDMJFT0806P401	2	1,690.00	170
8 X 8	XDMJFT0808P401	2	2,001.00	194
10 X 4	XDMJFT1004P401		2,422.00	229
10 X 6	XDMJFT1006P401	12	2,361.00	245
10 X 8	XDMJFT1008P401		2,591.00	250
12 X 4	XDMJFT1204P401	2	3,287.00	323
12 X 6	XDMJFT1206P401	2	3,128.00	320
12 X 8	XDMJFT1208P401	2	3,251.00	342
12 X 10	XDMJFT1210P401		POA	372
12 X 12	XDMJFT1212P401		3,815.00	401
14 X 6	XDMJFT1406P401		POA	457
14 X 8	XDMJFT1408P401		POA	473
16 X 4	XDMJFT1604P401		6,226.00	575
16 X 6	XDMJFT1606P401		6,511.00	605
16 X 8	XDMJFT1608P401		6,607.00	615
16 X 12	XDMJFT1612P401		6,949.00	651
16 X 16	XDMJFT1616P401		7,697.00	730
18 X 6	XDMJFT1806P401		7,177.00	665
18 X 8	XDMJFT1808P401		7,271.00	675
18 X 12	XDMJFT1812P401		7,556.00	735
18 X 18	XDMJFT1818P401		9,553.00	915
20 X 6	XDMJFT2006P401		POA	820
20 X 8	XDMJFT2008P401		8,885.00	835
20 X 12	XDMJFT2012P401		POA	700
20 X 20	XDMJFT2020P401		12,022.00	1165
24 X 6	XDMJFT2406P401		11,832.00	1125
24 X 8	XDMJFT2408P401		11,971.00	1140
24 X 12	XDMJFT2412P401		12,212.00	1165
24 X 18	XDMJFT2418P401		POA	1349
24 X 24	XDMJFT2424P401		18,196.00	1795
30 X 6	XDMJFT3006P401		27,157.00	1800

Size (in)	Item No.	Crt. Qty.	List Price (\$)	Wt. (lb.)
30 X 8	XDMJFT3008P401		POA	1725
30 X 30	XDMJFT3030P401		POA	3080
36 X 6	XDMJFT3606P401		POA	2430
36 X 8	XDMJFT3608P401		POA	
36 X 12	XDMJFT3612P401		36,647.00	2550
36 X 16	XDMJFT3616P401		26,729.00	2450
36 X 24	XDMJFT3624P401		29,598.00	2660
36 X 30	XDMJFT3630P401		POA	2964
36 X 36	XDMJFT3636P401		POA	3461
42 X 12	XDMJFT4212P401		POA	3547
42 X 16	XDMJFT4216P401		POA	3562
42 X 24	XDMJFT4224P401		POA	3527
48 X 24	XDMJFT4824P401		POA	4965

CROSSES : MJ X FE

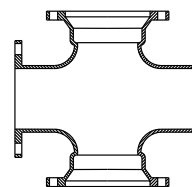

Size (in)	Item No.	Crt. Qty.	List Price (\$)	Wt. (lb.)
6 X 6	XDMJFX0606P401	0	POA	140
8 X 6	XDMJFX0806P401	0	POA	185
8 X 8	XDMJFX0808P401	0	POA	240
10 X 10	XDMJFX1010P401	0	POA	354
12 X 6	XDMJFX1206P401	0	POA	340
12 X 8	XDMJFX1208P401	0	POA	365
12 X 12	XDMJFX1212P401	0	POA	487
16 X 8	XDMJFX1608P401	0	POA	655
16 X 16	XDMJFX1616P401	0	POA	875

P401 P401 P401 P401 P401 P401 P401 P401 P401 P401 P401 P401

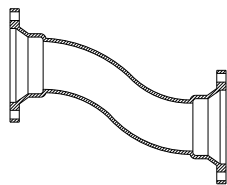
MJ OFFSET

Size (in)	Item No.	Crt. Qty.	List Price (\$)	Wt. (lb.)
4 X 6	XDMJO0406P401	0	POA	75
4 X 12	XDMJO0412P401	0	POA	85
4 X 18	XDMJO0418P401	0	POA	105
4 X 24	XDMJO0424P401	0	POA	126
6 X 6	XDMJO0606P401	0	POA	114
6 X 12	XDMJO0612P401	0	POA	135
6 X 18	XDMJO0618P401	0	POA	188
6 X 24	XDMJO0624P401	0	POA	182
8 X 6	XDMJO0806P401	0	POA	177
8 X 12	XDMJO0812P401	0	POA	231
8 X 18	XDMJO0818P401	0	POA	287
8 X 24	XDMJO0824P401	0	POA	280
10 X 12	XDMJO1012P401	0	POA	347
10 X 18	XDMJO1018P401	0	POA	340
10 X 24	XDMJO1024P401	0	POA	420
12 X 6	XDMJO1206P401	0	POA	345
12 X 12	XDMJO1212P401	0	POA	420
12 X 18	XDMJO1218P401	0	POA	520
12 X 24	XDMJO1224P401	0	POA	649
16 X 12	XDMJO1612P401	0	POA	715
16 X 18	XDMJO1618P401	0	POA	850
20 X 12	XDMJO2012P401	0	POA	1025
20 X 18	XDMJO2018P401	0	POA	1246
20 X 24	XDMJO2024P401	0	POA	1362

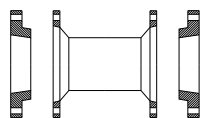
MJ DUAL PURPOSE SLEEVES

Size (in)	Item No.	Crt. Qty.	List Price (\$)	Wt. (lb.)
4	XDMJSSDP04P401	24	POA	35
6	XDMJSSDP06P401	18	POA	45
8	XDMJSSDP08P401	0	POA	65

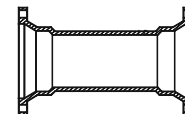
MJ LONG SLEEVES

Size (in)	Item No.	Crt. Qty.	List Price (\$)	Wt. (lb.)
2	XDMJSL02P401	0	POA	18
3	XDMJSL03P401	0	509.00	30
4	XDMJSL04P401	24	509.00	45
6	XDMJSL06P401	27	747.00	65
8	XDMJSL08P401	27	951.00	85
10	XDMJSL10P401	12	1,454.00	115
12	XDMJSL08P401	12	1,671.00	145
14	XDMJSL12P401	2	2,451.00	195
16	XDMJSL16P401	2	2,772.00	235
18	XDMJSL18P401	0	3,643.00	285
20	XDMJSL20P401	2	3,776.00	325
24	XDMJSL24P401	0	4,865.00	425
30	XDMJSL30P401	0	10,164.00	1088
36	XDMJSL36P401	0	13,515.00	1052
42	XDMJSL42P401	0	POA	1550
48	XDMJSL48P401	0	POA	1940

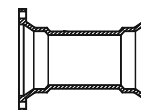
MJ SHORT SLEEVES

Size (in)	Item No.	Crt. Qty.	List Price (\$)	Wt. (lb.)
2	XDMJSS02P401	48	POA	12
3	XDMJSS03P401		POA	25
4	XDMJSS04P401	4	478.00	35
6	XDMJSS06P401	4	608.00	45
8	XDMJSS08P401	27	845.00	65
10	XDMJSS10P401	4	1,177.00	85
12	XDMJSS12P401	12	1,493.00	110
14	XDMJSS14P401		2,602.00	150
16	XDMJSS16P401		2,237.00	180
18	XDMJSS18P401		2,825.00	215
20	XDMJSS20P401		3,150.00	240
24	XDMJSS24P401		4,531.00	320
30	XDMJSS30P401		8,807.00	635
36	XDMJSS36P401		11,784.00	855
42	XDMJSS42P401		POA	1115
48	XDMJSS48P401		POA	1385

REDUCERS : MJ X MJ

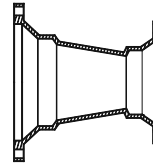

Size (in)	Item No.	Crt. Qty.	List Price (\$)	Wt. (lb.)
3 X 2	XDMJR0302P401	60	POA	26
4 X 2	XDMJR0402P401	48	POA	30
4 X 3	XDMJR0403P401	48	517.00	40
6 X 2	XDMJR0602P401	24	POA	45
6 X 3	XDMJR0603P401	24	734.00	55
6 X 4	XDMJR0604P401	24	712.00	60
8 X 3	XDMJR0803P401		POA	84
8 X 4	XDMJR0804P401	16	1,083.00	80
8 X 6	XDMJR0806P401	16	1,055.00	95
10 X 4	XDMJR1004P401		1,419.00	105
10 X 6	XDMJR1006P401	12	1,425.00	115
10 X 8	XDMJR1008P401	12	1,590.00	135
12 X 4	XDMJR1204P401	8	1,778.00	135
12 X 6	XDMJR1206P401	8	2,077.00	150
12 X 8	XDMJR1208P401	8	1,953.00	165
12 X 10	XDMJR1210P401	8	2,161.00	190
14 X 6	XDMJR1406P401	4	2,406.00	190
14 X 8	XDMJR1408P401		2,295.00	214
14 X 10	XDMJR1410P401		2,512.00	236
14 X 12	XDMJR1412P401	2	3,000.00	255
16 X 6	XDMJR1606P401		2,868.00	230
16 X 8	XDMJR1608P401		3,520.00	250
16 X 10	XDMJR1610P401		3,270.00	280
16 X 12	XDMJR1612P401		3,891.00	305
16 X 14	XDMJR1614P401		3,826.00	335
18 X 8	XDMJR1808P401		3,555.00	295
18 X 10	XDMJR1810P401		3,827.00	325
18 X 12	XDMJR1812P401		4,055.00	350
18 X 14	XDMJR1814P401		4,329.00	380
18 X 16	XDMJR1816P401		4,649.00	415
20 X 8	XDMJR2008P401		POA	345
20 X 10	XDMJR2010P401		4,331.00	375
20 X 12	XDMJR2012P401		4,655.00	405
20 X 14	XDMJR2014P401		6,452.00	435
20 X 16	XDMJR2016P401		5,245.00	470
20 X 18	XDMJR2018P401		5,612.00	510
24 X 12	XDMJR2412P401		6,166.00	550
24 X 16	XDMJR2416P401		6,761.00	615
24 X 18	XDMJR2418P401		7,170.00	660

Size (in)	Item No.	Crt. Qty.	List Price (\$)	Wt. (lb.)
24 X 20	XDMJR2420P401		7,581.00	705
30 X 12	XDMJR3012P401		9,941.00	920
30 X 16	XDMJR3016P401		11,063.00	985
30 X 18	XDMJR3018P401		11,112.00	990
30 X 20	XDMJR3020P401		11,698.00	1050
30 X 24	XDMJR3024P401		12,822.00	1165
36 X 20	XDMJR3620P401		15,895.00	1450
36 X 24	XDMJR3624P401		17,164.00	1580
36 X 30	XDMJR3630P401		19,851.00	1855
42 X 20	XDMJR4220P401		POA	1928
42 X 24	XDMJR4224P401		24,363.00	2060
42 X 30	XDMJR4230P401		27,727.00	2370
42 X 36	XDMJR4236P401		30,762.00	2714
48 X 30	XDMJR4830P401		34,909.00	3005
48 X 36	XDMJR4836P401		38,689.00	3385
48 X 42	XDMJR4842P401		43,050.00	3776

REDUCERS : FE X MJ

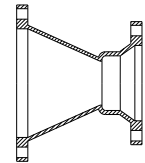

Size (in)	Item No.	Crt. Qty.	List Price (\$)	Wt. (lb.)
4 X 3	FXDMJR0403P401	0	POA	34
6 X 4	FXDMJR0604P401	0	POA	60
8 X 4	FXDMJR0804P401	0	POA	80
8 X 6	FXDMJR0806P401	0	POA	89
10 X 6	FXDMJR1006P401	0	POA	114
10 X 8	FXDMJR1008P401	0	POA	130
12 X 6	FXDMJR1206P401	0	POA	151
12 X 8	FXDMJR1208P401	0	POA	183
12 X 10	FXDMJR1210P401	0	POA	190
16 X 12	FXDMJR1612P401	0	POA	305

P401 P401 P401 P401 P401 P401 P401 P401 P401 P401

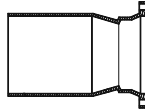
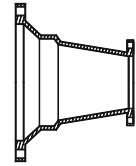
**REDUCERS : MJ
SMALL END (SEB)**

REDUCERS : MJ X FE

Size (in)	Item No.	Crt. Qty.	List Price (\$)	Wt. (lb.)
3 X 2	XDMJRS0302P401	48	POA	14
4 X 2	XDMJRS0402P401	48	POA	18
4 X 3	XDMJRS0403P401		503.00	35
6 X 2	XDMJRS0602P401	26	POA	45
6 X 3	XDMJRS0603P401		732.00	50
6 X 4	XDMJRS0604P401		817.00	60
8 X 3	XDMJRS0803P401		POA	77
8 X 4	XDMJRS0804P401	16	1,091.00	80
8 X 6	XDMJRS0806P401	16	1,180.00	90
10 X 6	XDMJRS1006P401		1,492.00	115
10 X 8	XDMJRS1008P401		1,625.00	130
12 X 4	XDMJRS1204P401		1,720.00	130
12 X 6	XDMJRS1206P401		1,898.00	150
12 X 8	XDMJRS1208P401	12	2,031.00	165
12 X 10	XDMJRS1210P401		2,252.00	190
16 X 8	XDMJRS1608P401		2,948.00	230
16 X 12	XDMJRS1612P401		3,470.00	285
16 X 14	XDMJRS1614P401		6,152.00	310
18 X 12	XDMJRS1812P401		3,948.00	325
20 X 8	XDMJRS2008P401		7,466.00	345
20 X 12	XDMJRS2012P401		4,515.00	375
20 X 16	XDMJRS2016P401		5,087.00	435
20 X 18	XDMJRS2018P401		POA	345
24 X 12	XDMJRS2412P401		5,990.00	510
24 X 14	XDMJRS2414P401		8,579.00	535
24 X 16	XDMJRS2416P401		9,647.00	575
24 X 18	XDMJRS2418P401		6,607.00	620
24 X 20	XDMJRS2420P401		7,035.00	665
30 X 16	XDMJRS3016P401		10,589.00	900
30 X 18	XDMJRS3018P401		10,437.00	885
30 X 20	XDMJRS3020P401		11,047.00	945
30 X 24	XDMJRS3024P401		12,216.00	1060
36 X 20	XDMJRS3620P401		23,566.00	1285
36 X 24	XDMJRS3624P401		26,710.00	1410
36 X 30	XDMJRS3630P401		18,916.00	1690
42 X 30	XDMJRS4230P401		POA	2165
42 X 36	XDMJRS4236P401		POA	2485
48 X 36	XDMJRS4836P401		POA	3100

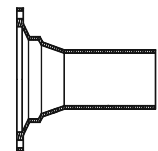
Size (in)	Item No.	Crt. Qty.	List Price (\$)	Wt. (lb.)
4 X 3	XDMJFR0403P401	0	POA	35
6 X 3	XDMJFR0603P401	0	POA	49
6 X 4	XDMJFR0604P401	0	POA	54
8 X 4	XDMJFR0804P401	0	POA	75
8 X 6	XDMJFR0806P401	2	POA	80
10 X 6	XDMJFR1006P401	0	POA	105
10 X 8	XDMJFR1008P401	0	POA	130
12 X 6	XDMJFR1206P401	0	POA	145
12 X 8	XDMJFR1208P401	0	POA	175
12 X 10	XDMJFR1210P401	0	POA	185
14 X 6	XDMJFR1406P401	0	POA	195
14 X 8	XDMJFR1408P401	0	POA	215
14 X 12	XDMJFR1412P401	0	POA	270
16 X 12	XDMJFR1612P401	0	POA	325
18 X 8	XDMJFR1808P401	0	POA	300
18 X 12	XDMJFR1812P401	0	POA	360
18 X 16	XDMJFR1816P401	0	POA	445
20 X 16	XDMJFR2016P401	0	POA	510
24 X 12	XDMJFR2412P401	0	POA	455

**REDUCERS : MJ
LARGE END (LEB)**

Size (in)	Item No.	Crt. Qty.	List Price (\$)	Wt. (lb.)
4 X 3	XDMJRL0403P401		POA	40
6 X 3	XDMJRL0603P401		POA	55
6 X 4	XDMJRL0604P401		817.00	60
8 X 3	XDMJRL0803P401		1,058.00	70
8 X 4	XDMJRL0804P401		1,091.00	80
8 X 6	XDMJRL0806P401		1,249.00	98
10 X 6	XDMJRL1006P401		1,492.00	115
10 X 8	XDMJRL1008P401		1,625.00	130
12 X 4	XDMJRL1204P401		POA	135
12 X 6	XDMJRL1206P401		1,855.00	145
12 X 8	XDMJRL1208P401		2,031.00	165
12 X 10	XDMJRL1210P401		2,210.00	185

Contd.....

**REDUCERS : MJ
LARGE END (LEB)**

Contd.....

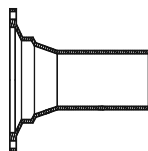

Size (in)	Item No.	Crt. Qty.	List Price (\$)	Wt. (lb.)
16 X 8	XDMJRL1608P401		POA	
16 X 10	XDMJRL1610P401		POA	
16 X 12	XDMJRL1612P401		3,662.00	305
20 X 10	XDMJRL2010P401		5,630.00	375
20 X 16	XDMJRL2016P401		5,180.00	445
24 X 16	XDMJRL2416P401		6,795.00	595
24 X 20	XDMJRL2420P401		7,556.00	675
30 X 16	XDMJRL3016P401		15,039.00	910
30 X 18	XDMJRL3018P401		15,200.00	965
30 X 20	XDMJRL3020P401		10,914.00	1020
30 X 24	XDMJRL3024P401		12,881.00	1125
36 X 20	XDMJRL3620P401		16,164.00	1420
36 X 24	XDMJRL3624P401		17,339.00	1535
36 X 30	XDMJRL3630P401		17,672.00	1750
42 X 30	XDMJRL4230P401		POA	2265
42 X 36	XDMJRL4236P401		POA	2530
48 X 42	XDMJRL4842P401		POA	3540

ADAPTERS : MJ X FLANGE

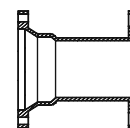

Size (in)	Item No.	Crt. Qty.	List Price (\$)	Wt. (lb.)
3	XDMJFA03P401		605.00	30
4	XDMJFA04P401	16	798.00	40
6	XDMJFA06P401	8	1,107.00	60
8	XDMJFA08P401	8	1,137.00	85
10	XDMJFA10P401		2,057.00	115
12	XDMJFA12P401		2,120.00	155
14	XDMJFA14P401	4	3,141.00	195
16	XDMJFA16P401		3,313.00	240
18	XDMJFA18P401		3,396.00	280
20	XDMJFA20P401		4,563.00	340
24	XDMJFA24P401		5,492.00	455
30	XDMJFA30P401		9,163.00	760
36	XDMJFA36P401		POA	1070
42	XDMJFA42P401		POA	1505
48	XDMJFA48P401		POA	1942

**HYDRANT ADAPTERS :
SWIVEL X SOLID
WITH SWIVEL GLAND
(ANCHOR COUPLING)**

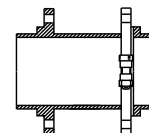

**HYDRANT ELL :
SWIVEL X SWIVEL
WITH TWO-SWIVEL GLAND**

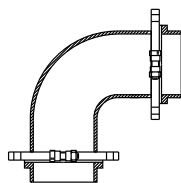

Size (in)	Item No.	Crt. Qty.	List Price (\$)	Wt. (lb.)
6	XDMJHB9006P401	0	POA	87
8	XDMJHB9008P401	0	POA	158

Size (in)	Item No.	Crt. Qty.	List Price (\$)	Wt. (lb.)
4 X 13	XDMJHA0413P401	60	POA	28
6 X 13	XDMJHA0613P401		POA	54
6 X 18	XDMJHA0618P401		POA	68
6 X 24	XDMJHA0624P401		POA	81
6 X 36	XDMJHA0636P401		POA	110
6 X 48	XDMJHA0648P401		POA	139
8 X 13	XDMJHA0813P401	27	POA	68
8 X 18	XDMJHA0818P401		POA	88
8 X 24	XDMJHA0824P401		POA	112
8 X 48	XDMJHA0848P401		POA	208
12 X 13	XDMJHA1213P401	12	POA	123

P401 P401 P401 P401 P401 P401 P401 P401 P401 P401

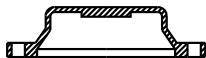
MJ CAPS : SOLID

Size (in)	Item No.	Crt. Qty.	List Price (\$)	Wt. (lb.)
2	XDMJC02P401	100	POA	5
3	XDMJC03P401	50	316.00	12
4	XDMJC04P401	18	316.00	20
6	XDMJC06P401	18	466.00	30
8	XDMJC08P401	18	702.00	45
10	XDMJC10P401	8	972.00	60
12	XDMJC12P401	8	1,242.00	80
14	XDMJC14P401	2	POA	110
16	XDMJC16P401	2	2,138.00	155
18	XDMJC18P401	2	2,437.00	185
20	XDMJC20P401	2	3,117.00	200
24	XDMJC24P401	2	4,297.00	300
30	XDMJC30P401	0	7,203.00	590
36	XDMJC36P401	0	10,030.00	815
42	XDMJC42P401	0	14,810.00	1180
48	XDMJC48P401	0	19,601.00	1595

MJ CAPS : 2" TAPPED

Size (in)	Item No.	Crt. Qty.	List Price (\$)	Wt. (lb.)
2	XDMJC02TP401	0	POA	5
3	XDMJC03TP401	0	380.00	12
4	XDMJC04TP401	0	450.00	20
6	XDMJC06TP401	18	633.00	30
8	XDMJC08TP401	18	916.00	45
10	XDMJC10TP401	0	1,235.00	60
12	XDMJC12TP401	8	1,439.00	80
14	XDMJC14TP401	0	POA	110
16	XDMJC16TP401	0	2,241.00	155
18	XDMJC18TP401	0	2,566.00	185
20	XDMJC20TP401	0	3,249.00	200
24	XDMJC24TP401	0	4,427.00	300
30	XDMJC30TP401	0	7,659.00	590
36	XDMJC36TP401	0	10,487.00	815
42	XDMJC42TP401	0	14,942.00	1180
48	XDMJC48TP401	0	19,731.00	1595

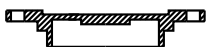
MJ PLUGS : SOLID

Size (in)	Item No.	Crt. Qty.	List Price (\$)	Wt. (lb.)
2	XDMJP02P401	24	POA	5
3	XDMJP03P401	0	316.00	10
4	XDMJP04P401	18	316.00	20
6	XDMJP06P401	18	491.00	30
8	XDMJP08P401	12	750.00	50
10	XDMJP10P401	8	1,012.00	65
12	XDMJP12P401	8	1,285.00	85
14	XDMJP14P401	0	1,721.00	115
16	XDMJP16P401	2	2,060.00	145
18	XDMJP18P401	0	1,953.00	180
20	XDMJP20P401	0	3,117.00	200
24	XDMJP24P401	0	4,205.00	290
30	XDMJP30P401	0	7,057.00	575
36	XDMJP36P401	0	9,690.00	815
42	XDMJP42P401	0	14,049.00	1110
48	XDMJP48P401	0	18,079.00	1455

MJ PLUGS : 2" TAPPED

Size (in)	Item No.	Crt. Qty.	List Price (\$)	Wt. (lb.)
3	XDMJP03TP401	0	363.00	10
4	XDMJP04TP401	18	450.00	20
6	XDMJP06TP401	120	632.00	30
8	XDMJP08TP401	100	893.00	50
10	XDMJP10TP401	8	1,166.00	65
12	XDMJP12TP401	40	1,443.00	85
14	XDMJP14TP401	0	1,895.00	115
16	XDMJP16TP401	0	2,241.00	145
18	XDMJP18TP401	0	2,123.00	180
20	XDMJP20TP401	0	3,335.00	200
24	XDMJP24TP401	0	4,455.00	290
30	XDMJP30TP401	0	7,412.00	575
36	XDMJP36TP401	0	10,140.00	815
42	XDMJP42TP401	0	14,178.00	1110
48	XDMJP48TP401	0	18,211.00	1455

Utility Pipe Fittings P401 Lined

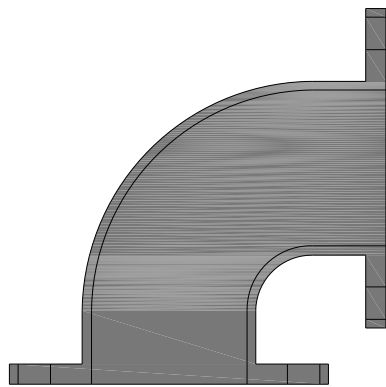

ANSI/AWWA C110/A21.10
FLANGE FITTINGS
P401 LINED

PRICE LIST

Effective January 14, 2019.



90° LONG RADIUS BENDS

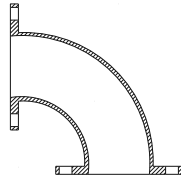

Size (in)	Item No.	List Price (\$)	Wt. (lb.)
3	DFBLR9003P401	484.00	30
4	DFBLR9004P401	704.00	30
6	DFBLR9006P401	1,140.00	80
8	DFBLR9008P401	1,902.00	140
10	DFBLR9010P401	2,664.00	215
12	DFBLR9012P401	4,058.00	325
14	DFBLR9014P401	4,165.00	580
16	DFBLR9016P401	6,917.00	740
18	DFBLR9018P401	7,515.00	840
20	DFBLR9020P401	9,762.00	928
24	DFBLR9024P401	13,904.00	1640
30	DFBLR9030P401	24,307.00	2105
36	DFBLR9036P401	36,745.00	3285
42	DFBLR9042P401	61,874.00	4865
48	DFBLR9048P401	85,172.00	7800
54	DFBLR9054P401	POA	6205

90° FLANGE X FLARE BENDS

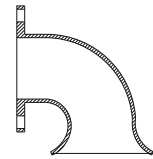

Size (in)	Item No.	List Price (\$)	Wt. (lb.)
3	DFF9003P401	506.00	25
4	DFF9004P401	582.00	40
6	DFF9006P401	893.00	70
8	DFF9008P401	1,410.00	110
10	DFF9010P401	2,129.00	175
12	DFF9012P401	2,646.00	245
14	DFF9014P401	3,531.00	340
16	DFF9016P401	4,619.00	460
18	DFF9018P401	5,547.00	560
20	DFF9020P401	7,242.00	700
24	DFF9024P401	10,061.00	1100
30	DFF9030P401	20,238.00	1840
36	DFF9036P401	27,749.00	2700
42	DFF9042P401	34,534.00	3250
48	DFF9048P401	55,405.00	4215
54	DFF9054P401	POA	3965

STRAIGHT FLANGE X FLARE

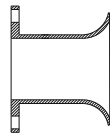

Size (in)	Item No.	List Price (\$)	Wt. (lb.)
3	DFP03P401	POA	20
4	DFP04P401	460.00	30
6	DFP06P401	645.00	40
8	DFP08P401	1,001.00	70
10	DFP10P401	1,308.00	95
12	DFP12P401	1,907.00	115
14	DFP14P401	2,097.00	190
16	DFP16P401	2,813.00	330
18	DFP18P401	3,208.00	355
20	DFP20P401	4,204.00	460
24	DFP24P401	5,509.00	635
30	DFP30P401	12,251.00	1025
36	DFP36P401	POA	1460
42	DFP42P401	POA	1900
48	DFP48P401	POA	2350
54	DFP54P401	POA	2035

LONG RADIUS 90° FLANGE X FLARE BENDS

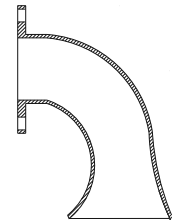

Size (in)	Item No.	List Price (\$)	Wt. (lb.)
3	DFFLR9003P401	POA	30
4	DFFLR9004P401	POA	50
6	DFFLR9006P401	1,646.00	90
8	DFFLR9008P401	2,656.00	115
10	DFFLR9010P401	4,074.00	250
12	DFFLR9012P401	5,891.00	375
14	DFFLR9014P401	7,706.00	500
16	DFFLR9016P401	10,734.00	715
18	DFFLR9018P401	12,016.00	800
20	DFFLR9020P401	17,889.00	1140
24	DFFLR9024P401	20,993.00	1335
30	DFFLR9030P401	36,018.00	2190
36	DFFLR9036P401	56,154.00	3465
42	DFFLR9042P401	55,704.00	5150
48	DFFLR9048P401	72,292.00	6725

P401 P401 P401 P401 P401 P401 P401 P401 P401 P401

90° BASE BENDS

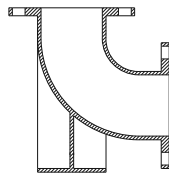

Size (in)	Item No.	List Price (\$)	Wt. (lb.)
3	DFBB9003P401	664.00	35
4	DFBB9004P401	664.00	55
6	DFBB9006P401	957.00	85
8	DFBB9008P401	1,670.00	145
10	DFBB9010P401	2,252.00	210
12	DFBB9012P401	3,086.00	300
14	DFBB9014P401	3,695.00	320
16	DFBB9016P401	4,497.00	445
18	DFBB9018P401	5,590.00	565
20	DFBB9020P401	7,242.00	700
24	DFBB9024P401	10,369.00	1030
30	DFBB9030P401	16,969.00	1625
36	DFBB9036P401	24,482.00	2385
42	DFBB9042P401	43,886.00	3465
48	DFBB9048P401	49,091.00	4610
54	DFBB9054P401	POA	4415

90° LONG RADIUS BASE BENDS

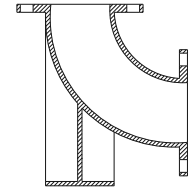

Size (in)	Item No.	List Price (\$)	Wt. (lb.)
3	DFBBLR9003P401	484.00	40
4	DFBBLR9004P401	704.00	60
6	DFBBLR9006P401	1,140.00	100
8	DFBBLR9008P401	1,902.00	180
10	DFBBLR9010P401	2,664.00	260
12	DFBBLR9012P401	4,058.00	390
14	DFBBLR9014P401	4,165.00	650
16	DFBBLR9016P401	6,917.00	815
18	DFBBLR9018P401	7,515.00	955
20	DFBBLR9020P401	9,762.00	1200
24	DFBBLR9024P401	13,904.00	1770
30	DFBBLR9030P401	24,307.00	2295
36	DFBBLR9036P401	36,745.00	3535
42	DFBBLR9042P401	61,874.00	5275
48	DFBBLR9048P401	85,172.00	7305
54	DFBBLR9054P401	POA	6880

BASE TEES

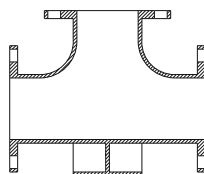

Size (in)	Item No.	List Price (\$)	Wt. (lb.)
3	DFTB0303P401	544.00	45
4	DFTB0404P401	829.00	75
6	DFTB0606P401	1,225.00	110
8	DFTB0808P401	1,945.00	185
10	DFTB1010P401	2,990.00	300
12	DFTB1212P401	4,165.00	430
14	DFTB1414P401	4,723.00	500
16	DFTB1616P401	5,768.00	600
18	DFTB1818P401	7,022.00	740
20	DFTB2020P401	9,276.00	930
24	DFTB2424P401	13,728.00	1410
30	DFTB3030P401	23,077.00	2270
36	DFTB3636P401	33,334.00	3320
42	DFTB4242P401	65,509.00	5850
48	DFTB4848P401	86,096.00	7720
54	DFTB5454P401	POA	6465

P 4 0 1 P 4 0 1 P 4 0 1 P 4 0 1 P 4 0 1 P 4 0 1 P 4 0 1 P 4 0 1 P 4 0 1 P 4 0 1

FLANGE TEES

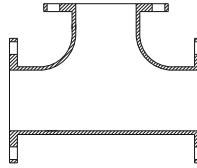

Size (in)	Item No.	List Price (\$)	Wt. (lb.)
2 X 2	DFT0202P401	POA	20
3 X 2	DFT0302P401	POA	35
3 X 3	DFT0303P401	747.00	40
4 X 2	DFT0402P401	POA	50
4 X 3	DFT0403P401	722.00	60
4 X 4	DFT0404P401	747.00	65
5 X 5	DFT0505P401	POA	80
6 X 2	DFT0602P401	POA	156
6 X 3	DFT0603P401	1,041.00	85
6 X 4	DFT0604P401	1,058.00	90
6 X 6	DFT0606P401	985.00	95
8 X 3	DFT0803P401	1,600.00	130
8 X 4	DFT0804P401	1,461.00	140
8 X 6	DFT0806P401	1,391.00	145
8 X 8	DFT0808P401	1,540.00	155
10X 4	DFT1004P401	2,021.00	205
10X 6	DFT1006P401	1,918.00	215
10X 8	DFT1008P401	1,989.00	225
10X10	DFT1010P401	2,226.00	270
12X 4	DFT1204P401	2,664.00	290
12X 6	DFT1206P401	2,583.00	295
12X 8	DFT1208P401	2,688.00	310
12X10	DFT1210P401	3,085.00	360
12X12	DFT1212P401	3,105.00	385
14X 4	DFT1404P401	3,965.00	370
14X 6	DFT1406P401	3,817.00	375
14X 8	DFT1408P401	3,942.00	390
14X10	DFT1410P401	4,024.00	400
14X12	DFT1412P401	4,230.00	425
14X14	DFT1414P401	4,310.00	435
16X 4	DFT1604P401	4,821.00	460
16X 6	DFT1606P401	3,942.00	465
16X 8	DFT1608P401	4,018.00	475
16X10	DFT1610P401	4,872.00	495
16X12	DFT1612P401	4,268.00	520
16X14	DFT1614P401	5,195.00	530
16X16	DFT1616P401	4,548.00	550
18X 6	DFT1806P401	4,410.00	480
18X 8	DFT1808P401	5,264.00	495
18X10	DFT1810P401	5,139.00	510

Size (in)	Item No.	List Price (\$)	Wt. (lb.)
18X12	DFT1812P401	4,790.00	535
18X14	DFT1814P401	6,039.00	630
18X16	DFT1816P401	6,286.00	650
18X18	DFT1818P401	5,725.00	785
20X 6	DFT2006P401	6,448.00	610
20X 8	DFT2008P401	6,536.00	620
20X10	DFT2010P401	6,669.00	635
20X12	DFT2012P401	6,891.00	660
20X14	DFT2014P401	6,935.00	665
20X16	DFT2016P401	8,216.00	810
20X18	DFT2018P401	8,303.00	820
20X20	DFT2020P401	7,199.00	855
24X 4	DFT2404P401	POA	
24X 6	DFT2406P401	7,498.00	845
24X 8	DFT2408P401	8,866.00	860
24X10	DFT2410P401	9,042.00	880
24X12	DFT2412P401	7,787.00	890
24X14	DFT2414P401	9,160.00	900
24X16	DFT2416P401	7,950.00	915
24X18	DFT2418P401	12,048.00	1220
24X20	DFT2420P401	12,360.00	1510
24X24	DFT2424P401	11,016.00	1330
30X 6	DFT3006P401	15,362.00	1450
30X 8	DFT3008P401	15,408.00	
30X10	DFT3010P401	15,693.00	
30X12	DFT3012P401	15,693.00	1490
30X14	DFT3014P401	15,693.00	1490
30X16	DFT3016P401	15,834.00	1505
30X18	DFT3018P401	16,850.00	1515
30X20	DFT3020P401	16,163.00	1540
30X24	DFT3024P401	20,757.00	2025
30X30	DFT3030P401	18,428.00	2150
36X10	DFT3610P401	POA	3082
36X12	DFT3612P401	22,447.00	2170
36X14	DFT3614P401	22,494.00	2175
36X16	DFT3616P401	22,589.00	2185
36X18	DFT3618P401	22,637.00	2190
36X20	DFT3620P401	22,825.00	2210
36X24	DFT3624P401	23,253.00	2255

Contd.....

P 4 0 1 P 4 0 1 P 4 0 1 P 4 0 1 P 4 0 1 P 4 0 1 P 4 0 1 P 4 0 1 P 4 0 1 P 4 0 1 P 4 0 1 P 4 0 1

FLANGE TEES

Contd.....

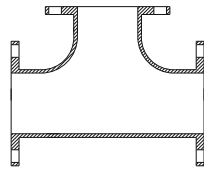

Size (in)	Item No.	List Price (\$)	Wt. (lb.)
36X30	DFT3630P401	30,304.00	3000
36X36	DFT3636P401	26,507.00	3160
42X12	DFT4212P401	34,181.00	3165
42X14	DFT4214P401	34,234.00	3170
42X16	DFT4216P401	34,331.00	3180
42X18	DFT4218P401	34,382.00	3185
42X20	DFT4220P401	34,584.00	3205
42X24	DFT4224P401	34,988.00	3245
42X30	DFT4230P401	43,877.00	4125
42X36	DFT4236P401	56,351.00	5360
42X42	DFT4242P401	58,575.00	5580
48X12	DFT4812P401	46,114.00	4315
48X14	DFT4814P401	46,114.00	4315
48X16	DFT4816P401	46,262.00	4330
48X18	DFT4818P401	46,262.00	4330
48X20	DFT4820P401	46,464.00	4350
48X24	DFT4824P401	46,821.00	4385
48X30	DFT4830P401	47,527.00	4455
48X36	DFT4836P401	58,638.00	7035
48X42	DFT4842P401	75,203.00	7195
48X48	DFT4848P401	77,121.00	7385
54X12	DFT5412P401	POA	4435
54X14	DFT5414P401	POA	4435
54X16	DFT5416P401	POA	4450
54X18	DFT5418P401	POA	4460
54X20	DFT5420P401	POA	4480
54X24	DFT5424P401	POA	4515
54X30	DFT5430P401	POA	4615
54X36	DFT5436P401	POA	4695
54X42	DFT5442P401	POA	5740
54X48	DFT5448P401	POA	5850
54X54	DFT5454P401	POA	6025

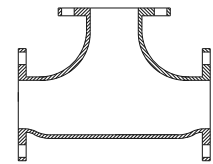
FLANGE TEES - BULL HEAD

Size (in)	Item No.	List Price (\$)	Wt. (lb.)
4 X 4 X 6	DFTBH040406P401	POA	90
6 X 6 X 8	DFTBH060608P401	POA	140
8 X 6 X 4	DFTBH080604P401	POA	146
8 X 8 X 10	DFTBH080810P401	POA	260
8 X 8 X 12	DFTBH080812P401	POA	291
10X10X12	DFTBH101012P401	POA	355

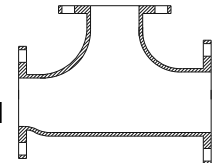
FLANGE TEES - REDUCING ON THE RUN

Size (in)	Item No.	List Price (\$)	Wt. (lb.)
4 X 3 X 3	DFTROR040303P401	POA	55
6 X 4 X 4	DFTROR060404P401	POA	103
6 X 4 X 6	DFTROR060406P401	POA	108
8 X 6 X 4	DFTROR080604P401	POA	146
8 X 6 X 6	DFTROR080606P401	POA	148
8 X 6 X 8	DFTROR080608P401	POA	145
10X 6 X 6	DFTROR100606P401	POA	275
10X 6 X 10	DFTROR100610P401	POA	305
10X 8 X 6	DFTROR100806P401	POA	280
10X 8 X 8	DFTROR100808P401	POA	302
10X 8 X 10	DFTROR100810P401	POA	325
12X 6 X 6	DFTROR120606P401	POA	340
12X 6 X 8	DFTROR120608P401	POA	360
12X 8 X 6	DFTROR120806P401	POA	355
12X 8 X 8	DFTROR120808P401	POA	375
12X 8 X 12	DFTROR120812P401	POA	420
12X10X 6	DFTROR121006P401	POA	390
12X10X 8	DFTROR121008P401	POA	400
12X10X10	DFTROR121010P401	POA	420
12X10X12	DFTROR121012P401	POA	440

FLANGE LATERAL WYES

Contd.....

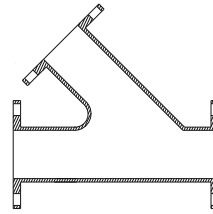

Size (in)	Item No.	List Price (\$)	Wt. (lb.)
18X14	DFY1814P401	8,952.00	885
18X16	DFY1816P401	9,363.00	935
18X18	DFY1818P401	8,992.00	1035
20X 8	DFY2008P401	POA	740
20X10	DFY2010P401	8,172.00	1025
20X12	DFY2012P401	10,867.00	1065
20X14	DFY2014P401	11,794.00	1110
20X16	DFY2016P401	12,281.00	1155
20X18	DFY2018P401	12,318.00	1200
20X20	DFY2020P401	12,237.00	1265
24X 6	DFY2406P401	POA	
24X 8	DFY2408P401	POA	1425
24X10	DFY2410P401	POA	1460
24X12	DFY2412P401	11,872.00	1550
24X14	DFY2414P401	12,873.00	1560
24X16	DFY2416P401	17,969.00	1615
24X18	DFY2418P401	17,076.00	1680
24X20	DFY2420P401	17,538.00	1750
24X24	DFY2424P401	18,103.00	1905
30X12	DFY3012P401	30,620.00	2545
30X14	DFY3014P401	30,620.00	2590
30X16	DFY3016P401	30,997.00	2645
30X18	DFY3018P401	31,183.00	2690
30X20	DFY3020P401	31,658.00	2760
30X24	DFY3024P401	31,931.00	2915
30X30	DFY3030P401	32,122.00	3225
36X12	DFY3612P401	46,716.00	4490
36X14	DFY3614P401	46,815.00	4545
36X16	DFY3616P401	47,057.00	4000
36X18	DFY3618P401	47,120.00	4670

Size (in)	Item No.	List Price (\$)	Wt. (lb.)
36X20	DFY3620P401	47,520.00	4750
36X24	DFY3624P401	48,012.00	4920
36X30	DFY3630P401	54,705.00	5255
36X36	DFY3636P401	56,251.00	5740
42X12	DFY4212P401	59,123.00	5725
42X14	DFY4214P401	59,215.00	5800
42X16	DFY4216P401	59,383.00	5850
42X18	DFY4218P401	59,471.00	6000
42X20	DFY4220P401	59,811.00	6680
42X24	DFY4224P401	59,837.00	6850
42X30	DFY4230P401	75,586.00	7185
42X36	DFY4236P401	79,694.00	7670
42X42	DFY4242P401	1,01,555.00	9185
48X12	DFY4812P401	78,422.00	7200
48X14	DFY4814P401	78,422.00	7276
48X16	DFY4816P401	78,676.00	7400
48X18	DFY4818P401	78,676.00	7620
48X20	DFY4820P401	79,009.00	7685
48X24	DFY4824P401	79,601.00	8695
48X30	DFY4830P401	80,784.00	5573
48X36	DFY4836P401	99,667.00	9515
48X42	DFY4842P401	1,02,116.00	11030
48X48	DFY4848P401	1,33,648.00	12115
54X24	DFY5424P401	POA	6220
54X30	DFY5430P401	POA	7478
54X36	DFY5436P401	POA	7600
54X42	DFY5442P401	POA	8930
54X48	DFY5448P401	POA	9480
54X54	DFY5454P401	POA	11780
60X30	DFY6030P401	POA	9045

P401 P401 P401 P401 P401 P401 P401 P401 P401 P401

ECCENTRIC REDUCER

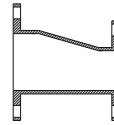

Size (in)	Item No.	List Price (\$)	Wt. (lb.)
3 X 2	DFER0302P401	POA	16
4 X 2	DFER0402P401	POA	25
4 X 3	DFER0403P401	459.00	30
6 X 2	DFER0602P401	POA	35
6 X 3	DFER0603P401	642.00	40
6 X 4	DFER0604P401	690.00	45
6 X 5	DFER0605P401	748.00	52
8 X 3	DFER0803P401	959.00	60
8 X 4	DFER0804P401	POA	65
8 X 5	DFER0805P401	1,003.00	70
8 X 6	DFER0806P401	1,040.00	75
10X 4	DFER1004P401	1,228.00	85
10X 6	DFER1006P401	1,268.00	90
10X 8	DFER1008P401	1,432.00	110
12X 4	DFER1204P401	1,619.00	120
12X 6	DFER1206P401	1,702.00	130
12X 8	DFER1208P401	1,824.00	145
12X10	DFER1210P401	2,030.00	170
14X 6	DFER1406P401	2,015.00	155
14X 8	DFER1408P401	2,138.00	175
14X10	DFER1410P401	2,299.00	190
14X12	DFER1412P401	2,588.00	248
16X 6	DFER1606P401	2,405.00	190
16X 8	DFER1608P401	2,567.00	210
16X10	DFER1610P401	2,775.00	235
16X12	DFER1612P401	3,019.00	265
16X14	DFER1614P401	3,141.00	280
18X 8	DFER1808P401	2,921.00	240
18X10	DFER1810P401	3,127.00	265
18X12	DFER1812P401	3,371.00	295
18X14	DFER1814P401	3,495.00	310
18X16	DFER1816P401	3,740.00	340
20X 8	DFER2008P401	POA	
20X10	DFER2010P401	3,795.00	310

Size (in)	Item No.	List Price (\$)	Wt. (lb.)
20X12	DFER2012P401	4,106.00	345
20X14	DFER2014P401	4,195.00	355
20X16	DFER2016P401	4,503.00	390
20X18	DFER2018P401	4,679.00	410
24X 8	DFER2408P401	POA	
24X10	DFER2410P401	POA	
24X12	DFER2412P401	5,509.00	480
24X14	DFER2414P401	5,597.00	490
24X16	DFER2416P401	5,906.00	525
24X18	DFER2418P401	6,127.00	550
24X20	DFER2420P401	6,481.00	590
30X10	DFER3010P401	POA	
30X14	DFER3014P401	11,304.00	825
30X16	DFER3016P401	10,437.00	770
30X18	DFER3018P401	9,300.00	810
30X20	DFER3020P401	9,821.00	870
30X24	DFER3024P401	10,767.00	970
36X14	DFER3614P401	POA	1290
36X16	DFER3616P401	POA	1105
36X18	DFER3618P401	POA	
36X20	DFER3620P401	POA	1230
36X24	DFER3624P401	14,584.00	1345
36X30	DFER3630P401	POA	1555
42X24	DFER4224P401	20,595.00	1820
42X30	DFER4230P401	23,020.00	2060
42X36	DFER4236P401	25,898.00	2550
48X24	DFER4824P401	POA	
48X30	DFER4830P401	29,042.00	2625
48X36	DFER4836P401	32,325.00	2950
48X42	DFER4842P401	36,063.00	3320
54X30	DFER5430P401	POA	1625
54X36	DFER5436P401	POA	1680
54X42	DFER5442P401	POA	1800
54X48	DFER5448P401	POA	1695

P401 P401 P401 P401 P401 P401 P401 P401 P401 P401



SIP Industries

Quality Manufacturers Since 1960

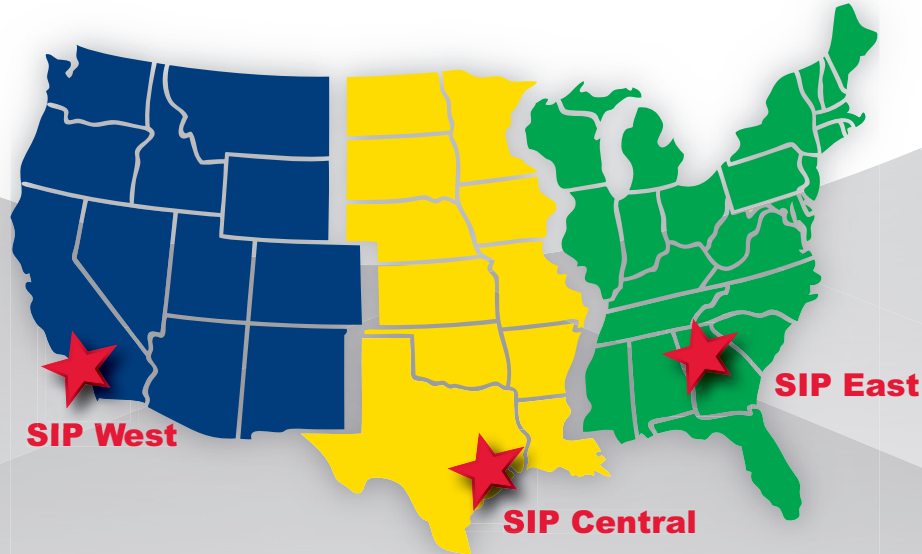

PRODUCT LINE

AWWA DI Fittings & Accessories

- C153 Compact MJ Fittings and Acc. 2" - 64"
- C110 Full Body MJ Fittings 2" - 64"
- C153 Trim Tyton® Push-On Fittings 4" - 24"
- C110 Flange Fittings 2" - 64"
- MJ x MJ Adapter for Connecting MJ Bells 3" - 24"
- Stainless Steel & Blue T-Bolts
- Made in India, China & Mexico
- Bare, Cement, Zinc, FBE & Other Linings

Joint Restraint System

- EZD Joint Restraint for DI Pipe 3" - 48"
- EZDTP Joint Restraint Tandem for DI Pipe 3" - 48"
- EZDPTP Joint Restraint for Push-On Joints DI Pipe 3" - 48"
- Ductile Iron Retainer Glands 3" - 30"
- FAR / FAH Flange Adapter for DI Pipe 3" - 48"
- EZFA Restrained Flange Adapter for DI and PVC Pipe 3" - 36"
- EZPVC Joint Restraint for PVC Pipe 3" - 36"
- ULTRA Joint Restraint for PVC Pipe 4" - 12"
- EZPVCPTP Joint Restraint for Push-On Joints PVC Pipe 14" - 36"
- PTPVC Pipe to Pipe Restraint 4" - 48"
- PTPDF Pipe to MJ Fittings Restraint 4" - 48"
- PTPFC Pipe to PVC Fittings Restraint 4" - 12"
- Made in China & USA
- EZ Shield or Shop Coating

Municipal Construction Castings

- Manhole Rings and Cover
- Frames and Grates
- Valve Boxes and Service Boxes
- Water Meter Covers and Boxes
- Cleanout and Monument Boxes
- Detectable Warning Plates
- Extension Rings
- Trench Grates and Tree Grates
- Made in India & USA

Fabrication Products for DI Pipe

- High Hub Flanges Class 150 and 250. 3" - 64"
- Threaded Bell Flanges 3" - 48"
- Anchor Flanges 3" - 60"
- Filler Flanges 4" - 30"

Other Products and Services

- All Thread Rod
- Pipe Lube and Hydraulic Cement
- Socket Clamps and Lugs
- Flange Packs
- OEM Castings



SIP CORPORATE 8876 Gulf Freeway, Suite 500, Houston, TX 77017

SIP CENTRAL 2900 Patio Drive, Houston, TX 77017

SIP EAST 600 Rayloc Drive, Atlanta, GA 30336

SIP WEST 8333 Almeria Avenue, Fontana, CA 92335

Phone: 877-921-6111 or 713-923-6111 | Fax: 713-923-6114 | www.sipindustries.com | sales@sipindustries.com