



# SIP Industries



Quality Manufacturers Since 1960

## Utility Pipe Fittings

# PRICE LIST

Effective : January 14, 2019

[www.sipindustries.com](http://www.sipindustries.com)

Toll Free 877-921-6111



										NOTES

## TABLE OF CONTENTS

GENERAL TERMS & CONDITIONS.....	Page : P002 - P004
FLANGE FITTINGS ANSI/AWWA C110/A21.10.....	Page : P005 - P018
FLANGE FITTINGS ZINC COATED ANSI/AWWA C110/A21.10.....	Page : P019 - P032
FLANGE FITTINGS FUSION BONDED EPOXY ANSI/AWWA C110/A21.10.....	Page : P033 - P046
FLANGE FITTINGS CERAMIC EPOXY (P401) LINED ANSI/AWWA C110/A21.10.....	Page : P047 - P060

- All dimensions are in inches unless noted otherwise.
- All weights are approximate in pounds unless noted otherwise.
- POA = Price on availability.
- R = Available multiple size reductions.

## SIP INDUSTRIES

### GENERAL TERMS AND CONDITIONS OF SALE

**1. Acceptance.** All sales by SIP Industries (Seller) are made pursuant to these Terms and Conditions. Submission of a purchase order to Seller, and/or acceptance of goods delivered by Seller, shall be deemed an acceptance of these Terms and Conditions by Purchaser. Please note that these Terms and Conditions may be modified from time to time; the applicable Terms and Conditions are those posted on SIP's website, [www.sipindustries.com](http://www.sipindustries.com), at the time that a purchase order is accepted or an agreement otherwise confirmed. Purchaser's alteration or addition to these Terms and Conditions, as same may be in effect from time to time, is expressly rejected unless accepted in writing by an authorized representative of Seller.

**2. Entire Agreement.** These Terms and Conditions, together with Seller's price list and Purchaser's purchase order, when accepted by Seller, shall be the entire agreement between Seller and Purchaser. Neither Seller nor Purchaser is relying on any representations, warranties or agreements except as expressly provided in these Terms and Conditions and in an accepted purchase order. To the extent of any conflict between the terms of a purchase order or any other documents submitted by Purchaser, on the one hand, and these Terms and Conditions, on the other, these Terms and Conditions shall govern.

**3. Prices.** Prices and descriptions of goods stated in Seller's price lists are subject to change without notice. Prices are subject to tariffs, raw material surcharges, labor disputes and shipping surcharges. To submit a purchase order, SIP Industries item numbers and part codes should be included. Seller's quotations are on globally sourced products unless otherwise noted. The ordering party is responsible to specify any required origin as required for end use. Quotations, if provided by Seller, expire sixty (60) days from the date provided unless otherwise agreed in writing.

**4. Terms.** Invoices are due and payable thirty (30) days from date of shipment, unless otherwise written on the invoice or confirmed in writing by Seller. A five percent (5%) late fee will be charged on all past-due accounts. If it becomes necessary to retain attorneys to collect an account, the Purchaser is liable for Seller's attorney's fees and other costs of collection.

**5. FOB point of shipment.** All prices are FOB point of shipment, unless otherwise agreed in writing. Seller's responsibility for goods therefore ceases and title passes to the Purchaser at the point of shipment; all claims for damages or losses in transit must be directed to the carrier with copy to Seller within ten (10) days of shipment.

**6. Delivery.** Seller shall have the right to select the freight carrier unless otherwise agreed. Seller has the right to substitute material with same function and design to accommodate unforeseen delays, shortages or restrictions.

**7. Cancellations, Changes and Returns.** All cancellations, changes and returns must be accepted in writing by an authorized representative of Seller, otherwise they will not be valid and binding on Seller. Seller will not be responsible for unauthorized returned product. It will be the responsibility of purchaser at their expense to have unauthorized product returned or disposed of. Seller shall not be obligated to accept any cancellation, change or return, but if it does so the following terms shall apply: (i) goods must be returned to Seller's facility, in the same condition in which they were accepted by Purchaser; (ii) a handling charge of thirty-five percent (35%) of the purchase price will be deducted from the credit given to Purchaser; and (iii) shipping charges, if not prepaid by Purchaser, will likewise be deducted from the credit given to Purchaser.

**8. Specially Manufactured Goods.** Unless otherwise agreed, specially-manufactured goods, including goods designed to the Purchaser's specifications, may not be cancelled or returned once work has begun to design or manufacture the goods unless an agreement is reached and confirmed in writing by Seller, including compensation to Seller for work thus far done with respect to the goods.

**9. Delays; Force Majeure.** Seller shall not be liable for any expenses, loss or damage resulting from any delay in delivery of goods or other failure of Seller's performance due to fire, floods, acts of god, strikes, labor disputes, labor shortages, riots, accidents, transportation delays or other causes beyond the reasonable control of Seller.

**10. Disclaimer regarding weights.** All stated weights are approximate and are given for inventory and shipping purposes only.



**11. Taxes.** Seller's prices do not include sales, excise or other taxes. Purchaser shall pay all such taxes. If Purchaser claims a tax exemption, Purchaser shall provide Seller with the necessary tax-exemption numbers and certificates. If Seller accepts an exemption but is later required by the taxing authority to pay taxes, Purchaser shall reimburse to Seller the amount of such taxes.

**12. Limited Warranty.** For a period of one calendar year from the date of shipment, Seller warrants that goods sold and delivered by Seller to Purchaser will conform to the number and type of goods described in the accepted purchase order and that such goods will be free from defects in material and workmanship.

THIS LIMITED WARRANTY IS SELLER'S SOLE AND EXCLUSIVE WARRANTY. SELLER MAKES NO OTHER WARRANTY OF ANY KIND, EXPRESS OR IMPLIED. SELLER DOES NOT WARRANT THAT THE GOODS ARE FIT FOR ANY PARTICULAR PURPOSE. SELLER DOES NOT WARRANT THAT THE GOODS ARE MERCHANTABILITY.

**13. Product Disclaimers.** All tooling required to manufacture products are the property of Seller even if tooling costs are incurred by Purchaser. Seller has the right to change product design, engineering, materials, tooling and processes that do not affect the intended use and application of the product. Seller will notify Purchaser if changes are substantial and may affect the application or appearance of the product. Furthermore, references to Buyer's specifications and similar requirements are only to describe the goods and do not give rise to any representation, warranty or other sales term.

Seller manufactures to industry standards and makes every effort to address applications of its products. Please see current technical advisory at Seller's web site, sipindustries.com, for up to date product support and recommendations. All product dimension, designs, technology, tooling, process, software, innovations, and drawings are considered intellectual property and are owned and confidential to Seller. Purchaser has no rights or privileges to SIP industries intellectual property including product applications without Seller's express written consent.

**14. Prompt notice required for Limited Warranty claims.** Buyer is responsible for promptly inspecting goods on delivery and notifying Seller, within sixty (60) days of delivery to Buyer, of any nonconformity or defect that would be discovered on a reasonable and customary inspection. Provided that such notice is given and that the warranty claim is made within one year, Seller will provide a replacement or price adjustment, in Seller's discretion, not to exceed the net sales price of the defective product. However, this warranty shall be of no force or effect absent such timely notice. Seller shall not in any event be responsible for labor, removal or installation charges incurred in connection with the replacement of defective goods.

**15. Conditions to Limited Warranty.** Purchaser shall notify Seller immediately upon discovery of a defect so that Seller may inspect the product in its installed condition. Seller shall not be responsible for defects or failures in goods of which it is not so notified; nor shall Seller be responsible for goods manufactured or sold by other parties or losses or impairments caused by such goods; nor shall Seller be responsible for defects or failure of goods due to improper installation, improper usage, normal or abnormal wear and tear, erosion or corrosion, improper storage, use or maintenance, vandalism, vehicular or other accidents, or storms or other forces beyond the control of the parties. Seller also shall not be responsible for goods that have been damaged by misuse, negligence or accident or that have been altered or repaired by any party other than Seller.

**16. Limitation on Liability.** In the event any remedy hereunder fails of its essential purpose and monetary damages may be imposed, Seller's liability, whether founded in contract or tort (including negligence), arising out of or resulting from (i) the Purchase Order and resulting contract or the performance or breach thereof, or (ii) the design, manufacture, delivery, sale, repair, replacement or use of the goods, shall not exceed the cost of the goods at issue in the claim. NOTWITHSTANDING ANYTHING CONTAINED HEREIN TO THE CONTRARY, SELLER SHALL NOT BE LIABLE TO PURCHASER OR ANY OTHER PERSON FOR CONSEQUENTIAL, INCIDENTAL, SPECIAL, EXEMPLARY, PUNITIVE OR OTHER INDIRECT DAMAGES, INCLUDING, WITHOUT LIMITATION, LOSS OF PROFITS, RECALL-RELATED EXPENSES, AND LOSS OF USE OF THE GOODS.

**17. Purchaser specifications.** If Seller has designed the goods using information provided by Purchaser, Seller shall not be responsible for design errors resulting from inaccurate or incomplete information supplied by Purchaser. If

Purchaser has provided specifications or a model or sample from which a good is designed and manufactured, Seller shall not be responsible for any defect, error or inadequacy provided that the good is designed or manufactured in compliance with Purchaser's specifications, model or sample.

**18. Solvency and Security Interest.** By submitting a Purchase Order, Buyer represents to Seller that Buyer is solvent and capable of timely fulfilling its payment and other obligations to Seller. Until the goods and any other indebtedness of Buyer have been paid in full, Buyer, its agents any successors: (i) will hold the goods subject to a security interest in favor of Seller allowing for the right or re-possession by Seller to the extent permitted by applicable law, (ii) will not alter, remove, destroy, or damage any identifying mark on the goods or their packaging, and (iii) will keep the goods separate from any other products.

**19. Governing law; venue.** All sales shall be governed by the law of the state of Texas. In the event that a lawsuit is filed between the parties on any claim arising out of or in connection with such sales, Seller and Purchaser agree that exclusive venue and jurisdiction shall be in the state or federal courts of Harris County, Texas.

**20. Attorney's fees and costs.** In the event of litigation between the parties with respect to the sale of goods, the prevailing party shall be entitled to recover its reasonable attorney's fees and costs, including expert witness fees.

# Utility Pipe Fittings & Accessories

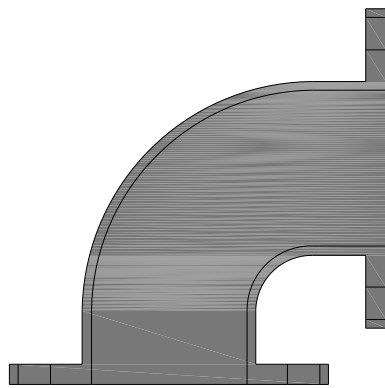

ANSI/AWWA C110/A21.10  
**FLANGE FITTINGS**

**PRICE LIST**  
Effective January 14, 2019.

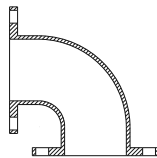

**FLANGE BENDS**  
**90° (1/4)**

Size (in.)	Item No.	List Price (\$)	Wt. (lb.)
2	DFB9002	102.00	14
3	DFB9003	118.00	25
4	DFB9004	183.00	45
5	DFB9005	POA	62
6	DFB9006	283.00	65
8	DFB9008	464.00	105
10	DFB9010	736.00	165
12	DFB9012	958.00	235
14	DFB9014	1,260.00	290
16	DFB9016	1,553.00	370
18	DFB9018	2,098.00	450
20	DFB9020	2,566.00	580
24	DFB9024	4,229.00	900
30	DFB9030	7,452.00	1430
36	DFB9036	10,920.00	2135
42	DFB9042	19,048.00	3055
48	DFB9048	25,532.00	4095
54	DFB9054	POA	3740
64	DFB9064	POA	6752

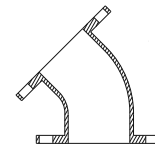
**FLANGE BENDS**  
**45° (1/8)**

Size (in.)	Item No.	List Price (\$)	Wt. (lb.)
2	DFB4502	109.00	12
3	DFB4503	92.00	20
4	DFB4504	163.00	40
5	DFB4505	POA	52
6	DFB4506	252.00	55
8	DFB4508	383.00	90
10	DFB4510	619.00	130
12	DFB4512	809.00	195
14	DFB4514	958.00	220
16	DFB4516	1,218.00	280
18	DFB4518	1,648.00	325
20	DFB4520	2,156.00	430
24	DFB4524	2,994.00	630
30	DFB4530	6,548.00	1120
36	DFB4536	10,262.00	1755
42	DFB4542	16,209.00	2600
48	DFB4548	22,322.00	3580
54	DFB4554	POA	2735

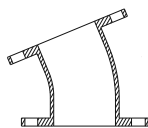
**FLANGE BENDS**  
**22½° (1/16)**

Size (in.)	Item No.	List Price (\$)	Wt. (lb.)
2	DFB2202	148.00	12
3	DFB2203	104.00	20
4	DFB2204	162.00	40
6	DFB2206	240.00	55
8	DFB2208	374.00	90
10	DFB2210	592.00	135
12	DFB2212	868.00	205
14	DFB2214	1,143.00	225
16	DFB2216	1,259.00	285
18	DFB2218	1,699.00	335
20	DFB2220	2,375.00	435
24	DFB2224	3,493.00	640
30	DFB2230	6,636.00	1135
36	DFB2236	10,466.00	1790
42	DFB2242	16,617.00	2665
48	DFB2248	22,852.00	3665
54	DFB2254	POA	2260

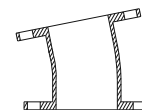
**FLANGE BENDS**  
**11¼° (1/32)**

Size (in.)	Item No.	List Price (\$)	Wt. (lb.)
2	DFB1102	148.00	12
3	DFB1103	104.00	20
4	DFB1104	195.00	40
6	DFB1106	303.00	55
8	DFB1108	400.00	90
10	DFB1110	687.00	135
12	DFB1112	1,043.00	205
14	DFB1114	1,188.00	225
16	DFB1116	1,447.00	285
18	DFB1118	1,699.00	335
20	DFB1120	2,375.00	435
24	DFB1124	3,670.00	645
30	DFB1130	6,725.00	1150
36	DFB1136	10,553.00	1805
42	DFB1142	16,710.00	2680
48	DFB1148	23,038.00	3695
54	DFB1154	POA	2100

CALL FOR BARE/BARE FITTINGS



**90° LONG RADIUS BENDS**

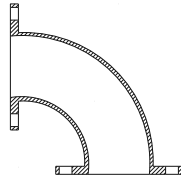

Size (in.)	Item No.	List Price (\$)	Wt. (lb.)
3	DFBLR9003	155.00	30
4	DFBLR9004	256.00	30
5	DFBLR9005	POA	76
6	DFBLR9006	445.00	80
8	DFBLR9008	738.00	140
10	DFBLR9010	1,092.00	215
12	DFBLR9012	1,648.00	325
14	DFBLR9014	1,954.00	580
16	DFBLR9016	2,562.00	740
18	DFBLR9018	3,194.00	840
20	DFBLR9020	4,422.00	928
24	DFBLR9024	6,766.00	1640
30	DFBLR9030	12,306.00	2105
36	DFBLR9036	19,203.00	3285
42	DFBLR9042	30,333.00	4865
48	DFBLR9048	42,335.00	7800
54	DFBLR9054	POA	6205

**90° FLANGE X FLARE BENDS**

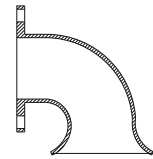

Size (in.)	Item No.	List Price (\$)	Wt. (lb.)
3	DFF9003	130.00	25
4	DFF9004	232.00	40
6	DFF9006	358.00	70
8	DFF9008	609.00	110
10	DFF9010	992.00	175
12	DFF9012	1,244.00	245
14	DFF9014	1,725.00	340
16	DFF9016	2,333.00	460
18	DFF9018	2,839.00	560
20	DFF9020	3,820.00	700
24	DFF9024	5,430.00	1100
30	DFF9030	11,517.00	1840
36	DFF9036	15,958.00	2700
42	DFF9042	19,952.00	3250
48	DFF9048	32,639.00	4215
54	DFF9054	POA	3965

**STRAIGHT FLANGE X FLARE**

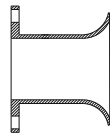

Size (in.)	Item No.	List Price (\$)	Wt. (lb.)
3	DFP03	104.00	20
4	DFP04	155.00	30
6	DFP06	204.00	40
8	DFP08	358.00	70
10	DFP10	484.00	95
12	DFP12	787.00	115
14	DFP14	839.00	190
16	DFP16	1,218.00	330
18	DFP18	1,396.00	355
20	DFP20	1,945.00	460
24	DFP24	2,620.00	635
30	DFP30	6,432.00	1025
36	DFP36	8,535.00	1460
42	DFP42	10,913.00	1900
48	DFP48	14,808.00	2350
54	DFP54	POA	2035

**LONG RADIUS 90° FLANGE X FLARE BENDS**

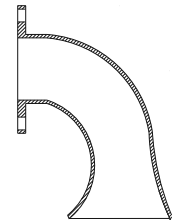

Size (in.)	Item No.	List Price (\$)	Wt. (lb.)
3	DFFLR9003	179.00	30
4	DFFLR9004	256.00	50
6	DFFLR9006	459.00	90
8	DFFLR9008	787.00	115
10	DFFLR9010	1,270.00	250
12	DFFLR9012	1,903.00	375
14	DFFLR9014	2,535.00	500
16	DFFLR9016	3,624.00	715
18	DFFLR9018	4,054.00	800
20	DFFLR9020	6,219.00	1140
24	DFFLR9024	7,286.00	1335
30	DFFLR9030	12,803.00	2190
36	DFFLR9036	20,256.00	3465
42	DFFLR9042	32,109.00	5150
48	DFFLR9048	41,927.00	6725

**CALL FOR BARE/BARE FITTINGS**

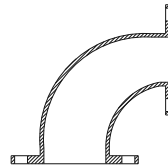
**90° REDUCING BENDS**

Size (in.)	Item No.	List Price (\$)	Wt. (lb.)
4 X 3	DFBR0403	150.00	35
6 X 3	DFBR0603	285.00	45
6 X 4	DFBR0604	280.00	55
6 X 5	DFBR0605	285.00	65
8 X 4	DFBR0804	383.00	80
8 X 5	DFBR0805	617.00	100
8 X 6	DFBR0806	435.00	90
10X 4	DFBR1004	662.00	105
10X 6	DFBR1006	687.00	125
10X 8	DFBR1008	763.00	150
12X 4	DFBR1204	712.00	145
12X 6	DFBR1206	813.00	165
12X 8	DFBR1208	967.00	190
12X10	DFBR1210	1,014.00	220
14X 6	DFBR1406	967.00	144
14X 8	DFBR1408	1,092.00	200
14X10	DFBR1410	1,218.00	260
14X12	DFBR1412	1,372.00	270
16X 6	DFBR1606	1,116.00	220
16X 8	DFBR1608	1,218.00	240
16X10	DFBR1610	1,420.00	344
16X12	DFBR1612	1,573.00	373
16X14	DFBR1614	1,699.00	330
18X 6	DFBR1806	1,319.00	260
18X 8	DFBR1808	1,648.00	280
18X10	DFBR1810	1,675.00	320
18X12	DFBR1812	1,777.00	465
18X14	DFBR1814	1,954.00	370
18X16	DFBR1816	2,129.00	410
20X 6	DFBR2006	1,748.00	320
20X 8	DFBR2008	1,885.00	345
20X10	DFBR2010	2,430.00	385
20X12	DFBR2012	2,524.00	415
20X14	DFBR2014	2,828.00	518
20X16	DFBR2016	2,703.00	533
20X18	DFBR2018	2,867.00	515
24X 6	DFBR2406	2,620.00	480
24X 8	DFBR2408	2,758.00	505
24X10	DFBR2410	2,975.00	545
24X12	DFBR2412	3,139.00	575
24X14	DFBR2414	3,467.00	595
24X16	DFBR2416	3,739.00	635
24X18	DFBR2418	3,793.00	675

Size (in.)	Item No.	List Price (\$)	Wt. (lb.)
24X20	DFBR2420	4,038.00	740
30X12	DFBR3012	4,910.00	840
30X14	DFBR3014	5,986.00	860
30X16	DFBR3016	5,262.00	900
30X18	DFBR3018	8,208.00	940
30X20	DFBR3020	8,673.00	1005
30X24	DFBR3024	7,046.00	1165
36X12	DFBR3612	6,987.00	1195
36X14	DFBR3614	9,294.00	1215
36X16	DFBR3616	7,338.00	1255
36X18	DFBR3618	9,819.00	1295
36X20	DFBR3620	10,148.00	1315
36X24	DFBR3624	9,267.00	1520
36X30	DFBR3630	10,756.00	1785
42X12	DFBR4212	POA	1655
42X14	DFBR4214	12,925.00	1675
42X16	DFBR4216	10,695.00	1715
42X18	DFBR4218	14,714.00	1755
42X20	DFBR4220	14,379.00	1820
42X24	DFBR4224	12,347.00	1980
42X30	DFBR4230	14,622.00	2245
42X36	DFBR4236	21,137.00	2600
48X12	DFBR4812	13,562.00	2175
48X14	DFBR4814	16,692.00	2195
48X16	DFBR4816	13,936.00	2235
48X18	DFBR4818	20,612.00	2275
48X20	DFBR4820	22,405.00	2340
48X24	DFBR4824	20,202.00	2500
48X30	DFBR4830	21,948.00	2765
48X36	DFBR4836	22,558.00	3115
48X42	DFBR4842	29,209.00	3580
54X12	DFBR5412	POA	1990
54X14	DFBR5414	POA	2015
54X16	DFBR5416	POA	2055
54X18	DFBR5418	POA	2095
54X20	DFBR5420	POA	2160
54X24	DFBR5424	POA	2320
54X30	DFBR5430	POA	2585
54X36	DFBR5436	POA	2940
54X42	DFBR5442	POA	3395
54X48	DFBR5448	POA	3565

CALL FOR BARE/BARE FITTINGS

**90° BASE BENDS**

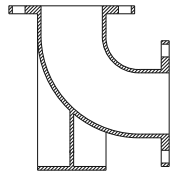

Size (in.)	Item No.	List Price (\$)	Wt. (lb.)
3	DFBB9003	179.00	35
4	DFBB9004	280.00	55
6	DFBB9006	397.00	85
8	DFBB9008	772.00	145
10	DFBB9010	1,066.00	210
12	DFBB9012	1,516.00	300
14	DFBB9014	1,827.00	320
16	DFBB9016	2,257.00	445
18	DFBB9018	2,866.00	565
20	DFBB9020	3,820.00	700
24	DFBB9024	5,620.00	1030
30	DFBB9030	9,499.00	1625
36	DFBB9036	13,943.00	2385
42	DFBB9042	26,872.00	3465
48	DFBB9048	28,743.00	4610
54	DFBB9054	POA	4415

**90° LONG RADIUS BASE BENDS**

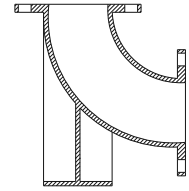

Size (in.)	Item No.	List Price (\$)	Wt. (lb.)
3	DFBBLR9003	195.00	40
4	DFBBLR9004	306.00	60
6	DFBBLR9006	507.00	100
8	DFBBLR9008	915.00	180
10	DFBBLR9010	1,319.00	260
12	DFBBLR9012	2,115.00	390
14	DFBBLR9014	2,115.00	650
16	DFBBLR9016	3,750.00	815
18	DFBBLR9018	4,054.00	955
20	DFBBLR9020	5,376.00	1200
24	DFBBLR9024	7,803.00	1770
30	DFBBLR9030	14,028.00	2295
36	DFBBLR9036	21,510.00	3535
42	DFBBLR9042	34,385.00	5275
48	DFBBLR9048	47,600.00	7305
54	DFBBLR9054	POA	6880

**BASE TEES**

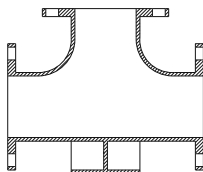

Size (in.)	Item No.	List Price (\$)	Wt. (lb.)
3	DFTB0303	232.00	45
4	DFTB0404	383.00	75
6	DFTB0606	559.00	110
8	DFTB0808	942.00	185
10	DFTB1010	1,522.00	300
12	DFTB1212	2,180.00	430
14	DFTB1414	2,460.00	500
16	DFTB1616	3,042.00	600
18	DFTB1818	3,750.00	740
20	DFTB2020	5,075.00	930
24	DFTB2424	7,694.00	1410
30	DFTB3030	13,270.00	2270
36	DFTB3636	19,406.00	3320
42	DFTB4242	36,472.00	5850
48	DFTB4848	48,132.00	7720
54	DFTB5454	POA	6465

**CALL FOR BARE/BARE FITTINGS**

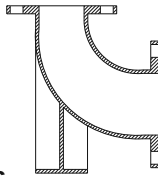
**90° REDUCING BASE BENDS**  
 (WITH BASE UNDER SMALL END)

R - Available multiple size reductions.

Size (in.)	Item No.	List Price (\$)	Wt. (lb.)
4 X 3	DFBBSDR0403	POA	45
6 X 4	DFBBSDR0604	POA	75
8 X 4	DFBBSDR0804	POA	120
8 X 6	DFBBSDR0806	POA	130
10X 6	DFBBSDR1006	POA	170
10X 8	DFBBSDR1008	POA	195
12X 6	DFBBSDR1206	POA	230
12X 8	DFBBSDR1208	POA	255
12X10	DFBBSDR1210	POA	285
14X R	DFBBSDR14	POA	
16X R	DFBBSDR16	POA	
18X R	DFBBSDR18	POA	
20X R	DFBBSDR20	POA	
24X R	DFBBSDR24	POA	
30X R	DFBBSDR30	POA	
36X R	DFBBSDR36	POA	
42X R	DFBBSDR42	POA	
48X R	DFBBSDR48	POA	
54X R	DFBBSDR54	POA	

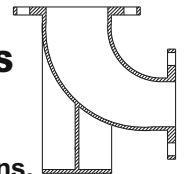
**90° REDUCING BASE BENDS**  
 (WITH BASE UNDER LARGE END)

R - Available multiple size reductions.

Size (in.)	Item No.	List Price (\$)	Wt. (lb.)
4 X 3	DFBBLDR0403	POA	45
6 X 4	DFBBLDR0604	POA	75
8 X 4	DFBBLDR0804	POA	120
8 X 6	DFBBLDR0806	POA	130
10X 6	DFBBLDR1006	POA	170
10X 8	DFBBLDR1008	POA	195
12X 6	DFBBLDR1206	POA	230
12X 8	DFBBLDR1208	POA	255
12X10	DFBBLDR1210	POA	285
14X R	DFBBLDR14	POA	
16X R	DFBBLDR16	POA	
18X R	DFBBLDR18	POA	
20X R	DFBBLDR20	POA	
24X R	DFBBLDR24	POA	
30X R	DFBBLDR30	POA	
36X R	DFBBLDR36	POA	
42X R	DFBBLDR42	POA	
48X R	DFBBLDR48	POA	
54X R	DFBBLDR54	POA	

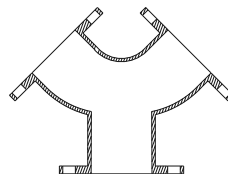
**TRUE WYES**

Size (in.)	Item No.	List Price (\$)	Wt. (lb.)
4 X 4 X 4	DFYT040404	256.00	50
6 X 4 X 4	DFYT060404	POA	75
6 X 6 X 6	DFYT060606	408.00	80
8 X 8 X 4	DFYT080804	435.00	87
8 X 6 X 6	DFYT080606	POA	120
8 X 8 X 8	DFYT080808	712.00	125
10 X 10 X 6	DFYT101006	712.00	142
10 X 8 X 8	DFYT100808	787.00	155
10 X 10 X	DFYT101010	942.00	185
12 X 12 X 6	DFYT121206	813.00	173
12 X 12 X 8	DFYT121208	1,066.00	225

Size (in.)	Item No.	List Price (\$)	Wt. (lb.)
12 X 12 X 10	DFYT121210	1,218.00	300
12 X 12 X 12	DFYT121212	1,522.00	300
14 X 14 X 14	DFYT141414	2,105.00	415
16 X 16 X 16	DFYT161616	2,942.00	580
18 X 18 X 18	DFYT181818	3,447.00	680
20 X 20 X 20	DFYT202020	5,239.00	960
24 X 24 X 24	DFYT242424	7,476.00	1370
30 X 30 X 30	DFYT303030	POA	80
36 X 36 X 36	DFYT363636	POA	120
42 X 42 X 42	DFYT424242	POA	125
48 X 48 X 48	DFYT484848	POA	120

CALL FOR BARE/BARE FITTINGS

**FLANGE TEES**

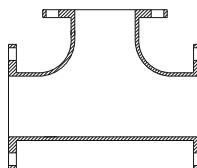

Size (in.)	Item No.	List Price (\$)	Wt. (lb.)
2 X 2	DFT0202	128.00	20
2½ X 2½	DFT02.5	POA	30
3 X 2	DFT0302	179.00	35
3 X 3	DFT0303	169.00	40
4 X 2	DFT0402	256.00	50
4 X 3	DFT0403	306.00	60
4 X 4	DFT0404	334.00	65
5 X 5	DFT0505	POA	80
6 X 2	DFT0602	435.00	156
6 X 3	DFT0603	435.00	85
6 X 4	DFT0604	459.00	90
6 X 6	DFT0606	415.00	95
8 X 3	DFT0803	702.00	130
8 X 4	DFT0804	643.00	140
8 X 6	DFT0806	598.00	145
8 X 8	DFT0808	692.00	155
10 X 4	DFT1004	923.00	205
10 X 6	DFT1006	863.00	215
10 X 8	DFT1008	905.00	225
10 X 10	DFT1010	1,052.00	270
12 X 4	DFT1204	1,254.00	290
12 X 6	DFT1206	1,206.00	295
12 X 8	DFT1208	1,270.00	310
12 X 10	DFT1210	1,514.00	360
12 X 12	DFT1212	1,528.00	385
14 X 4	DFT1404	POA	370
14 X 6	DFT1406	1,903.00	375
14 X 8	DFT1408	1,978.00	390
14 X 10	DFT1410	2,028.00	400
14 X 12	DFT1412	2,155.00	425
14 X 14	DFT1414	2,206.00	435
16 X 4	DFT1604	3,329.00	460
16 X 6	DFT1606	2,190.00	465
16 X 8	DFT1608	2,118.00	475
16 X 10	DFT1610	2,487.00	495
16 X 12	DFT1612	2,368.00	520
16 X 14	DFT1614	2,688.00	530
16 X 16	DFT1616	2,415.00	550
18 X 6	DFT1806	2,138.00	480

Size (in.)	Item No.	List Price (\$)	Wt. (lb.)
18 X 8	DFT1808	2,664.00	495
18 X 10	DFT1810	2,586.00	510
18 X 12	DFT1812	2,845.00	535
18 X 14	DFT1814	3,143.00	630
18 X 16	DFT1816	3,295.00	650
18 X 18	DFT1818	3,007.00	665
20 X 4	DFT2004	POA	845
20 X 6	DFT2006	3,332.00	610
20 X 8	DFT2008	3,385.00	620
20 X 10	DFT2010	3,467.00	635
20 X 12	DFT2012	3,603.00	660
20 X 14	DFT2014	3,629.00	665
20 X 16	DFT2016	4,422.00	810
20 X 18	DFT2018	4,476.00	820
20 X 20	DFT2020	3,792.00	855
24 X 4	DFT2404	4,613.00	845
24 X 6	DFT2406	3,849.00	845
24 X 8	DFT2408	4,695.00	860
24 X 10	DFT2410	4,804.00	880
24 X 12	DFT2412	4,028.00	890
24 X 14	DFT2414	4,876.00	900
24 X 16	DFT2416	4,127.00	915
24 X 18	DFT2418	6,657.00	1220
24 X 20	DFT2420	6,849.00	1255
24 X 24	DFT2424	6,022.00	1330
30 X 6	DFT3006	8,508.00	1450
30 X 8	DFT3008	8,535.00	1465
30 X 10	DFT3010	8,712.00	1511
30 X 12	DFT3012	8,712.00	1490
30 X 14	DFT3014	8,712.00	1490
30 X 16	DFT3016	8,799.00	1505
30 X 18	DFT3018	8,858.00	1515
30 X 20	DFT3020	9,002.00	1540
30 X 24	DFT3024	11,838.00	2025
30 X 30	DFT3030	10,667.00	2150
36 X 6	DFT3606	11,692.00	2000
36 X 8	DFT3608	12,569.00	2150
36 X 10	DFT3610	12,598.00	2155
36 X 12	DFT3612	12,687.00	2170

Contd.....

**CALL FOR BARE/BARE FITTINGS**



**FLANGE TEES**

Contd.....

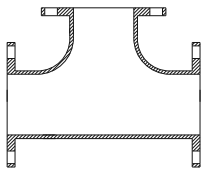

Size (in.)	Item No.	List Price (\$)	Wt. (lb.)
36 X 14	DFT3614	12,716.00	2175
36 X 16	DFT3616	12,774.00	2185
36 X 18	DFT3618	12,803.00	2190
36 X 20	DFT3620	12,919.00	2210
36 X 24	DFT3624	13,184.00	2255
36 X 30	DFT3630	17,535.00	3000
36 X 36	DFT3636	15,908.00	3160
42 X 12	DFT4212	19,734.00	3165
42 X 14	DFT4214	19,765.00	3170
42 X 16	DFT4216	19,827.00	3180
42 X 18	DFT4218	19,857.00	3185
42 X 20	DFT4220	19,984.00	3205
42 X 24	DFT4224	20,233.00	3245
42 X 30	DFT4230	25,718.00	4125
42 X 36	DFT4236	33,418.00	5360
42 X 42	DFT4242	34,790.00	5580
48 X 12	DFT4812	26,905.00	4315
48 X 14	DFT4814	26,905.00	4315
48 X 16	DFT4816	26,997.00	4330
48 X 18	DFT4818	26,997.00	4330
48 X 20	DFT4820	27,122.00	4350
48 X 24	DFT4824	27,339.00	4385
48 X 30	DFT4830	27,777.00	4455
48 X 36	DFT4836	34,634.00	5555
48 X 42	DFT4842	44,858.00	7195
48 X 48	DFT4848	46,043.00	7385
54X12	DFT5412	POA	4435
54X14	DFT5414	POA	4435
54X16	DFT5416	POA	4450
54X18	DFT5418	POA	4460
54X20	DFT5420	POA	4480
54X24	DFT5424	POA	4515
54X30	DFT5430	POA	4615
54X36	DFT5436	POA	4695
54X42	DFT5442	POA	5740
54X48	DFT5448	POA	5850
54X54	DFT5454	POA	6025

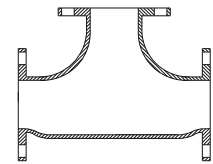
**FLANGE TEES - BULL HEAD**

Size (in.)	Item No.	List Price (\$)	Wt. (lb.)
4 X 4 X 6	DFTBH040406	653.00	90
6 X 6 X 8	DFTBH060608	719.00	140
8 X 8 X 10	DFTBH080810	1,319.00	260
8 X 8 X 12	DFTBH080812	1,285.00	291
10 X 10 X 12	DFTBH101012	1,904.00	355
36 X 36 X 48	DFTBH363648	POA	4361

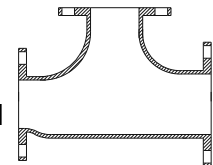
**FLANGE TEES - REDUCING ON THE RUN**

Size (in.)	Item No.	List Price (\$)	Wt. (lb.)
4 X 3 X 3	DFTROR040303	POA	55
6 X 4 X 4	DFTROR060404	459.00	103
6 X 4 X 6	DFTROR060406	459.00	108
8 X 6 X 4	DFTROR080604	637.00	146
8 X 6 X 6	DFTROR080606	738.00	148
8 X 6 X 8	DFTROR080608	813.00	145
10 X 6 X 6	DFTROR100606	1,492.00	275
10 X 6 X 10	DFTROR100610	1,429.00	305
10 X 8 X 6	DFTROR100806	1,502.00	280
10 X 8 X 8	DFTROR100808	1,585.00	302
10 X 8 X 10	DFTROR100810	1,625.00	325
12 X 6 X 6	DFTROR120606	1,855.00	340
12 X 6 X 8	DFTROR120608	1,943.00	360
12 X 8 X 6	DFTROR120806	1,904.00	355
12 X 8 X 8	DFTROR120808	2,010.00	375
12 X 8 X 12	DFTROR120812	2,253.00	420
12 X 10 X 6	DFTROR121006	1,812.00	390
12 X 10 X 8	DFTROR121008	2,145.00	400
12 X 10 X 10	DFTROR121010	2,253.00	420
12 X 10 X 12	DFTROR121012	2,359.00	440
36 X 24 X 24	DFTROR362424	POA	2255
36 X 30 X 30	DFTROR363030	POA	2575

CALL FOR BARE/BARE FITTINGS

**FLANGE CROSS**

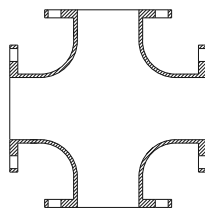

Size (in.)	Item No.	List Price (\$)	Wt. (lb.)
3 X 3	DFX0303	256.00	50
4 X 3	DFX0403	358.00	70
4 X 4	DFX0404	350.00	80
6 X 3	DFX0603	484.00	95
6 X 4	DFX0604	559.00	110
6 X 6	DFX0606	567.00	120
8 X 3	DFX0803	POA	140
8 X 4	DFX0804	787.00	155
8 X 6	DFX0806	839.00	175
8 X 8	DFX0808	848.00	195
10X 4	DFX1004	1,116.00	220
10X 6	DFX1006	1,218.00	240
10X 8	DFX1008	1,345.00	265
10X10	DFX1010	1,675.00	330
12X 4	DFX1204	1,573.00	310
12X 6	DFX1206	1,623.00	320
12X 8	DFX1208	1,750.00	345
12X10	DFX1210	2,105.00	415
12X12	DFX1212	1,896.00	460
14X 6	DFX1406	2,028.00	400
14X 8	DFX1408	2,155.00	425
14X10	DFX1410	2,333.00	460
14X12	DFX1412	2,562.00	505
14X14	DFX1414	2,688.00	530
16X 6	DFX1606	2,485.00	490
16X 8	DFX1608	2,637.00	520
16X10	DFX1610	2,814.00	555
16X12	DFX1612	3,068.00	605
16X14	DFX1614	POA	620
16X16	DFX1616	3,373.00	755
18X 6	DFX1806	2,562.00	505
18X 8	DFX1808	2,712.00	535
18X10	DFX1810	2,839.00	560
18X12	DFX1812	3,093.00	610
18X14	DFX1814	3,648.00	720
18X16	DFX1816	3,878.00	765
18X18	DFX1818	4,030.00	795
20X 6	DFX2006	3,467.00	635
20X 8	DFX2008	3,629.00	665
20X10	DFX2010	3,739.00	685

Size (in.)	Item No.	List Price (\$)	Wt. (lb.)
20X12	DFX2012	4,012.00	735
20X14	DFX2014	4,067.00	745
20X16	DFX2016	4,994.00	915
20X18	DFX2018	5,157.00	945
20X20	DFX2020	5,540.00	1015
24X 6	DFX2406	4,777.00	875
24X 8	DFX2408	4,884.00	895
24X10	DFX2410	5,075.00	930
24X12	DFX2412	5,239.00	960
24X14	DFX2414	5,320.00	975
24X16	DFX2416	5,513.00	1010
24X18	DFX2418	7,450.00	1365
24X20	DFX2420	7,803.00	1430
24X24	DFX2424	8,568.00	1570
30X12	DFX3012	9,150.00	1565
30X14	DFX3014	9,180.00	1570
30X16	DFX3016	9,384.00	1605
30X18	DFX3018	9,442.00	1515
30X20	DFX3020	9,764.00	1670
30X24	DFX3024	13,125.00	2245
30X30	DFX3030	14,614.00	2500
36X12	DFX3612	13,094.00	2240
36X14	DFX3614	13,094.00	2240
36X16	DFX3616	13,270.00	2270
36X18	DFX3618	13,328.00	2280
36X20	DFX3620	13,592.00	2325
36X24	DFX3624	14,059.00	2405
36X30	DFX3630	19,288.00	3300
36X36	DFX3636	21,159.00	3620
42X12	DFX4212	20,202.00	3240
42X14	DFX4214	20,202.00	3240
42X16	DFX4216	20,388.00	3270
42X18	DFX4218	20,419.00	3275
42X20	DFX4220	20,702.00	3320
42X24	DFX4224	21,169.00	4135
42X30	DFX4230	27,277.00	4375
42X36	DFX4236	35,662.00	5720
42X42	DFX4242	38,376.00	6155
48X12	DFX4812	27,372.00	4390

Contd.....

**CALL FOR BARE/BARE FITTINGS**

### FLANGE CROSS

Contd.....

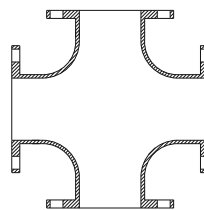

Size (in.)	Item No.	List Price (\$)	Wt. (lb.)
48X14	DFX4814	27,339.00	4385
48X16	DFX4816	27,527.00	4415
48X18	DFX4818	27,558.00	4420
48X20	DFX4820	27,807.00	4460
48X24	DFX4824	28,275.00	4535
48X30	DFX4830	29,116.00	5705
48X36	DFX4836	36,659.00	7310
48X42	DFX4842	47,569.00	7630
48X48	DFX4848	49,908.00	8005
54X12	DFX5412	POA	4575

Size (in.)	Item No.	List Price (\$)	Wt. (lb.)
54X14	DFX5414	POA	4575
54X16	DFX5416	POA	4605
54X18	DFX5418	POA	4625
54X20	DFX5420	POA	4665
54X24	DFX5424	POA	4700
54X30	DFX5430	POA	4800
54X36	DFX5436	POA	4950
54X42	DFX5442	POA	6210
54X48	DFX5448	POA	6425
54X54	DFX5454	POA	6780

### FLANGE LATERAL WYES

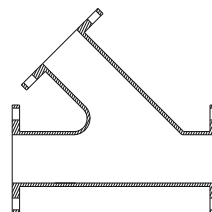

Size (in.)	Item No.	List Price (\$)	Wt. (lb.)
3 X 3	DFY0303	232.00	45
4 X 2	DFY0402	280.00	56
4 X 3	DFY0403	334.00	65
4 X 4	DFY0404	308.00	75
6 X 3	DFY0603	507.00	102
6 X 4	DFY0604	585.00	105
6 X 6	DFY0606	494.00	120
8 X 4	DFY0804	915.00	165
8 X 6	DFY0806	876.00	175
8 X 8	DFY0808	809.00	200
10 X 4	DFY1004	1,319.00	240
10 X 6	DFY1006	1,372.00	250
10 X 8	DFY1008	1,498.00	335
10 X 10	DFY1010	1,299.00	335
12 X 4	DFY1204	1,927.00	350
12 X 6	DFY1206	2,005.00	427
12 X 8	DFY1208	1,978.00	452

Size (in.)	Item No.	List Price (\$)	Wt. (lb.)
12 X 10	DFY1210	2,308.00	420
12 X 12	DFY1212	1,987.00	515
14 X 6	DFY1406	2,637.00	475
14 X 8	DFY1408	2,764.00	500
14 X 10	DFY1410	2,663.00	525
14 X 12	DFY1412	3,143.00	570
14 X 14	DFY1414	3,068.00	605
16 X 6	DFY1606	3,143.00	620
16 X 8	DFY1608	3,598.00	645
16 X 10	DFY1610	3,750.00	675
16 X 12	DFY1612	3,624.00	715
16 X 14	DFY1614	4,207.00	755
16 X 16	DFY1616	4,083.00	805
18 X 6	DFY1806	2,282.00	458
18 X 8	DFY1808	3,169.00	780
18 X 10	DFY1810	4,486.00	810
18 X 12	DFY1812	4,714.00	850

Contd.....

CALL FOR BARE/BARE FITTINGS

**FLANGE LATERAL WYES**

Contd.....

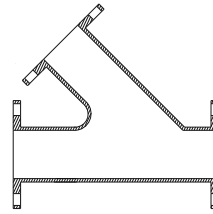

Size (in.)	Item No.	List Price (\$)	Wt. (lb.)
18 X 14	DFY1814	4,943.00	885
18 X 16	DFY1816	5,195.00	935
18 X 18	DFY1818	4,966.00	1035
20 X 8	DFY2008	4,038.00	740
20 X 10	DFY2010	4,395.00	1025
20 X 12	DFY2012	6,059.00	1065
20 X 14	DFY2014	6,632.00	1110
20 X 16	DFY2016	6,930.00	1155
20 X 18	DFY2018	6,548.00	1200
20 X 20	DFY2020	6,904.00	1265
24 X 6	DFY2406	5,785.00	1020
24 X 8	DFY2408	5,894.00	1425
24 X 10	DFY2410	8,213.00	1460
24 X 12	DFY2412	6,548.00	1550
24 X 14	DFY2414	9,548.00	1560
24 X 16	DFY2416	10,312.00	1615
24 X 18	DFY2418	10,124.00	1680
24 X 20	DFY2420	9,548.00	1750
24 X 24	DFY2424	10,395.00	1905
30 X 12	DFY3012	16,339.00	2545
30 X 14	DFY3014	16,662.00	2590
30 X 16	DFY3016	16,982.00	2645
30 X 18	DFY3018	17,303.00	2690
30 X 20	DFY3020	17,769.00	2760
30 X 24	DFY3024	18,735.00	2915
30 X 30	DFY3030	18,852.00	3225
36 X 12	DFY3612	26,246.00	4490
36 X 14	DFY3614	26,567.00	4545

Size (in.)	Item No.	List Price (\$)	Wt. (lb.)
36 X 16	DFY3616	26,043.00	4000
36 X 18	DFY3618	27,298.00	4670
36 X 20	DFY3620	26,743.00	4750
36 X 24	DFY3624	27,619.00	4920
36 X 30	DFY3630	30,394.00	5255
36 X 36	DFY3636	33,550.00	5740
42 X 12	DFY4212	35,693.00	5725
42 X 14	DFY4214	36,160.00	5800
42 X 16	DFY4216	36,472.00	5850
42 X 18	DFY4218	37,408.00	6000
42 X 20	DFY4220	38,095.00	6680
42 X 24	DFY4224	38,998.00	6850
42 X 30	DFY4230	42,740.00	7185
42 X 36	DFY4236	47,696.00	7670
42 X 42	DFY4242	57,170.00	9185
48 X 12	DFY4812	44,889.00	7200
48 X 14	DFY4814	45,357.00	7276
48 X 16	DFY4816	46,136.00	7400
48 X 18	DFY4818	47,507.00	7620
48 X 20	DFY4820	47,912.00	7685
48 X 24	DFY4824	42,646.00	8695
48 X 30	DFY4830	49,970.00	5573
48 X 36	DFY4836	55,924.00	9515
48 X 42	DFY4842	68,642.00	11030
48 X 48	DFY4848	75,437.00	12115
54 X 48	DFY5448	POA	9480
54 X 54	DFY5454	POA	11780
60 X 30	DFY6030	POA	9045

**CALL FOR BARE/BARE FITTINGS**

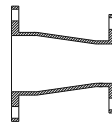
**CONCENTRIC REDUCER**

Size (in.)	Item No.	List Price (\$)	Wt. (lb.)
3 X 2	DFCR0302	85.00	16
3 X 2.5	DFCR0302.5	POA	21
4 X 2	DFCR0402	130.00	25
4 X 2½	DFCR04025	POA	26
4 X 3	DFCR0403	125.00	30
5 X 3	DFCR0503	POA	
5 X 4	DFCR0504	POA	
6 X 2	DFCR0602	179.00	35
6 X 3	DFCR0603	204.00	40
6 X 4	DFCR0604	195.00	45
6 X 5	DFCR0605	259.00	52
8 X 3	DFCR0803	POA	60
8 X 4	DFCR0804	293.00	65
8 X 5	DFCR0805	358.00	70
8 X 6	DFCR0806	318.00	75
10 X 4	DFCR1004	435.00	85
10 X 6	DFCR1006	415.00	90
10 X 8	DFCR1008	518.00	110
12 X 4	DFCR1204	609.00	120
12 X 6	DFCR1206	615.00	130
12 X 8	DFCR1208	687.00	145
12 X 10	DFCR1210	777.00	170
14 X 6	DFCR1406	787.00	155
14 X 8	DFCR1408	889.00	175
14 X 10	DFCR1410	975.00	190
14 X 12	DFCR1412	918.00	248
16 X 6	DFCR1606	967.00	190
16 X 8	DFCR1608	876.00	210
16 X 10	DFCR1610	985.00	235
16 X 12	DFCR1612	1,304.00	265
16 X 14	DFCR1614	1,420.00	280
18 X 8	DFCR1808	1,218.00	240
18 X 10	DFCR1810	1,345.00	265
18 X 12	DFCR1812	1,315.00	295
18 X 14	DFCR1814	1,573.00	310
18 X 16	DFCR1816	1,520.00	340
20 X 6	DFCR2006	1,638.00	306

Size (in.)	Item No.	List Price (\$)	Wt. (lb.)
20 X 8	DFCR2008	1,558.00	295
20 X 10	DFCR2010	1,695.00	310
20 X 12	DFCR2012	1,618.00	345
20 X 14	DFCR2014	1,942.00	355
20 X 16	DFCR2016	1,737.00	390
20 X 18	DFCR2018	2,239.00	410
24 X 8	DFCR2408	2,238.00	410
24 X 10	DFCR2410	2,566.00	472
24 X 12	DFCR2412	2,787.00	480
24 X 14	DFCR2414	2,862.00	490
24 X 16	DFCR2416	2,410.00	525
24 X 18	DFCR2418	3,003.00	550
24 X 20	DFCR2420	3,220.00	590
30 X 12	DFCR3012	4,504.00	825
30 X 14	DFCR3014	POA	
30 X 16	DFCR3016	4,560.00	770
30 X 18	DFCR3018	4,737.00	810
30 X 20	DFCR3020	5,088.00	870
30 X 24	DFCR3024	5,673.00	970
36 X 16	DFCR3616	6,460.00	1105
36 X 18	DFCR3618	6,782.00	1165
36 X 20	DFCR3620	7,192.00	1230
36 X 24	DFCR3624	7,865.00	1345
36 X 30	DFCR3630	9,092.00	1555
42 X 20	DFCR4220	POA	1712
42 X 24	DFCR4224	11,349.00	1820
42 X 30	DFCR4230	12,844.00	2060
42 X 36	DFCR4236	14,622.00	2550
48 X 24	DFCR4824	14,558.00	1350
48 X 30	DFCR4830	16,367.00	2625
48 X 36	DFCR4836	18,394.00	2950
48 X 42	DFCR4842	20,702.00	3320
54X30	DFCR5430	POA	1625
54X36	DFCR5436	POA	1680
54X42	DFCR5442	POA	1800
54X48	DFCR5448	POA	1695

CALL FOR BARE/BARE FITTINGS

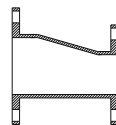

**ECCENTRIC REDUCER**

Size (in.)	Item No.	List Price (\$)	Wt. (lb.)
3 X 2	DFER0302	85.00	16
4 X 2	DFER0402	130.00	25
4 X 3	DFER0403	155.00	30
5 X 4	DFER0504	POA	33
6 X 2	DFER0602	POA	35
6 X 3	DFER0603	204.00	40
6 X 4	DFER0604	232.00	45
6 X 5	DFER0605	266.00	52
8 X 3	DFER0803	POA	60
8 X 4	DFER0804	334.00	65
8 X 5	DFER0805	358.00	70
8 X 6	DFER0806	383.00	75
10 X 4	DFER1004	435.00	85
10 X 6	DFER1006	459.00	90
10 X 8	DFER1008	559.00	110
12 X 4	DFER1204	609.00	120
12 X 6	DFER1206	662.00	130
12 X 8	DFER1208	738.00	145
12 X 10	DFER1210	865.00	170
14 X 6	DFER1406	787.00	155
14 X 8	DFER1408	865.00	175
14 X 10	DFER1410	967.00	190
14 X 12	DFER1412	1,143.00	248
16 X 6	DFER1606	967.00	190
16 X 8	DFER1608	1,066.00	210
16 X 10	DFER1610	1,193.00	235
16 X 12	DFER1612	1,345.00	265
16 X 14	DFER1614	1,420.00	280
18 X 8	DFER1808	1,218.00	240
18 X 10	DFER1810	1,345.00	265
18 X 12	DFER1812	1,498.00	295
18 X 14	DFER1814	1,573.00	310
18 X 16	DFER1816	1,725.00	340
20 X 8	DFER2008	1,584.00	297
20 X 10	DFER2010	1,695.00	310

Size (in.)	Item No.	List Price (\$)	Wt. (lb.)
20 X 12	DFER2012	1,885.00	345
20 X 14	DFER2014	1,942.00	355
20 X 16	DFER2016	2,129.00	390
20 X 18	DFER2018	2,238.00	410
24 X 8	DFER2408	2,513.00	465
24 X 10	DFER2410	2,566.00	473
24 X 12	DFER2412	2,620.00	480
24 X 14	DFER2414	2,675.00	490
24 X 16	DFER2416	2,867.00	525
24 X 18	DFER2418	3,003.00	550
24 X 20	DFER2420	3,220.00	590
30 X 10	DFER3010	4,422.00	760
30 X 14	DFER3014	5,673.00	825
30 X 16	DFER3016	5,468.00	770
30 X 18	DFER3018	4,766.00	810
30 X 20	DFER3020	5,088.00	870
30 X 24	DFER3024	5,673.00	970
36 X 14	DFER3614	7,543.00	1290
36 X 16	DFER3616	6,519.00	1105
36 X 18	DFER3618	6,782.00	1164
36 X 20	DFER3620	7,163.00	1230
36 X 24	DFER3624	7,834.00	1345
36 X 30	DFER3630	9,063.00	1555
42 X 20	DFER4220	POA	1712
42 X 24	DFER4224	11,349.00	1820
42 X 30	DFER4230	12,844.00	2060
42 X 36	DFER4236	14,622.00	2550
48 X 24	DFER4824	15,583.00	2562
48 X 30	DFER4830	16,367.00	2625
48 X 36	DFER4836	18,394.00	2950
48 X 42	DFER4842	20,702.00	3320
54 X 30	DFER5430	POA	1625
54 X 36	DFER5436	POA	1680
54 X 42	DFER5442	POA	1800
54 X 48	DFER5448	POA	1695

**CALL FOR BARE/BARE FITTINGS**

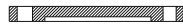
**BLIND FLANGES**

Size (in.)	Item No.	List Price (\$)	Wt. (lb.)
2	DBF02	POA	9
3	DBF03	49.00	9
4	DBF04	86.00	16
6	DBF06	129.00	25
8	DBF08	215.00	42
10	DBF10	322.00	63
12	DBF12	434.00	85
14	DBF14	608.00	120
16	DBF16	738.00	145
18	DBF18	988.00	195
20	DBF20	1,336.00	245
24	DBF24	1,987.00	370
30	DBF30	2,920.00	500
36	DBF36	5,603.00	960
42	DBF42	8,092.00	1300
48	DBF48	10,827.00	1740
54	DBF54	POA	2600

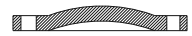
**2" TAPPED  
BLIND FLANGES**

Size (in.)	Item No.	List Price (\$)	Wt. (lb.)
3	DBFT03	88.00	9
4	DBFT04	123.00	16
6	DBFT06	168.00	25
8	DBFT08	254.00	42
10	DBFT10	360.00	63
12	DBFT12	473.00	85
14	DBFT14	670.00	120
16	DBFT16	802.00	145
18	DBFT18	1,066.00	195
20	DBFT20	1,415.00	245
24	DBFT24	2,066.00	370
30	DBFT30	3,036.00	500
36	DBFT36	5,719.00	960
42	DBFT42	8,247.00	1300
48	DBFT48	10,985.00	1740
54	DBFT54	POA	2600

CALL FOR BARE/BARE FITTINGS

# Utility Pipe Fittings Zinc Coated

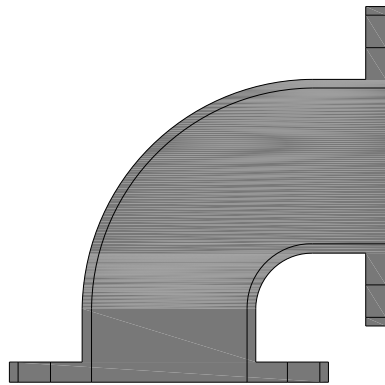

ANSI/AWWA C110/A21.10  
**FLANGE FITTINGS**  
**ZINC COATED**

## **PRICE LIST**

**Effective January 14, 2019.**

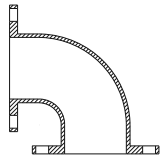

**FLANGE BENDS**  
**90° (1/4)**

Size (in)	Item No.	List Price (\$)	Wt. (lb.)
2	DFB9002Z	120.00	14
3	DFB9003Z	152.00	25
4	DFB9004Z	234.00	45
6	DFB9006Z	362.00	65
8	DFB9008Z	595.00	105
10	DFB9010Z	939.00	165
12	DFB9012Z	1,217.00	235
14	DFB9014Z	1,594.00	290
16	DFB9016Z	1,974.00	370
18	DFB9018Z	2,609.00	450
20	DFB9020Z	3,203.00	580
24	DFB9024Z	5,250.00	900
30	DFB9030Z	9,016.00	1430
36	DFB9036Z	13,362.00	2135
42	DFB9042Z	22,482.00	3055
48	DFB9048Z	30,119.00	4095
54	DFB9054Z	POA	3740

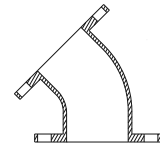
**FLANGE BENDS**  
**45° (1/8)**

Size (in)	Item No.	List Price (\$)	Wt. (lb.)
2	DFB4502Z	123.00	12
3	DFB4503Z	117.00	20
4	DFB4504Z	207.00	40
6	DFB4506Z	320.00	55
8	DFB4508Z	492.00	90
10	DFB4510Z	790.00	130
12	DFB4512Z	1,029.00	195
14	DFB4514Z	1,218.00	220
16	DFB4516Z	1,548.00	280
18	DFB4518Z	2,014.00	325
20	DFB4520Z	2,700.00	430
24	DFB4524Z	3,736.00	630
30	DFB4530Z	7,803.00	1120
36	DFB4536Z	12,227.00	1755
42	DFB4542Z	19,122.00	2600
48	DFB4548Z	26,330.00	3580
54	DFB4554Z	POA	2735

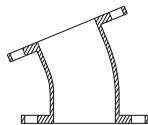
**FLANGE BENDS**  
**22½° (1/16)**

Size (in)	Item No.	List Price (\$)	Wt. (lb.)
2	DFB2202Z	POA	12
3	DFB2203Z	127.00	20
4	DFB2204Z	206.00	40
6	DFB2206Z	307.00	55
8	DFB2208Z	480.00	90
10	DFB2210Z	756.00	135
12	DFB2212Z	1,104.00	205
14	DFB2214Z	1,395.00	225
16	DFB2216Z	1,600.00	285
18	DFB2218Z	2,076.00	335
20	DFB2220Z	2,863.00	435
24	DFB2224Z	4,209.00	640
30	DFB2230Z	7,908.00	1135
36	DFB2236Z	12,470.00	1790
42	DFB2242Z	19,603.00	2665
48	DFB2248Z	26,957.00	3665
54	DFB2254Z	POA	2260

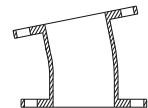
**FLANGE BENDS**  
**11¼° (1/32)**

Size (in)	Item No.	List Price (\$)	Wt. (lb.)
2	DFB1102Z	POA	12
3	DFB1103Z	127.00	20
4	DFB1104Z	240.00	40
6	DFB1106Z	372.00	55
8	DFB1108Z	507.00	90
10	DFB1110Z	838.00	135
12	DFB1112Z	1,273.00	205
14	DFB1114Z	1,450.00	225
16	DFB1116Z	1,767.00	285
18	DFB1118Z	2,076.00	335
20	DFB1120Z	2,863.00	435
24	DFB1124Z	4,425.00	645
30	DFB1130Z	8,013.00	1150
36	DFB1136Z	12,575.00	1805
42	DFB1142Z	19,712.00	2680
48	DFB1148Z	27,177.00	3695
54	DFB1154Z	POA	2100



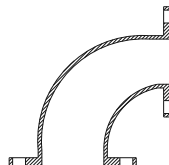

**90° REDUCING BENDS**

Size (in)	Item No.	List Price (\$)	Wt. (lb.)
4 X 3	DFBR0403Z	184.00	35
6 X 3	DFBR0603Z	348.00	45
6 X 4	DFBR0604Z	343.00	55
6 X 5	DFBR0605Z	348.00	
8 X 4	DFBR0804Z	467.00	80
8 X 6	DFBR0806Z	532.00	90
10X 4	DFBR1004Z	807.00	105
10X 6	DFBR1006Z	838.00	125
10X 8	DFBR1008Z	930.00	150
12X 4	DFBR1204Z	868.00	
12X 6	DFBR1206Z	992.00	165
12X 8	DFBR1208Z	1,168.00	190
12X10	DFBR1210Z	1,238.00	220
14X 6	DFBR1406Z	1,179.00	144
14X 8	DFBR1408Z	1,333.00	200
14X10	DFBR1410Z	1,487.00	260
14X12	DFBR1412Z	1,674.00	270
16X 6	DFBR1606Z	POA	220
16X 8	DFBR1608Z	1,487.00	240
16X10	DFBR1610Z	1,735.00	344
16X12	DFBR1612Z	1,920.00	373
16X14	DFBR1614Z	2,076.00	330
18X 6	DFBR1806Z	POA	260
18X 8	DFBR1808Z	POA	280
18X10	DFBR1810Z	2,045.00	320
18X12	DFBR1812Z	2,169.00	465
18X14	DFBR1814Z	2,385.00	370
18X16	DFBR1816Z	2,599.00	410
20X 6	DFBR2006Z	POA	320
20X 8	DFBR2008Z	POA	345
20X10	DFBR2010Z	POA	385
20X12	DFBR2012Z	2,989.00	415
20X14	DFBR2014Z	3,338.00	518
20X16	DFBR2016Z	3,258.00	533
20X18	DFBR2018Z	3,456.00	515
24X 6	DFBR2406Z	POA	480
24X 8	DFBR2408Z	POA	505
24X10	DFBR2410Z	POA	545
24X12	DFBR2412Z	3,784.00	575
24X14	DFBR2414Z	4,178.00	595
24X16	DFBR2416Z	4,507.00	635
24X18	DFBR2418Z	4,549.00	675
24X20	DFBR2420Z	4,867.00	740

Size (in)	Item No.	List Price (\$)	Wt. (lb.)
30X12	DFBR3012Z	5,852.00	840
30X14	DFBR3014Z	7,206.00	860
30X16	DFBR3016Z	6,269.00	900
30X18	DFBR3018Z	9,306.00	940
30X20	DFBR3020Z	9,870.00	1005
30X24	DFBR3024Z	8,396.00	1165
36X12	DFBR3612Z	8,326.00	1195
36X14	DFBR3614Z	10,655.00	1215
36X16	DFBR3616Z	8,745.00	1255
36X18	DFBR3618Z	11,270.00	1295
36X20	DFBR3620Z	11,672.00	1315
36X24	DFBR3624Z	11,043.00	1520
36X30	DFBR3630Z	12,816.00	1785
42X12	DFBR4212Z	POA	1655
42X14	DFBR4214Z	14,802.00	1675
42X16	DFBR4216Z	12,616.00	1715
42X18	DFBR4218Z	16,680.00	1755
42X20	DFBR4220Z	16,503.00	1820
42X24	DFBR4224Z	14,565.00	1980
42X30	DFBR4230Z	17,249.00	2245
42X36	DFBR4236Z	24,934.00	2600
48X12	DFBR4812Z	15,998.00	2175
48X14	DFBR4814Z	19,150.00	2195
48X16	DFBR4816Z	16,440.00	2235
48X18	DFBR4818Z	23,160.00	2275
48X20	DFBR4820Z	25,026.00	2340
48X24	DFBR4824Z	23,830.00	2500
48X30	DFBR4830Z	26,047.00	2765
48X36	DFBR4836Z	26,204.00	3115
48X42	DFBR4842Z	34,457.00	3580
54X12	DFBR5412Z	POA	1990
54X14	DFBR5414Z	POA	2015
54X16	DFBR5416Z	POA	2055
54X18	DFBR5418Z	POA	2095
54X20	DFBR5420Z	POA	2160
54X24	DFBR5424Z	POA	2320
54X30	DFBR5430Z	POA	2585
54X36	DFBR5436Z	POA	2940
54X42	DFBR5442Z	POA	3395
54X48	DFBR5448Z	POA	3565

**90° BASE BENDS**

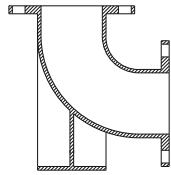

Size (in)	Item No.	List Price (\$)	Wt. (lb.)
3	DFBB9003Z	218.00	35
4	DFBB9004Z	343.00	55
6	DFBB9006Z	503.00	85
8	DFBB9008Z	950.00	145
10	DFBB9010Z	1,302.00	210
12	DFBB9012Z	1,855.00	300
14	DFBB9014Z	2,229.00	320
16	DFBB9016Z	2,756.00	445
18	DFBB9018Z	3,499.00	565
20	DFBB9020Z	4,604.00	700
24	DFBB9024Z	6,775.00	1030
30	DFBB9030Z	11,320.00	1625
36	DFBB9036Z	16,614.00	2385
42	DFBB9042Z	30,753.00	3465
48	DFBB9048Z	33,906.00	4610
54	DFBB9054Z	POA	4415

**90° LONG RADIUS BASE BENDS**

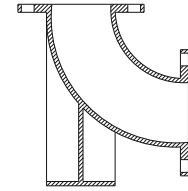

Size (in)	Item No.	List Price (\$)	Wt. (lb.)
3	DFBBLR9003Z	238.00	40
4	DFBBLR9004Z	373.00	60
6	DFBBLR9006Z	619.00	100
8	DFBBLR9008Z	1,116.00	180
10	DFBBLR9010Z	1,627.00	260
12	DFBBLR9012Z	2,552.00	390
14	DFBBLR9014Z	2,583.00	650
16	DFBBLR9016Z	4,579.00	815
18	DFBBLR9018Z	4,950.00	955
20	DFBBLR9020Z	6,479.00	1200
24	DFBBLR9024Z	9,404.00	1770
30	DFBBLR9030Z	16,716.00	2295
36	DFBBLR9036Z	25,632.00	3535
42	DFBBLR9042Z	40,563.00	5275
48	DFBBLR9048Z	56,153.00	7305
54	DFBBLR9054Z	POA	6880

**BASE TEES**

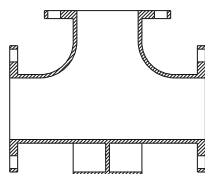

Size (in)	Item No.	List Price (\$)	Wt. (lb.)
3	DFTB0303Z	283.00	45
4	DFTB0404Z	467.00	75
6	DFTB0606Z	683.00	110
8	DFTB0808Z	1,149.00	185
10	DFTB1010Z	1,858.00	300
12	DFTB1212Z	2,662.00	430
14	DFTB1414Z	3,004.00	500
16	DFTB1616Z	3,713.00	600
18	DFTB1818Z	4,579.00	740
20	DFTB2020Z	6,116.00	930
24	DFTB2424Z	9,274.00	1410
30	DFTB3030Z	15,813.00	2270
36	DFTB3636Z	23,124.00	3320
42	DFTB4242Z	43,024.00	5850
48	DFTB4848Z	56,777.00	7720
54	DFTB5454Z	POA	6465

ZINC ZINC

**90° REDUCING BASE BENDS**  
(WITH BASE UNDER SMALL END)

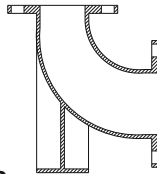

R - Available multiple size reductions.

Size (in)	Item No.	List Price (\$)	Wt. (lb.)
4 X 3	DFBBSDR0403Z	POA	45
6 X 4	DFBBSDR0604Z	POA	75
8 X 4	DFBBSDR0804Z	POA	120
8 X 6	DFBBSDR0806Z	POA	130
10X 6	DFBBSDR1006Z	POA	170
10X 8	DFBBSDR1008Z	POA	195
12X 6	DFBBSDR1206Z	POA	230
12X 8	DFBBSDR1208Z	POA	255
12X10	DFBBSDR1210Z	POA	285
14X R	DFBBSDR14Z	POA	
16X R	DFBBSDR16Z	POA	
18X R	DFBBSDR18Z	POA	
20X R	DFBBSDR20Z	POA	
24X R	DFBBSDR24Z	POA	
30X R	DFBBSDR30Z	POA	
36X R	DFBBSDR36Z	POA	
42X R	DFBBSDR42Z	POA	
48X R	DFBBSDR48Z	POA	
54X R	DFBBSDR54Z	POA	

**90° REDUCING BASE BENDS**  
(WITH BASE UNDER LARGE END)

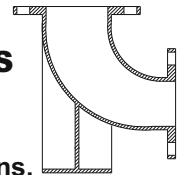

R - Available multiple size reductions.

Size (in)	Item No.	List Price (\$)	Wt. (lb.)
4 X 3	DFBBLDR0403Z	POA	45
6 X 4	DFBBLDR0604Z	POA	75
8 X 4	DFBBLDR0804Z	POA	120
8 X 6	DFBBLDR0806Z	POA	130
10X 6	DFBBLDR1006Z	POA	170
10X 8	DFBBLDR1008Z	POA	195
12X 6	DFBBLDR1206Z	POA	230
12X 8	DFBBLDR1208Z	POA	255
12X10	DFBBLDR1210Z	POA	285
14X R	DFBBLDR14Z	POA	
16X R	DFBBLDR16Z	POA	
18X R	DFBBLDR18Z	POA	
20X R	DFBBLDR20Z	POA	
24X R	DFBBLDR24Z	POA	
30X R	DFBBLDR30Z	POA	
36X R	DFBBLDR36Z	POA	
42X R	DFBBLDR42Z	POA	
48X R	DFBBLDR48Z	POA	
54X R	DFBBLDR54Z	POA	

**TRUE WYES**

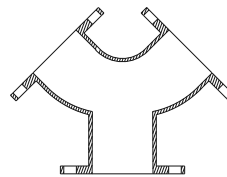

Size (in)	Item No.	List Price (\$)	Wt. (lb.)
4 X 4 X 4	DFYT040404Z	312.00	50
6 X 4 X 4	DFYT060404Z	POA	75
6 X 6 X 6	DFYT060606Z	497.00	80
8 X 6 X 6	DFYT080606Z	POA	120
8 X 8 X 4	DFYT080804Z	POA	
8 X 8 X 8	DFYT080808Z	868.00	125
10 X 10 X 6	DFYT101006Z	POA	
10 X 8 X 8	DFYT100808Z	962.00	155
10 X 10 X 10	DFYT101010Z	1,149.00	185
12 X 12 X 6	DFYT121206Z	POA	
12 X 12 X 8	DFYT121208Z	POA	

Size (in)	Item No.	List Price (\$)	Wt. (lb.)
12 X 12 X 10	DFYT121210Z	POA	
12 X 12 X 12	DFYT121212Z	1,858.00	300
14 X 14 X 14	DFYT141414Z	POA	415
16 X 16 X 16	DFYT161616Z	POA	580
18 X 18 X 18	DFYT181818Z	POA	680
20 X 20 X 20	DFYT202020Z	POA	960
24 X 24 X 24	DFYT242424Z	POA	1370
30 X 30 X 30	DFYT303030Z	POA	80
36 X 36 X 36	DFYT363636Z	POA	120
42 X 42 X 42	DFYT424242Z	POA	125
48 X 48 X 48	DFYT484848Z	POA	120



**FLANGE TEES**

Contd.....

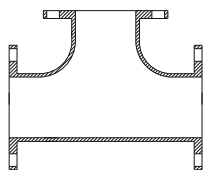

Size (in)	Item No.	List Price (\$)	Wt. (lb.)
36X30	DFT3630Z	20,895.00	3000
36X36	DFT3636Z	19,430.00	3160
42X12	DFT4212Z	23,279.00	3165
42X14	DFT4214Z	23,316.00	3170
42X16	DFT4216Z	23,389.00	3180
42X18	DFT4218Z	23,425.00	3185
42X20	DFT4220Z	23,575.00	3205
42X24	DFT4224Z	23,868.00	3245
42X30	DFT4230Z	30,339.00	4125
42X36	DFT4236Z	39,422.00	5360
42X42	DFT4242Z	41,040.00	5580
48X12	DFT4812Z	31,738.00	4315
48X14	DFT4814Z	31,738.00	4315
48X16	DFT4816Z	31,846.00	4330
48X18	DFT4818Z	31,846.00	4330
48X20	DFT4820Z	31,993.00	4350
48X24	DFT4824Z	32,250.00	4385
48X30	DFT4830Z	32,767.00	4455
48X36	DFT4836Z	40,856.00	7035
48X42	DFT4842Z	52,917.00	7195
48X48	DFT4848Z	54,315.00	7385
54X12	DFT5412Z	POA	4435
54X14	DFT5414Z	POA	4435
54X16	DFT5416Z	POA	4450
54X18	DFT5418Z	POA	4460
54X20	DFT5420Z	POA	4480
54X24	DFT5424Z	POA	4515
54X30	DFT5430Z	POA	4615
54X36	DFT5436Z	POA	4695
54X42	DFT5442Z	POA	5740
54X48	DFT5448Z	POA	5850
54X54	DFT5454Z	POA	6025

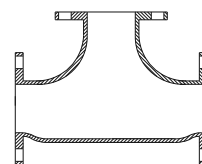
**FLANGE TEES - BULL HEAD**

Size (in)	Item No.	List Price (\$)	Wt. (lb.)
4 X 4 X 6	DFTBH040406Z	754.00	90
6 X 6 X 8	DFTBH060608Z	876.00	140
8 X 8 X 10	DFTBH080810Z	1,610.00	260
8 X 8 X 12	DFTBH080812Z	1,633.00	291
10X10X12	DFTBH101012Z	POA	355

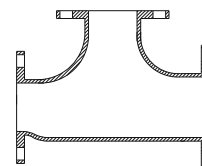
**FLANGE TEES - REDUCING ON THE RUN**

Size (in)	Item No.	List Price (\$)	Wt. (lb.)
4 X 3 X 3	DFTROR040303Z	POA	55
6 X 4 X 4	DFTROR060404Z	559.00	103
6 X 4 X 6	DFTROR060406Z	559.00	108
8 X 6 X 4	DFTROR080604Z	777.00	146
8 X 6 X 6	DFTROR080606Z	900.00	148
8 X 6 X 8	DFTROR080608Z	992.00	145
10X 6 X 6	DFTROR100606Z	1,804.00	275
10X 6 X 10	DFTROR100610Z	1,776.00	305
10X 8 X 6	DFTROR100806Z	1,815.00	280
10X 8 X 8	DFTROR100808Z	1,916.00	302
10X 8 X 10	DFTROR100810Z	1,965.00	325
12X 6 X 6	DFTROR120606Z	2,244.00	340
12X 6 X 8	DFTROR120608Z	2,348.00	360
12X 8 X 6	DFTROR120806Z	2,302.00	355
12X 8 X 8	DFTROR120808Z	2,432.00	375
12X 8 X 12	DFTROR120812Z	2,723.00	420
12X10X 6	DFTROR121006Z	2,248.00	390
12X10X 8	DFTROR121008Z	2,593.00	400
12X10X10	DFTROR121010Z	2,723.00	420
12X10X12	DFTROR121012Z	2,852.00	440

**FLANGE CROSS**

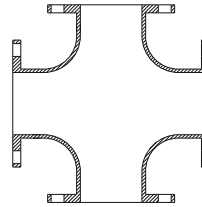

Size (in)	Item No.	List Price (\$)	Wt. (lb.)
3 X 3	DFX0303Z	312.00	50
4 X 3	DFX0403Z	436.00	70
4 X 4	DFX0404Z	449.00	80
6 X 3	DFX0603Z	590.00	95
6 X 4	DFX0604Z	683.00	110
6 X 6	DFX0606Z	726.00	120
8 X 3	DFX0803Z	POA	140
8 X 4	DFX0804Z	962.00	155
8 X 6	DFX0806Z	1,025.00	175
8 X 8	DFX0808Z	1,087.00	195
10X 4	DFX1004Z	1,363.00	220
10X 6	DFX1006Z	1,487.00	240
10X 8	DFX1008Z	1,643.00	265
10X10	DFX1010Z	2,045.00	330
12X 4	DFX1204Z	1,920.00	310
12X 6	DFX1206Z	1,980.00	320
12X 8	DFX1208Z	2,138.00	345
12X10	DFX1210Z	2,570.00	415
12X12	DFX1212Z	2,410.00	460
14X 6	DFX1406Z	2,476.00	400
14X 8	DFX1408Z	2,632.00	425
14X10	DFX1410Z	2,848.00	460
14X12	DFX1412Z	3,128.00	505
14X14	DFX1414Z	3,282.00	530
16X 6	DFX1606Z	3,034.00	490
16X 8	DFX1608Z	3,219.00	520
16X10	DFX1610Z	3,436.00	555
16X12	DFX1612Z	3,747.00	605
16X14	DFX1614Z	POA	620
16X16	DFX1616Z	4,117.00	755
18X 6	DFX1806Z	3,128.00	505
18X 8	DFX1808Z	3,312.00	535
18X10	DFX1810Z	3,467.00	560
18X12	DFX1812Z	3,775.00	610
18X14	DFX1814Z	4,455.00	720
18X16	DFX1816Z	4,736.00	765
18X18	DFX1818Z	4,922.00	795
20X 6	DFX2006Z	4,178.00	635
20X 8	DFX2008Z	4,375.00	665

Size (in)	Item No.	List Price (\$)	Wt. (lb.)
20X10	DFX2010Z	4,507.00	685
20X12	DFX2012Z	4,836.00	735
20X14	DFX2014Z	4,902.00	745
20X16	DFX2016Z	6,019.00	915
20X18	DFX2018Z	6,216.00	945
20X20	DFX2020Z	6,677.00	1015
24X 6	DFX2406Z	5,758.00	875
24X 8	DFX2408Z	5,887.00	895
24X10	DFX2410Z	6,116.00	930
24X12	DFX2412Z	6,314.00	960
24X14	DFX2414Z	6,414.00	975
24X16	DFX2416Z	6,644.00	1010
24X18	DFX2418Z	8,979.00	1365
24X20	DFX2420Z	9,404.00	1430
24X24	DFX2424Z	10,326.00	1570
30X10	DFX3010Z	POA	
30X12	DFX3012Z	10,904.00	1565
30X14	DFX3014Z	10,938.00	1570
30X16	DFX3016Z	11,183.00	1605
30X18	DFX3018Z	11,250.00	1515
30X20	DFX3020Z	11,634.00	1670
30X24	DFX3024Z	15,640.00	2245
30X30	DFX3030Z	17,414.00	2500
36X12	DFX3612Z	15,603.00	2240
36X14	DFX3614Z	15,603.00	2240
36X16	DFX3616Z	15,813.00	2270
36X18	DFX3618Z	15,882.00	2280
36X20	DFX3620Z	16,196.00	2325
36X24	DFX3624Z	16,754.00	2405
36X30	DFX3630Z	22,985.00	3300
36X36	DFX3636Z	25,214.00	3620
42X12	DFX4212Z	23,830.00	3240
42X14	DFX4214Z	23,830.00	3240
42X16	DFX4216Z	24,052.00	3270
42X18	DFX4218Z	24,088.00	3275
42X20	DFX4220Z	24,419.00	3320
42X24	DFX4224Z	24,972.00	4135
42X30	DFX4230Z	32,177.00	4375
42X36	DFX4236Z	42,068.00	5720

Contd.....

ZINC ZINC ZINC ZINC ZINC ZINC ZINC ZINC ZINC ZINC





**FLANGE LATERAL WYES**

Contd.....

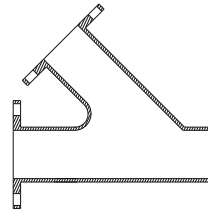

Size (in)	Item No.	List Price (\$)	Wt. (lb.)
18X14	DFY1814Z	6,035.00	885
18X16	DFY1816Z	6,344.00	935
18X18	DFY1818Z	6,064.00	1035
20X 8	DFY2008Z	POA	740
20X10	DFY2010Z	5,297.00	1025
20X12	DFY2012Z	7,303.00	1065
20X14	DFY2014Z	7,993.00	1110
20X16	DFY2016Z	8,353.00	1155
20X18	DFY2018Z	7,892.00	1200
20X20	DFY2020Z	8,322.00	1265
24X 6	DFY2406Z	POA	
24X 8	DFY2408Z	POA	1425
24X10	DFY2410Z	POA	1460
24X12	DFY2412Z	7,892.00	1550
24X14	DFY2414Z	11,508.00	1560
24X16	DFY2416Z	12,428.00	1615
24X18	DFY2418Z	12,202.00	1680
24X20	DFY2420Z	11,508.00	1750
24X24	DFY2424Z	12,529.00	1905
30X12	DFY3012Z	19,470.00	2545
30X14	DFY3014Z	19,854.00	2590
30X16	DFY3016Z	20,236.00	2645
30X18	DFY3018Z	20,618.00	2690
30X20	DFY3020Z	21,174.00	2760
30X24	DFY3024Z	22,325.00	2915
30X30	DFY3030Z	22,465.00	3225
36X12	DFY3612Z	31,275.00	4490
36X14	DFY3614Z	31,658.00	4545
36X16	DFY3616Z	31,033.00	4000
36X18	DFY3618Z	32,528.00	4670

Size (in)	Item No.	List Price (\$)	Wt. (lb.)
36X20	DFY3620Z	31,867.00	4750
36X24	DFY3624Z	32,912.00	4920
36X30	DFY3630Z	36,218.00	5255
36X36	DFY3636Z	39,978.00	5740
42X12	DFY4212Z	42,106.00	5725
42X14	DFY4214Z	42,657.00	5800
42X16	DFY4216Z	43,024.00	5850
42X18	DFY4218Z	44,128.00	6000
42X20	DFY4220Z	44,938.00	6680
42X24	DFY4224Z	46,005.00	6850
42X30	DFY4230Z	50,418.00	7185
42X36	DFY4236Z	56,264.00	7670
42X42	DFY4242Z	67,442.00	9185
48X12	DFY4812Z	52,954.00	7200
48X14	DFY4814Z	53,506.00	7276
48X16	DFY4816Z	54,424.00	7400
48X18	DFY4818Z	56,042.00	7620
48X20	DFY4820Z	56,520.00	7685
48X24	DFY4824Z	50,306.00	8695
48X30	DFY4830Z	58,948.00	5573
48X36	DFY4836Z	65,970.00	9515
48X42	DFY4842Z	80,974.00	11030
48X48	DFY4848Z	88,988.00	12115
54X24	DFY5424Z	POA	6220
54X30	DFY5430Z	POA	7478
54X36	DFY5436Z	POA	7600
54X42	DFY5442Z	POA	8930
54X48	DFY5448Z	POA	9480
54X54	DFY5454Z	POA	11780
60X30	DFY6030Z	POA	9045

ZINC ZINC ZINC ZINC ZINC ZINC ZINC ZINC ZINC ZINC ZINC ZINC

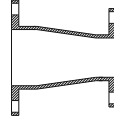
**CONCENTRIC REDUCER**

Size (in)	Item No.	List Price (\$)	Wt. (lb.)
3 X 2	DFCR0302Z	103.00	16
4 X 2	DFCR0402Z	159.00	25
4 X 2.5	DFCR0402.5Z	POA	26
4 X 3	DFCR0403Z	160.00	30
6 X 2	DFCR0602Z	218.00	35
6 X 3	DFCR0603Z	248.00	40
6 X 4	DFCR0604Z	249.00	45
6 X 5	DFCR0605Z	317.00	52
8 X 3	DFCR0803Z	POA	60
8 X 4	DFCR0804Z	374.00	65
8 X 5	DFCR0805Z	436.00	70
8 X 6	DFCR0806Z	408.00	75
10X 4	DFCR1004Z	532.00	85
10X 6	DFCR1006Z	529.00	90
10X 8	DFCR1008Z	662.00	110
12X 4	DFCR1204Z	744.00	120
12X 6	DFCR1206Z	780.00	130
12X 8	DFCR1208Z	872.00	145
12X10	DFCR1210Z	988.00	170
14X 6	DFCR1406Z	962.00	155
14X 8	DFCR1408Z	1,086.00	175
14X10	DFCR1410Z	1,195.00	190
14X12	DFCR1412Z	1,167.00	248
16X 6	DFCR1606Z	1,179.00	190
16X 8	DFCR1608Z	1,114.00	210
16X10	DFCR1610Z	1,253.00	235
16X12	DFCR1612Z	1,607.00	265
16X14	DFCR1614Z	1,735.00	280
18X 8	DFCR1808Z	1,487.00	240
18X10	DFCR1810Z	1,643.00	265
18X12	DFCR1812Z	1,646.00	295
18X14	DFCR1814Z	1,920.00	310
18X16	DFCR1816Z	1,904.00	340
20X 6	DFCR2006Z	POA	

Size (in)	Item No.	List Price (\$)	Wt. (lb.)
20X 8	DFCR2008Z	POA	
20X10	DFCR2010Z	2,042.00	310
20X12	DFCR2012Z	2,027.00	345
20X14	DFCR2014Z	2,339.00	355
20X16	DFCR2016Z	2,175.00	390
20X18	DFCR2018Z	2,700.00	410
24X 8	DFCR2408Z	POA	410
24X10	DFCR2410Z	POA	
24X12	DFCR2412Z	3,359.00	480
24X14	DFCR2414Z	3,449.00	490
24X16	DFCR2416Z	3,007.00	525
24X18	DFCR2418Z	3,618.00	550
24X20	DFCR2420Z	3,882.00	590
30X12	DFCR3012Z	POA	825
30X16	DFCR3016Z	5,434.00	770
30X18	DFCR3018Z	5,645.00	810
30X20	DFCR3020Z	6,063.00	870
30X24	DFCR3024Z	6,759.00	970
36X16	DFCR3616Z	7,699.00	1105
36X18	DFCR3618Z	8,082.00	
36X20	DFCR3620Z	8,569.00	1230
36X24	DFCR3624Z	9,372.00	1345
36X30	DFCR3630Z	10,834.00	1555
42X24	DFCR4224Z	13,387.00	1820
42X30	DFCR4230Z	15,150.00	2060
42X36	DFCR4236Z	17,249.00	2550
48X30	DFCR4830Z	19,307.00	2625
48X36	DFCR4836Z	21,698.00	2950
48X42	DFCR4842Z	24,419.00	3320
54X30	DFCR5430Z	POA	1625
54X36	DFCR5436Z	POA	1680
54X42	DFCR5442Z	POA	1800
54X48	DFCR5448Z	POA	1695

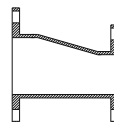
**ECCENTRIC REDUCER**

Size (in)	Item No.	List Price (\$)	Wt. (lb.)
3 X 2	DFER0302Z	POA	16
4 X 2	DFER0402Z	159.00	25
4 X 3	DFER0403Z	189.00	30
6 X 2	DFER0602Z	POA	35
6 X 3	DFER0603Z	248.00	40
6 X 4	DFER0604Z	283.00	45
6 X 5	DFER0605Z	325.00	52
8 X 3	DFER0803Z	POA	60
8 X 4	DFER0804Z	407.00	65
8 X 5	DFER0805Z	436.00	70
8 X 6	DFER0806Z	467.00	75
10X 4	DFER1004Z	532.00	85
10X 6	DFER1006Z	559.00	90
10X 8	DFER1008Z	683.00	110
12X 4	DFER1204Z	744.00	120
12X 6	DFER1206Z	807.00	130
12X 8	DFER1208Z	900.00	145
12X10	DFER1210Z	1,055.00	170
14X 6	DFER1406Z	962.00	155
14X 8	DFER1408Z	1,055.00	175
14X10	DFER1410Z	1,179.00	190
14X12	DFER1412Z	1,395.00	248
16X 6	DFER1606Z	1,179.00	190
16X 8	DFER1608Z	1,302.00	210
16X10	DFER1610Z	1,457.00	235
16X12	DFER1612Z	1,643.00	265
16X14	DFER1614Z	1,735.00	280
18X 8	DFER1808Z	1,487.00	240
18X10	DFER1810Z	1,643.00	265
18X12	DFER1812Z	1,829.00	295
18X14	DFER1814Z	1,920.00	310
18X16	DFER1816Z	2,105.00	340
20X 8	DFER2008Z	POA	
20X10	DFER2010Z	2,042.00	310

Size (in)	Item No.	List Price (\$)	Wt. (lb.)
20X12	DFER2012Z	2,272.00	345
20X14	DFER2014Z	2,339.00	355
20X16	DFER2016Z	2,566.00	390
20X18	DFER2018Z	2,698.00	410
24X 8	DFER2408Z	POA	
24X10	DFER2410Z	POA	
24X12	DFER2412Z	3,158.00	480
24X14	DFER2414Z	3,224.00	490
24X16	DFER2416Z	3,456.00	525
24X18	DFER2418Z	3,618.00	550
24X20	DFER2420Z	3,882.00	590
30X10	DFER3010Z	5,268.00	
30X14	DFER3014Z	6,759.00	825
30X16	DFER3016Z	6,516.00	770
30X18	DFER3018Z	5,679.00	810
30X20	DFER3020Z	6,063.00	870
30X24	DFER3024Z	6,759.00	970
36X14	DFER3614Z	8,987.00	1290
36X16	DFER3616Z	7,769.00	1105
36X18	DFER3618Z	8,082.00	
36X20	DFER3620Z	8,535.00	1230
36X24	DFER3624Z	9,334.00	1345
36X30	DFER3630Z	10,799.00	1555
42X24	DFER4224Z	13,387.00	1820
42X30	DFER4230Z	15,150.00	2060
42X36	DFER4236Z	17,249.00	2550
48X30	DFER4830Z	19,307.00	2625
48X36	DFER4836Z	21,698.00	2950
48X42	DFER4842Z	24,419.00	3320
54X30	DFER5430Z	POA	1625
54X36	DFER5436Z	POA	1680
54X42	DFER5442Z	POA	1800
54X48	DFER5448Z	POA	1695

ZINC ZINC ZINC ZINC ZINC ZINC ZINC ZINC ZINC ZINC ZINC ZINC

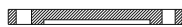
**BLIND FLANGES**

Size (in)	Item No.	List Price (\$)	Wt. (lb.)
2	DBF02Z	POA	9
3	DBF03Z	60.00	9
4	DBF04Z	104.00	16
6	DBF06Z	158.00	25
8	DBF08Z	263.00	42
10	DBF10Z	393.00	63
12	DBF12Z	529.00	85
14	DBF14Z	743.00	120
16	DBF16Z	900.00	145
18	DBF18Z	1,207.00	195
20	DBF20Z	1,610.00	245
24	DBF24Z	2,395.00	370
30	DBF30Z	3,480.00	500
36	DBF36Z	6,676.00	960
42	DBF42Z	9,545.00	1300
48	DBF48Z	12,773.00	1740
54	DBF54Z	POA	2600

**2" TAPPED  
BLIND FLANGES**

Size (in)	Item No.	List Price (\$)	Wt. (lb.)
3	DBFT03Z	99.00	9
4	DBFT04Z	142.00	16
6	DBFT06Z	196.00	25
8	DBFT08Z	300.00	42
10	DBFT10Z	432.00	63
12	DBFT12Z	568.00	85
14	DBFT14Z	805.00	120
16	DBFT16Z	964.00	145
18	DBFT18Z	1,285.00	195
20	DBFT20Z	1,688.00	245
24	DBFT24Z	2,474.00	370
30	DBFT30Z	3,596.00	500
36	DBFT36Z	6,793.00	960
42	DBFT42Z	9,700.00	1300
48	DBFT48Z	12,929.00	1740
54	DBFT54Z	POA	2600

ZINC ZINC

# Utility Pipe Fittings Fusion Bonded Epoxy

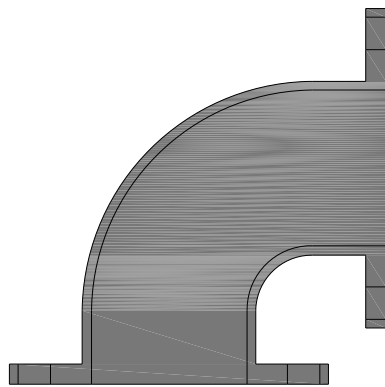

ANSI/AWWA C110/A21.10  
**FLANGE FITTINGS**  
FUSION BONDED EPOXY

**PRICE LIST**  
Effective January 14, 2019.



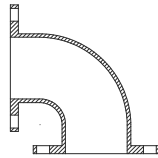

**FLANGE BENDS**  
**90° (1/4)**

Size (in)	Item No.	List Price (\$)	Wt. (lb.)
2	DFB9002E	120.00	14
3	DFB9003E	152.00	25
4	DFB9004E	234.00	45
6	DFB9006E	362.00	65
8	DFB9008E	595.00	105
10	DFB9010E	939.00	165
12	DFB9012E	1,217.00	235
14	DFB9014E	1,594.00	290
16	DFB9016E	1,974.00	370
18	DFB9018E	2,609.00	450
20	DFB9020E	3,203.00	580
24	DFB9024E	5,250.00	900
30	DFB9030E	9,016.00	1430
36	DFB9036E	13,362.00	2135
42	DFB9042E	22,482.00	3055
48	DFB9048E	30,119.00	4095
54	DFB9054E	POA	3740

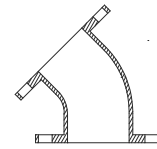
**FLANGE BENDS**  
**45° (1/8)**

Size (in)	Item No.	List Price (\$)	Wt. (lb.)
2	DFB4502E	123.00	12
3	DFB4503E	117.00	20
4	DFB4504E	207.00	40
6	DFB4506E	320.00	55
8	DFB4508E	492.00	90
10	DFB4510E	790.00	130
12	DFB4512E	1,029.00	195
14	DFB4514E	1,218.00	220
16	DFB4516E	1,548.00	280
18	DFB4518E	2,014.00	325
20	DFB4520E	2,700.00	430
24	DFB4524E	3,736.00	630
30	DFB4530E	7,803.00	1120
36	DFB4536E	12,227.00	1755
42	DFB4542E	19,122.00	2600
48	DFB4548E	26,330.00	3580
54	DFB4554E	POA	2735

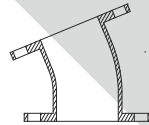
**FLANGE BENDS**  
**22½° (1/16)**

Size (in)	Item No.	List Price (\$)	Wt. (lb.)
2	DFB2202E	162.00	12
3	DFB2203E	127.00	20
4	DFB2204E	206.00	40
6	DFB2206E	307.00	55
8	DFB2208E	480.00	90
10	DFB2210E	756.00	135
12	DFB2212E	1,104.00	205
14	DFB2214E	1,395.00	225
16	DFB2216E	1,600.00	285
18	DFB2218E	2,076.00	335
20	DFB2220E	2,863.00	435
24	DFB2224E	4,209.00	640
30	DFB2230E	7,908.00	1135
36	DFB2236E	12,470.00	1790
42	DFB2242E	19,603.00	2665
48	DFB2248E	26,957.00	3665
54	DFB2254E	POA	2260

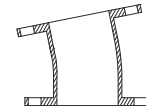
**FLANGE BENDS**  
**11¼° (1/32)**

Size (in)	Item No.	List Price (\$)	Wt. (lb.)
2	DFB1102E	162.00	12
3	DFB1103E	127.00	20
4	DFB1104E	240.00	40
6	DFB1106E	372.00	55
8	DFB1108E	507.00	90
10	DFB1110E	838.00	135
12	DFB1112E	1,273.00	205
14	DFB1114E	1,450.00	225
16	DFB1116E	1,767.00	285
18	DFB1118E	2,076.00	335
20	DFB1120E	2,863.00	435
24	DFB1124E	4,425.00	645
30	DFB1130E	8,013.00	1150
36	DFB1136E	12,575.00	1805
42	DFB1142E	19,712.00	2680
48	DFB1148E	27,177.00	3695
54	DFB1154E	POA	2100

CALL FOR BARE/BARE FITTINGS

**90° LONG RADIUS BENDS**

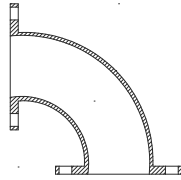

Size (in)	Item No.	List Price (\$)	Wt. (lb.)
3	DFBLR9003E	189.00	30
4	DFBLR9004E	318.00	30
6	DFBLR9006E	547.00	80
8	DFBLR9008E	908.00	140
10	DFBLR9010E	1,333.00	215
12	DFBLR9012E	2,014.00	325
14	DFBLR9014E	2,385.00	580
16	DFBLR9016E	3,128.00	740
18	DFBLR9018E	3,899.00	840
20	DFBLR9020E	5,328.00	928
24	DFBLR9024E	8,155.00	1640
30	DFBLR9030E	14,664.00	2105
36	DFBLR9036E	22,883.00	3285
42	DFBLR9042E	35,783.00	4865
48	DFBLR9048E	49,939.00	7800
54	DFBLR9054E	POA	6205

**90° FLANGE X FLARE BENDS**

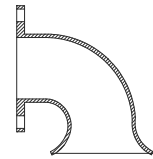

Size (in)	Item No.	List Price (\$)	Wt. (lb.)
3	DFF9003E	159.00	25
4	DFF9004E	283.00	40
6	DFF9006E	436.00	70
8	DFF9008E	744.00	110
10	DFF9010E	1,210.00	175
12	DFF9012E	1,519.00	245
14	DFF9014E	2,105.00	340
16	DFF9016E	2,848.00	460
18	DFF9018E	3,467.00	560
20	DFF9020E	4,604.00	700
24	DFF9024E	6,663.00	1100
30	DFF9030E	13,724.00	1840
36	DFF9036E	19,016.00	2700
42	DFF9042E	23,536.00	3250
48	DFF9048E	38,503.00	4215
54	DFF9054E	POA	3965

**STRAIGHT FLANGE X FLARE**

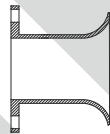

Size (in)	Item No.	List Price (\$)	Wt. (lb.)
3	DFP03E	127.00	20
4	DFP04E	189.00	30
6	DFP06E	248.00	40
8	DFP08E	436.00	70
10	DFP10E	590.00	95
12	DFP12E	962.00	115
14	DFP14E	1,025.00	190
16	DFP16E	1,487.00	330
18	DFP18E	1,705.00	355
20	DFP20E	2,344.00	460
24	DFP24E	3,158.00	635
30	DFP30E	7,663.00	1025
36	DFP36E	10,170.00	1460
42	DFP42E	12,873.00	1900
48	DFP48E	17,469.00	2350
54	DFP54E	POA	2035

**LONG RADIUS 90° FLANGE X FLARE BENDS**

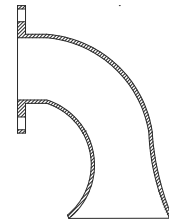

Size (in)	Item No.	List Price (\$)	Wt. (lb.)
3	DFFLR9003E	218.00	30
4	DFFLR9004E	312.00	50
6	DFFLR9006E	559.00	90
8	DFFLR9008E	962.00	115
10	DFFLR9010E	1,550.00	250
12	DFFLR9012E	2,323.00	375
14	DFFLR9014E	3,095.00	500
16	DFFLR9016E	4,425.00	715
18	DFFLR9018E	4,950.00	800
20	DFFLR9020E	7,496.00	1140
24	DFFLR9024E	8,782.00	1335
30	DFFLR9030E	15,255.00	2190
36	DFFLR9036E	24,137.00	3465
42	DFFLR9042E	37,877.00	5150
48	DFFLR9048E	49,460.00	6725

CALL FOR BARE/BARE FITTINGS

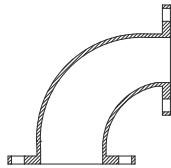
**90° REDUCING BENDS**

Size (in)	Item No.	List Price (\$)	Wt. (lb.)
4 X 3	DFBR0403E	184.00	35
6 X 3	DFBR0603E	348.00	45
6 X 4	DFBR0604E	343.00	55
6 X 5	DFBR0605E	348.00	
8 X 4	DFBR0804E	467.00	80
8 X 6	DFBR0806E	532.00	90
10X 4	DFBR1004E	807.00	105
10X 6	DFBR1006E	838.00	125
10X 8	DFBR1008E	930.00	150
12X 4	DFBR1204E	868.00	
12X 6	DFBR1206E	992.00	165
12X 8	DFBR1208E	1,168.00	190
12X10	DFBR1210E	1,238.00	220
14X 6	DFBR1406E	1,179.00	144
14X 8	DFBR1408E	1,333.00	200
14X10	DFBR1410E	1,487.00	260
14X12	DFBR1412E	1,674.00	270
16X 6	DFBR1606E	1,363.00	220
16X 8	DFBR1608E	1,487.00	240
16X10	DFBR1610E	1,735.00	344
16X12	DFBR1612E	1,920.00	373
16X14	DFBR1614E	2,076.00	330
18X 6	DFBR1806E	1,610.00	260
18X 8	DFBR1808E	2,018.00	280
18X10	DFBR1810E	2,045.00	320
18X12	DFBR1812E	2,169.00	465
18X14	DFBR1814E	2,385.00	370
18X16	DFBR1816E	2,599.00	410
20X 6	DFBR2006E	2,107.00	320
20X 8	DFBR2008E	2,272.00	345
20X10	DFBR2010E	2,929.00	385
20X12	DFBR2012E	2,989.00	415
20X14	DFBR2014E	3,338.00	518
20X16	DFBR2016E	3,258.00	533
20X18	DFBR2018E	3,456.00	515
24X 6	DFBR2406E	3,158.00	480
24X 8	DFBR2408E	3,325.00	505
24X10	DFBR2410E	3,586.00	545
24X12	DFBR2412E	3,784.00	575
24X14	DFBR2414E	4,178.00	595

Size (in)	Item No.	List Price (\$)	Wt. (lb.)
24X16	DFBR2416E	4,507.00	635
24X18	DFBR2418E	4,549.00	675
24X20	DFBR2420E	4,867.00	740
30X12	DFBR3012E	5,852.00	840
30X14	DFBR3014E	7,206.00	860
30X16	DFBR3016E	6,269.00	900
30X18	DFBR3018E	9,306.00	940
30X20	DFBR3020E	9,870.00	1005
30X24	DFBR3024E	8,396.00	1165
36X12	DFBR3612E	8,326.00	1195
36X14	DFBR3614E	10,655.00	1215
36X16	DFBR3616E	8,745.00	1255
36X18	DFBR3618E	11,270.00	1295
36X20	DFBR3620E	11,672.00	1315
36X24	DFBR3624E	11,043.00	1520
36X30	DFBR3630E	12,816.00	1785
42X12	DFBR4212E	POA	1655
42X14	DFBR4214E	14,802.00	1675
42X16	DFBR4216E	12,616.00	1715
42X18	DFBR4218E	16,680.00	1755
42X20	DFBR4220E	16,503.00	1820
42X24	DFBR4224E	14,565.00	1980
42X30	DFBR4230E	17,249.00	2245
42X36	DFBR4236E	24,934.00	2600
48X12	DFBR4812E	15,998.00	2175
48X14	DFBR4814E	19,150.00	2195
48X16	DFBR4816E	16,440.00	2235
48X18	DFBR4818E	23,160.00	2275
48X20	DFBR4820E	25,026.00	2340
48X24	DFBR4824E	23,830.00	2500
48X30	DFBR4830E	26,047.00	2765
48X36	DFBR4836E	26,204.00	3115
48X42	DFBR4842E	34,457.00	3580
54X12	DFBR5412E	POA	1990
54X14	DFBR5414E	POA	2015
54X16	DFBR5416E	POA	2055
54X18	DFBR5418E	POA	2095
54X20	DFBR5420E	POA	2160
54X24	DFBR5424E	POA	2320
54X30	DFBR5430E	POA	2585
54X36	DFBR5436E	POA	2940
54X42	DFBR5442E	POA	3395
54X48	DFBR5448E	POA	3565

CALL FOR BARE/BARE FITTINGS

**90° BASE BENDS**

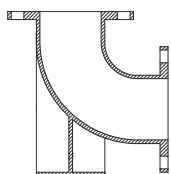

Size (in)	Item No.	List Price (\$)	Wt. (lb.)
3	DFBB9003E	218.00	35
4	DFBB9004E	343.00	55
6	DFBB9006E	503.00	85
8	DFBB9008E	950.00	145
10	DFBB9010E	1,302.00	210
12	DFBB9012E	1,855.00	300
14	DFBB9014E	2,229.00	320
16	DFBB9016E	2,756.00	445
18	DFBB9018E	3,499.00	565
20	DFBB9020E	4,604.00	700
24	DFBB9024E	6,775.00	1030
30	DFBB9030E	11,320.00	1625
36	DFBB9036E	16,614.00	2385
42	DFBB9042E	30,753.00	3465
48	DFBB9048E	33,906.00	4610
54	DFBB9054E	POA	4415

**90° LONG RADIUS BASE BENDS**

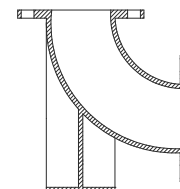

Size (in)	Item No.	List Price (\$)	Wt. (lb.)
3	DFBBLR9003E	238.00	40
4	DFBBLR9004E	373.00	60
6	DFBBLR9006E	619.00	100
8	DFBBLR9008E	1,116.00	180
10	DFBBLR9010E	1,627.00	260
12	DFBBLR9012E	2,552.00	390
14	DFBBLR9014E	2,583.00	650
16	DFBBLR9016E	4,579.00	815
18	DFBBLR9018E	4,950.00	955
20	DFBBLR9020E	6,479.00	1200
24	DFBBLR9024E	9,404.00	1770
30	DFBBLR9030E	16,716.00	2295
36	DFBBLR9036E	25,632.00	3535
42	DFBBLR9042E	40,563.00	5275
48	DFBBLR9048E	56,153.00	7305
54	DFBBLR9054E	POA	6880

**BASE TEES**

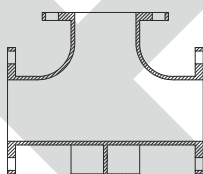

Size (in)	Item No.	List Price (\$)	Wt. (lb.)
3	DFTB0303E	283.00	45
4	DFTB0404E	467.00	75
6	DFTB0606E	683.00	110
8	DFTB0808E	1,149.00	185
10	DFTB1010E	1,858.00	300
12	DFTB1212E	2,662.00	430
14	DFTB1414E	3,004.00	500
16	DFTB1616E	3,713.00	600
18	DFTB1818E	4,579.00	740
20	DFTB2020E	6,116.00	930
24	DFTB2424E	9,274.00	1410
30	DFTB3030E	15,813.00	2270
36	DFTB3636E	23,124.00	3320
42	DFTB4242E	43,024.00	5850
48	DFTB4848E	56,777.00	7720
54	DFTB5454E	POA	6465

CALL FOR BARE/BARE FITTINGS

**90° REDUCING BASE BENDS**

(WITH BASE UNDER SMALL END)

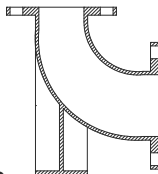

R - Available multiple size reductions.

Size (in)	Item No.	List Price (\$)	Wt. (lb.)
4 X 3	DFBBSDR0403E	POA	45
6 X 4	DFBBSDR0604E	POA	75
8 X 4	DFBBSDR0804E	POA	120
8 X 6	DFBBSDR0806E	POA	130
10X 6	DFBBSDR1006E	POA	170
10X 8	DFBBSDR1008E	POA	195
12X 6	DFBBSDR1206E	POA	230
12X 8	DFBBSDR1208E	POA	255
12X10	DFBBSDR1210E	POA	285
14X R	DFBBSDR14E	POA	
16X R	DFBBSDR16E	POA	
18X R	DFBBSDR18E	POA	
20X R	DFBBSDR20E	POA	
24X R	DFBBSDR24E	POA	
30X R	DFBBSDR30E	POA	
36X R	DFBBSDR36E	POA	
42X R	DFBBSDR42E	POA	
48X R	DFBBSDR48E	POA	
54X R	DFBBSDR54E	POA	

**90° REDUCING BASE BENDS**

(WITH BASE UNDER LARGE END)

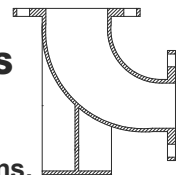

R - Available multiple size reductions.

Size (in)	Item No.	List Price (\$)	Wt. (lb.)
4 X 3	DFBBLDR0403E	POA	45
6 X 4	DFBBLDR0604E	POA	75
8 X 4	DFBBLDR0804E	POA	120
8 X 6	DFBBLDR0806E	POA	130
10X 6	DFBBLDR1006E	POA	170
10X 8	DFBBLDR1008E	POA	195
12X 6	DFBBLDR1206E	POA	230
12X 8	DFBBLDR1208E	POA	255
12X10	DFBBLDR1210E	POA	285
14X R	DFBBLDR14E	POA	
16X R	DFBBLDR16E	POA	
18X R	DFBBLDR18E	POA	
20X R	DFBBLDR20E	POA	
24X R	DFBBLDR24E	POA	
30X R	DFBBLDR30E	POA	
36X R	DFBBLDR36E	POA	
42X R	DFBBLDR42E	POA	
48X R	DFBBLDR48E	POA	
54X R	DFBBLDR54E	POA	

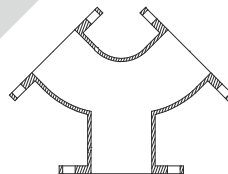
**TRUE WYES**

Size (in)	Item No.	List Price (\$)	Wt. (lb.)
4 X 4 X 4	DFYT0404E	312.00	50
6 X 4 X 4	DFYT060404E	POA	75
6 X 6 X 6	DFYT0606E	497.00	80
8 X 6 X 6	DFYT080606E	POA	120
8 X 8 X 4	DFYT080804E	532.00	
8 X 8 X 8	DFYT0808E	868.00	125
10 X 10 X 6	DFYT101006E	868.00	
10 X 8 X 8	DFYT100808E	962.00	155
10 X 10 X 10	DFYT101010E	1,149.00	185
12 X 12 X 6	DFYT121206E	992.00	
12 X 12 X 8	DFYT121208E	1,302.00	

Size (in)	Item No.	List Price (\$)	Wt. (lb.)
12 X 12 X 10	DFYT121210E	1,487.00	
12 X 12 X 12	DFYT1212E	1,858.00	300
14 X 14 X 14	DFYT1414E	2,570.00	415
16 X 16 X 16	DFYT1616E	3,592.00	580
18 X 18 X 18	DFYT1818E	4,208.00	680
20 X 20 X 20	DFYT2020E	6,314.00	960
24 X 24 X 24	DFYT2424E	9,010.00	1370
30 X 30 X 30	DFYT3030E	POA	80
36 X 36 X 36	DFYT3636E	POA	120
42 X 42 X 42	DFYT4242E	POA	125
48 X 48 X 48	DFYT4848E	POA	120

CALL FOR BARE/BARE FITTINGS



**FLANGE TEES**

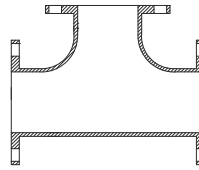

Size (in)	Item No.	List Price (\$)	Wt. (lb.)
2 X 2	DFT0202E	150.00	20
3 X 2	DFT0302E	218.00	35
3 X 3	DFT0303E	215.00	40
4 X 2	DFT0402E	312.00	50
4 X 3	DFT0403E	373.00	60
4 X 4	DFT0404E	407.00	65
5 X 5	DFT0505E	POA	80
6 X 2	DFT0602E	532.00	156
6 X 3	DFT0603E	532.00	85
6 X 4	DFT0604E	559.00	90
6 X 6	DFT0606E	533.00	95
8 X 3	DFT0803E	857.00	130
8 X 4	DFT0804E	824.00	140
8 X 6	DFT0806E	766.00	145
8 X 8	DFT0808E	886.00	155
10X 4	DFT1004E	1,152.00	205
10X 6	DFT1006E	1,099.00	215
10X 8	DFT1008E	1,155.00	225
10X10	DFT1010E	1,342.00	270
12X 4	DFT1204E	1,575.00	290
12X 6	DFT1206E	1,532.00	295
12X 8	DFT1208E	1,614.00	310
12X10	DFT1210E	1,903.00	360
12X12	DFT1212E	1,943.00	385
14X 4	DFT1404E	POA	370
14X 6	DFT1406E	2,323.00	375
14X 8	DFT1408E	2,415.00	390
14X10	DFT1410E	2,476.00	400
14X12	DFT1412E	2,632.00	425
14X14	DFT1414E	2,694.00	435
16X 4	DFT1604E	POA	460
16X 6	DFT1606E	2,709.00	465
16X 8	DFT1608E	2,649.00	475
16X10	DFT1610E	3,046.00	495
16X12	DFT1612E	2,942.00	520
16X14	DFT1614E	3,282.00	530
16X16	DFT1616E	3,036.00	550
18X 6	DFT1806E	2,676.00	480
18X 8	DFT1808E	3,219.00	495
18X10	DFT1810E	3,157.00	510

Size (in)	Item No.	List Price (\$)	Wt. (lb.)
18X12	DFT1812E	3,443.00	535
18X14	DFT1814E	3,837.00	630
18X16	DFT1816E	4,023.00	650
18X18	DFT1818E	3,752.00	785
20X 6	DFT2006E	4,014.00	610
20X 8	DFT2008E	4,079.00	620
20X10	DFT2010E	4,178.00	635
20X12	DFT2012E	4,342.00	660
20X14	DFT2014E	4,375.00	665
20X16	DFT2016E	5,328.00	810
20X18	DFT2018E	5,395.00	820
20X20	DFT2020E	4,747.00	855
24X 4	DFT2404E	5,560.00	
24X 6	DFT2406E	4,802.00	845
24X 8	DFT2408E	5,658.00	860
24X10	DFT2410E	5,789.00	880
24X12	DFT2412E	5,026.00	890
24X14	DFT2414E	5,876.00	900
24X16	DFT2416E	5,150.00	915
24X18	DFT2418E	8,024.00	1220
24X20	DFT2420E	8,255.00	1510
24X24	DFT2424E	7,514.00	1330
30X 6	DFT3006E	10,138.00	1450
30X 8	DFT3008E	10,170.00	
30X10	DFT3010E	10,380.00	
30X12	DFT3012E	10,380.00	1490
30X14	DFT3014E	10,380.00	1490
30X16	DFT3016E	10,485.00	1505
30X18	DFT3018E	10,555.00	1515
30X20	DFT3020E	10,727.00	1540
30X24	DFT3024E	14,107.00	2025
30X30	DFT3030E	13,077.00	2150
36X10	DFT3610E	15,013.00	3082
36X12	DFT3612E	15,117.00	2170
36X14	DFT3614E	15,152.00	2175
36X16	DFT3616E	15,222.00	2185
36X18	DFT3618E	15,255.00	2190
36X20	DFT3620E	15,395.00	2210
36X24	DFT3624E	15,709.00	2255

Contd.....

**CALL FOR BARE/BARE FITTINGS**



**FLANGE TEES**

Contd.....

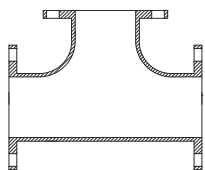

Size (in)	Item No.	List Price (\$)	Wt. (lb.)
36X30	DFT3630E	20,895.00	3000
36X36	DFT3636E	19,430.00	3160
42X12	DFT4212E	23,279.00	3165
42X14	DFT4214E	23,316.00	3170
42X16	DFT4216E	23,389.00	3180
42X18	DFT4218E	23,425.00	3185
42X20	DFT4220E	23,575.00	3205
42X24	DFT4224E	23,868.00	3245
42X30	DFT4230E	30,339.00	4125
42X36	DFT4236E	39,422.00	5360
42X42	DFT4242E	41,040.00	5580
48X12	DFT4812E	31,738.00	4315
48X14	DFT4814E	31,738.00	4315
48X16	DFT4816E	31,846.00	4330
48X18	DFT4818E	31,846.00	4330
48X20	DFT4820E	31,993.00	4350
48X24	DFT4824E	32,250.00	4385
48X30	DFT4830E	32,767.00	4455
48X36	DFT4836E	40,856.00	7035
48X42	DFT4842E	52,917.00	7195
48X48	DFT4848E	54,315.00	7385
54X12	DFT5412E	POA	4435
54X14	DFT5414E	POA	4435
54X16	DFT5416E	POA	4450
54X18	DFT5418E	POA	4460
54X20	DFT5420E	POA	4480
54X24	DFT5424E	POA	4515
54X30	DFT5430E	POA	4615
54X36	DFT5436E	POA	4695
54X42	DFT5442E	POA	5740
54X48	DFT5448E	POA	5850
54X54	DFT5454E	POA	6025

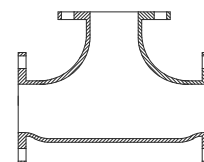
**FLANGE TEES - BULL HEAD**

Size (in)	Item No.	List Price (\$)	Wt. (lb.)
4 X 4 X 6	DFTBH040406E	754.00	90
6 X 6 X 8	DFTBH060608E	876.00	140
8 X 8 X 10	DFTBH080810E	1,610.00	260
8 X 8 X 12	DFTBH080812E	1,633.00	291
10X10X12	DFTBH101012E	2,282.00	355

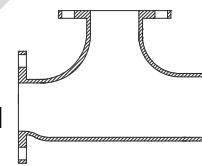
**FLANGE TEES - REDUCING ON THE RUN**

Size (in)	Item No.	List Price (\$)	Wt. (lb.)
4 X 3 X 3	DFTROR040303E	POA	55
6 X 4 X 4	DFTROR060404E	559.00	103
6 X 4 X 6	DFTROR060406E	559.00	108
8 X 6 X 4	DFTROR080604E	777.00	146
8 X 6 X 6	DFTROR080606E	900.00	148
8 X 6 X 8	DFTROR080608E	992.00	145
10X 6 X 6	DFTROR100606E	1,804.00	275
10X 6 X 10	DFTROR100610E	1,776.00	305
10X 8 X 6	DFTROR100806E	1,815.00	280
10X 8 X 8	DFTROR100808E	1,916.00	302
10X 8 X 10	DFTROR100810E	1,965.00	325
12X 6 X 6	DFTROR120606E	2,244.00	340
12X 6 X 8	DFTROR120608E	2,348.00	360
12X 8 X 6	DFTROR120806E	2,302.00	355
12X 8 X 8	DFTROR120808E	2,432.00	375
12X 8 X 12	DFTROR120812E	2,723.00	420
12X10X 6	DFTROR121006E	2,248.00	390
12X10X 8	DFTROR121008E	2,593.00	400
12X10X10	DFTROR121010E	2,723.00	420
12X10X12	DFTROR121012E	2,852.00	440

CALL FOR BARE/BARE FITTINGS

**FLANGE CROSS**

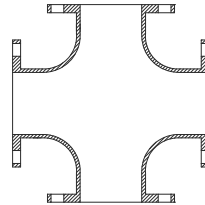

Size (in)	Item No.	List Price (\$)	Wt. (lb.)
3 X 3	DFX0303E	312.00	50
4 X 3	DFX0403E	436.00	70
4 X 4	DFX0404E	449.00	80
6 X 3	DFX0603E	590.00	95
6 X 4	DFX0604E	683.00	110
6 X 6	DFX0606E	726.00	120
8 X 3	DFX0803E	POA	140
8 X 4	DFX0804E	962.00	155
8 X 6	DFX0806E	1,025.00	175
8 X 8	DFX0808E	1,087.00	195
10X 4	DFX1004E	1,363.00	220
10X 6	DFX1006E	1,487.00	240
10X 8	DFX1008E	1,643.00	265
10X10	DFX1010E	2,045.00	330
12X 4	DFX1204E	1,920.00	310
12X 6	DFX1206E	1,980.00	320
12X 8	DFX1208E	2,138.00	345
12X10	DFX1210E	2,570.00	415
12X12	DFX1212E	2,410.00	460
14X 6	DFX1406E	2,476.00	400
14X 8	DFX1408E	2,632.00	425
14X10	DFX1410E	2,848.00	460
14X12	DFX1412E	3,128.00	505
14X14	DFX1414E	3,282.00	530
16X 6	DFX1606E	3,034.00	490
16X 8	DFX1608E	3,219.00	520
16X10	DFX1610E	3,436.00	555
16X12	DFX1612E	3,747.00	605
16X14	DFX1614E	POA	620
16X16	DFX1616E	4,117.00	755
18X 6	DFX1806E	3,128.00	505
18X 8	DFX1808E	3,312.00	535
18X10	DFX1810E	3,467.00	560
18X12	DFX1812E	3,775.00	610
18X14	DFX1814E	4,455.00	720
18X16	DFX1816E	4,736.00	765
18X18	DFX1818E	4,922.00	795
20X 6	DFX2006E	4,178.00	635
20X 8	DFX2008E	4,375.00	665

Size (in)	Item No.	List Price (\$)	Wt. (lb.)
20X10	DFX2010E	4,507.00	685
20X12	DFX2012E	4,836.00	735
20X14	DFX2014E	4,902.00	745
20X16	DFX2016E	6,019.00	915
20X18	DFX2018E	6,216.00	945
20X20	DFX2020E	6,677.00	1015
24X 6	DFX2406E	5,758.00	875
24X 8	DFX2408E	5,887.00	895
24X10	DFX2410E	6,116.00	930
24X12	DFX2412E	6,314.00	960
24X14	DFX2414E	6,414.00	975
24X16	DFX2416E	6,644.00	1010
24X18	DFX2418E	8,979.00	1365
24X20	DFX2420E	9,404.00	1430
24X24	DFX2424E	10,326.00	1570
30X10	DFX3010E	POA	
30X12	DFX3012E	10,904.00	1565
30X14	DFX3014E	10,938.00	1570
30X16	DFX3016E	11,183.00	1605
30X18	DFX3018E	11,250.00	1515
30X20	DFX3020E	11,634.00	1670
30X24	DFX3024E	15,640.00	2245
30X30	DFX3030E	17,414.00	2500
36X12	DFX3612E	15,603.00	2240
36X14	DFX3614E	15,603.00	2240
36X16	DFX3616E	15,813.00	2270
36X18	DFX3618E	15,882.00	2280
36X20	DFX3620E	16,196.00	2325
36X24	DFX3624E	16,754.00	2405
36X30	DFX3630E	22,985.00	3300
36X36	DFX3636E	25,214.00	3620
42X12	DFX4212E	23,830.00	3240
42X14	DFX4214E	23,830.00	3240
42X16	DFX4216E	24,052.00	3270
42X18	DFX4218E	24,088.00	3275
42X20	DFX4220E	24,419.00	3320
42X24	DFX4224E	24,972.00	4135
42X30	DFX4230E	32,177.00	4375
42X36	DFX4236E	42,068.00	5720

Contd.....

CALL FOR BARE/BARE FITTINGS

**FLANGE CROSS**

Contd.....

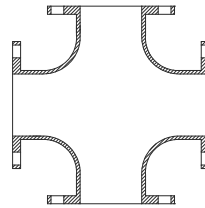

Size (in)	Item No.	List Price (\$)	Wt. (lb.)
42X42	DFX4242E	45,270.00	6155
48X12	DFX4812E	32,288.00	4390
48X14	DFX4814E	32,250.00	4385
48X16	DFX4816E	32,473.00	4415
48X18	DFX4818E	32,508.00	4420
48X20	DFX4820E	32,802.00	4460
48X24	DFX4824E	33,355.00	4535
48X30	DFX4830E	34,346.00	5705
48X36	DFX4836E	43,245.00	7310
48X42	DFX4842E	56,116.00	7630
48X48	DFX4848E	58,875.00	8005

Size (in)	Item No.	List Price (\$)	Wt. (lb.)
54X12	DFX5412E	POA	4575
54X14	DFX5414E	POA	4575
54X16	DFX5416E	POA	4605
54X18	DFX5418E	POA	4625
54X20	DFX5420E	POA	4665
54X24	DFX5424E	POA	4700
54X30	DFX5430E	POA	4800
54X36	DFX5436E	POA	4950
54X42	DFX5442E	POA	6210
54X48	DFX5448E	POA	6425
54X54	DFX5454E	POA	6780

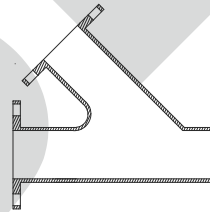
**FLANGE LATERAL WYES**

Size (in)	Item No.	List Price (\$)	Wt. (lb.)
3 X 3	DFY0303E	283.00	45
4 X 2	DFY0402E	343.00	
4 X 3	DFY0403E	407.00	65
4 X 4	DFY0404E	396.00	75
6 X 3	DFY0603E	619.00	
6 X 4	DFY0604E	714.00	105
6 X 6	DFY0606E	633.00	120
8 X 4	DFY0804E	1,116.00	165
8 X 6	DFY0806E	1,078.00	175
8 X 8	DFY0808E	1,037.00	200
10X 4	DFY1004E	1,610.00	240
10X 6	DFY1006E	1,674.00	250
10X 8	DFY1008E	1,829.00	335
10X10	DFY1010E	1,657.00	335
12X 4	DFY1204E	2,353.00	350
12X 6	DFY1206E	2,447.00	427
12X 8	DFY1208E	2,415.00	452

Size (in)	Item No.	List Price (\$)	Wt. (lb.)
12X10	DFY1210E	2,818.00	420
12X12	DFY1212E	2,526.00	515
14X 6	DFY1406E	3,219.00	475
14X 8	DFY1408E	3,375.00	500
14X10	DFY1410E	3,252.00	525
14X12	DFY1412E	3,837.00	570
14X14	DFY1414E	3,747.00	605
16X 6	DFY1606E	3,837.00	620
16X 8	DFY1608E	4,394.00	645
16X10	DFY1610E	4,579.00	675
16X12	DFY1612E	4,425.00	715
16X14	DFY1614E	5,137.00	755
16X16	DFY1616E	4,985.00	805
18X 6	DFY1806E	2,786.00	
18X 8	DFY1808E	3,870.00	780
18X10	DFY1810E	5,478.00	810
18X12	DFY1812E	5,755.00	850

Contd.....

CALL FOR BARE/BARE FITTINGS

**FLANGE LATERAL WYES**

Contd.....

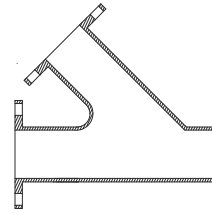

Size (in)	Item No.	List Price (\$)	Wt. (lb.)
18X14	DFY1814E	6,035.00	885
18X16	DFY1816E	6,344.00	935
18X18	DFY1818E	6,064.00	1035
20X 8	DFY2008E	4,867.00	740
20X10	DFY2010E	5,297.00	1025
20X12	DFY2012E	7,303.00	1065
20X14	DFY2014E	7,993.00	1110
20X16	DFY2016E	8,353.00	1155
20X18	DFY2018E	7,892.00	1200
20X20	DFY2020E	8,322.00	1265
24X 6	DFY2406E	6,973.00	
24X 8	DFY2408E	7,103.00	1425
24X10	DFY2410E	9,899.00	1460
24X12	DFY2412E	7,892.00	1550
24X14	DFY2414E	11,508.00	1560
24X16	DFY2416E	12,428.00	1615
24X18	DFY2418E	12,202.00	1680
24X20	DFY2420E	11,508.00	1750
24X24	DFY2424E	12,529.00	1905
30X12	DFY3012E	19,470.00	2545
30X14	DFY3014E	19,854.00	2590
30X16	DFY3016E	20,236.00	2645
30X18	DFY3018E	20,618.00	2690
30X20	DFY3020E	21,174.00	2760
30X24	DFY3024E	22,325.00	2915
30X30	DFY3030E	22,465.00	3225
36X12	DFY3612E	31,275.00	4490
36X14	DFY3614E	31,658.00	4545
36X16	DFY3616E	31,033.00	4000
36X18	DFY3618E	32,528.00	4670

Size (in)	Item No.	List Price (\$)	Wt. (lb.)
36X20	DFY3620E	31,867.00	4750
36X24	DFY3624E	32,912.00	4920
36X30	DFY3630E	36,218.00	5255
36X36	DFY3636E	39,978.00	5740
42X12	DFY4212E	42,106.00	5725
42X14	DFY4214E	42,657.00	5800
42X16	DFY4216E	43,024.00	5850
42X18	DFY4218E	44,128.00	6000
42X20	DFY4220E	44,938.00	6680
42X24	DFY4224E	46,005.00	6850
42X30	DFY4230E	50,418.00	7185
42X36	DFY4236E	56,264.00	7670
42X42	DFY4242E	67,442.00	9185
48X12	DFY4812E	52,954.00	7200
48X14	DFY4814E	53,506.00	7276
48X16	DFY4816E	54,424.00	7400
48X18	DFY4818E	56,042.00	7620
48X20	DFY4820E	56,520.00	7685
48X24	DFY4824E	50,306.00	8695
48X30	DFY4830E	58,948.00	5573
48X36	DFY4836E	65,970.00	9515
48X42	DFY4842E	80,974.00	11030
48X48	DFY4848E	88,988.00	12115
54X24	DFY5424E	POA	6220
54X30	DFY5430E	POA	7478
54X36	DFY5436E	POA	7600
54X42	DFY5442E	POA	8930
54X48	DFY5448E	POA	9480
54X54	DFY5454E	POA	11780
60X30	DFY6030E	POA	9045

CALL FOR BARE/BARE FITTINGS

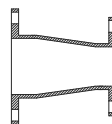
**CONCENTRIC REDUCER**

Size (in)	Item No.	List Price (\$)	Wt. (lb.)
3 X 2	DFCR0302E	103.00	16
4 X 2	DFCR0402E	159.00	25
4 X 2.5	DFCR0402.5E	POA	26
4 X 3	DFCR0403E	160.00	30
6 X 2	DFCR0602E	218.00	35
6 X 3	DFCR0603E	248.00	40
6 X 4	DFCR0604E	249.00	45
6 X 5	DFCR0605E	317.00	52
8 X 3	DFCR0803E	POA	60
8 X 4	DFCR0804E	374.00	65
8 X 5	DFCR0805E	436.00	70
8 X 6	DFCR0806E	408.00	75
10X 4	DFCR1004E	532.00	85
10X 6	DFCR1006E	529.00	90
10X 8	DFCR1008E	662.00	110
12X 4	DFCR1204E	744.00	120
12X 6	DFCR1206E	780.00	130
12X 8	DFCR1208E	872.00	145
12X10	DFCR1210E	988.00	170
14X 6	DFCR1406E	962.00	155
14X 8	DFCR1408E	1,086.00	175
14X10	DFCR1410E	1,195.00	190
14X12	DFCR1412E	1,167.00	248
16X 6	DFCR1606E	1,179.00	190
16X 8	DFCR1608E	1,114.00	210
16X10	DFCR1610E	1,253.00	235
16X12	DFCR1612E	1,607.00	265
16X14	DFCR1614E	1,735.00	280
18X 8	DFCR1808E	1,487.00	240
18X10	DFCR1810E	1,643.00	265
18X12	DFCR1812E	1,646.00	295
18X14	DFCR1814E	1,920.00	310
18X16	DFCR1816E	1,904.00	340
20X 6	DFCR2006E	1,975.00	

Size (in)	Item No.	List Price (\$)	Wt. (lb.)
20X 8	DFCR2008E	1,877.00	
20X10	DFCR2010E	2,042.00	310
20X12	DFCR2012E	2,027.00	345
20X14	DFCR2014E	2,339.00	355
20X16	DFCR2016E	2,175.00	390
20X18	DFCR2018E	2,700.00	410
24X 8	DFCR2408E	2,698.00	410
24X10	DFCR2410E	3,093.00	
24X12	DFCR2412E	3,359.00	480
24X14	DFCR2414E	3,449.00	490
24X16	DFCR2416E	3,007.00	525
24X18	DFCR2418E	3,618.00	550
24X20	DFCR2420E	3,882.00	590
30X12	DFCR3012E	5,366.00	825
30X16	DFCR3016E	5,434.00	770
30X18	DFCR3018E	5,645.00	810
30X20	DFCR3020E	6,063.00	870
30X24	DFCR3024E	6,759.00	970
36X16	DFCR3616E	7,699.00	1105
36X18	DFCR3618E	8,082.00	
36X20	DFCR3620E	8,569.00	1230
36X24	DFCR3624E	9,372.00	1345
36X30	DFCR3630E	10,834.00	1555
42X24	DFCR4224E	13,387.00	1820
42X30	DFCR4230E	15,150.00	2060
42X36	DFCR4236E	17,249.00	2550
48X30	DFCR4830E	19,307.00	2625
48X36	DFCR4836E	21,698.00	2950
48X42	DFCR4842E	24,419.00	3320
54X30	DFCR5430E	POA	1625
54X36	DFCR5436E	POA	1680
54X42	DFCR5442E	POA	1800
54X48	DFCR5448E	POA	1695

CALL FOR BARE/BARE FITTINGS

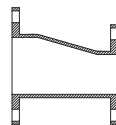

**ECCENTRIC REDUCER**

Size (in)	Item No.	List Price (\$)	Wt. (lb.)
3 X 2	DFER0302E	103.00	16
4 X 2	DFER0402E	159.00	25
4 X 3	DFER0403E	189.00	30
6 X 2	DFER0602E	POA	35
6 X 3	DFER0603E	248.00	40
6 X 4	DFER0604E	283.00	45
6 X 5	DFER0605E	325.00	52
8 X 3	DFER0803E	POA	60
8 X 4	DFER0804E	407.00	65
8 X 5	DFER0805E	436.00	70
8 X 6	DFER0806E	467.00	75
10X 4	DFER1004E	532.00	85
10X 6	DFER1006E	559.00	90
10X 8	DFER1008E	683.00	110
12X 4	DFER1204E	744.00	120
12X 6	DFER1206E	807.00	130
12X 8	DFER1208E	900.00	145
12X10	DFER1210E	1,055.00	170
14X 6	DFER1406E	962.00	155
14X 8	DFER1408E	1,055.00	175
14X10	DFER1410E	1,179.00	190
14X12	DFER1412E	1,395.00	248
16X 6	DFER1606E	1,179.00	190
16X 8	DFER1608E	1,302.00	210
16X10	DFER1610E	1,457.00	235
16X12	DFER1612E	1,643.00	265
16X14	DFER1614E	1,735.00	280
18X 8	DFER1808E	1,487.00	240
18X10	DFER1810E	1,643.00	265
18X12	DFER1812E	1,829.00	295
18X14	DFER1814E	1,920.00	310
18X16	DFER1816E	2,105.00	340
20X 8	DFER2008E	1,908.00	
20X10	DFER2010E	2,042.00	310

Size (in)	Item No.	List Price (\$)	Wt. (lb.)
20X12	DFER2012E	2,272.00	345
20X14	DFER2014E	2,339.00	355
20X16	DFER2016E	2,566.00	390
20X18	DFER2018E	2,698.00	410
24X 8	DFER2408E	3,027.00	
24X10	DFER2410E	3,093.00	
24X12	DFER2412E	3,158.00	480
24X14	DFER2414E	3,224.00	490
24X16	DFER2416E	3,456.00	525
24X18	DFER2418E	3,618.00	550
24X20	DFER2420E	3,882.00	590
30X10	DFER3010E	5,268.00	
30X14	DFER3014E	6,759.00	825
30X16	DFER3016E	6,516.00	770
30X18	DFER3018E	5,679.00	810
30X20	DFER3020E	6,063.00	870
30X24	DFER3024E	6,759.00	970
36X14	DFER3614E	8,987.00	1290
36X16	DFER3616E	7,769.00	1105
36X18	DFER3618E	8,082.00	
36X20	DFER3620E	8,535.00	1230
36X24	DFER3624E	9,334.00	1345
36X30	DFER3630E	10,799.00	1555
42X24	DFER4224E	13,387.00	1820
42X30	DFER4230E	15,150.00	2060
42X36	DFER4236E	17,249.00	2550
48X30	DFER4830E	19,307.00	2625
48X36	DFER4836E	21,698.00	2950
48X42	DFER4842E	24,419.00	3320
54X30	DFER5430E	POA	1625
54X36	DFER5436E	POA	1680
54X42	DFER5442E	POA	1800
54X48	DFER5448E	POA	1695

**CALL FOR BARE/BARE FITTINGS**

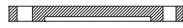

**BLIND FLANGES**

Size (in)	Item No.	List Price (\$)	Wt. (lb.)
2	DBF02E	POA	9
3	DBF03E	60.00	9
4	DBF04E	104.00	16
6	DBF06E	158.00	25
8	DBF08E	263.00	42
10	DBF10E	393.00	63
12	DBF12E	529.00	85
14	DBF14E	743.00	120
16	DBF16E	900.00	145
18	DBF18E	1,207.00	195
20	DBF20E	1,610.00	245
24	DBF24E	2,395.00	370
30	DBF30E	3,480.00	500
36	DBF36E	6,676.00	960
42	DBF42E	9,545.00	1300
48	DBF48E	12,773.00	1740
54	DBF54E	POA	2600

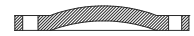
**2" TAPPED  
BLIND FLANGES**

Size (in)	Item No.	List Price (\$)	Wt. (lb.)
3	DBFT03E	99.00	9
4	DBFT04E	142.00	16
6	DBFT06E	196.00	25
8	DBFT08E	300.00	42
10	DBFT10E	432.00	63
12	DBFT12E	568.00	85
14	DBFT14E	805.00	120
16	DBFT16E	964.00	145
18	DBFT18E	1,285.00	195
20	DBFT20E	1,688.00	245
24	DBFT24E	2,474.00	370
30	DBFT30E	3,596.00	500
36	DBFT36E	6,793.00	960
42	DBFT42E	9,700.00	1300
48	DBFT48E	12,929.00	1740
54	DBFT54E	POA	2600

CALL FOR BARE/BARE FITTINGS

# Utility Pipe Fittings Ceramic Epoxy (P401)

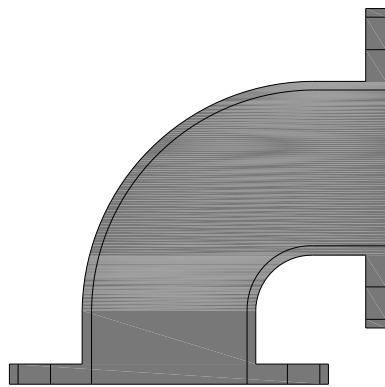

ANSI/AWWA C110/A21.10  
**FLANGE FITTINGS**  
CERAMIC EPOXY (P401) LINED

## PRICE LIST

Effective January 14, 2019.

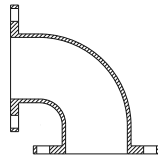

**FLANGE BENDS**  
**90° (1/4)**

Size (in)	Item No.	List Price (\$)	Wt. (lb.)
2	DFB9002P401	POA	14
3	DFB9003P401	505.00	25
4	DFB9004P401	505.00	45
6	DFB9006P401	773.00	65
8	DFB9008P401	1,171.00	105
10	DFB9010P401	1,716.00	165
12	DFB9012P401	2,184.00	235
14	DFB9014P401	2,733.00	290
16	DFB9016P401	3,353.00	370
18	DFB9018P401	4,233.00	450
20	DFB9020P401	5,151.00	580
24	DFB9024P401	7,934.00	900
30	DFB9030P401	12,510.00	1430
36	DFB9036P401	18,950.00	2135
42	DFB9042P401	33,071.00	3055
48	DFB9048P401	43,889.00	4095
54	DFB9054P401	POA	3740

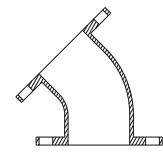
**FLANGE BENDS**  
**45° (1/8)**

Size (in)	Item No.	List Price (\$)	Wt. (lb.)
2	DFB4502P401	POA	12
3	DFB4503P401	471.00	20
4	DFB4504P401	471.00	40
6	DFB4506P401	719.00	55
8	DFB4508P401	1,040.00	90
10	DFB4510P401	1,527.00	130
12	DFB4512P401	1,940.00	195
14	DFB4514P401	2,290.00	220
16	DFB4516P401	2,813.00	280
18	DFB4518P401	3,618.00	325
20	DFB4520P401	4,548.00	430
24	DFB4524P401	6,111.00	630
30	DFB4530P401	12,186.00	1120
36	DFB4536P401	18,518.00	1755
42	DFB4542P401	28,475.00	2600
48	DFB4548P401	38,690.00	3580
54	DFB4554P401	POA	2735

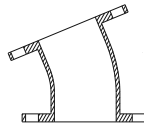
**FLANGE BENDS**  
**22½° (1/16)**

Size (in)	Item No.	List Price (\$)	Wt. (lb.)
2	DFB2202P401	POA	12
3	DFB2203P401	470.00	20
4	DFB2204P401	470.00	40
6	DFB2206P401	701.00	55
8	DFB2208P401	1,029.00	90
10	DFB2210P401	1,483.00	135
12	DFB2212P401	2,038.00	205
14	DFB2214P401	2,588.00	225
16	DFB2216P401	2,881.00	285
18	DFB2218P401	3,700.00	335
20	DFB2220P401	4,901.00	435
24	DFB2224P401	6,922.00	640
30	DFB2230P401	12,329.00	1135
36	DFB2236P401	18,847.00	1790
42	DFB2242P401	29,131.00	2665
48	DFB2248P401	39,547.00	3665
54	DFB2254P401	POA	2260

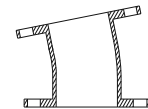
**FLANGE BENDS**  
**11¼° (1/32)**

Size (in)	Item No.	List Price (\$)	Wt. (lb.)
2	DFB1102P401	POA	12
3	DFB1103P401	526.00	20
4	DFB1104P401	526.00	40
6	DFB1106P401	805.00	55
8	DFB1108P401	1,071.00	90
10	DFB1110P401	1,635.00	135
12	DFB1112P401	2,318.00	205
14	DFB1114P401	2,659.00	225
16	DFB1116P401	3,185.00	285
18	DFB1118P401	3,700.00	335
20	DFB1120P401	4,901.00	435
24	DFB1124P401	7,210.00	645
30	DFB1130P401	12,471.00	1150
36	DFB1136P401	18,991.00	1805
42	DFB1142P401	29,282.00	2680
48	DFB1148P401	39,851.00	3695
54	DFB1154P401	POA	2100

P 4 0 1 P 4 0 1 P 4 0 1 P 4 0 1 P 4 0 1 P 4 0 1 P 4 0 1 P 4 0 1 P 4 0 1 P 4 0 1

**90° LONG RADIUS BENDS**

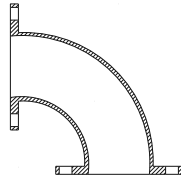

Size (in)	Item No.	List Price (\$)	Wt. (lb.)
3	DFBLR9003P401	484.00	30
4	DFBLR9004P401	704.00	30
6	DFBLR9006P401	1,140.00	80
8	DFBLR9008P401	1,902.00	140
10	DFBLR9010P401	2,664.00	215
12	DFBLR9012P401	4,058.00	325
14	DFBLR9014P401	4,165.00	580
16	DFBLR9016P401	6,917.00	740
18	DFBLR9018P401	7,515.00	840
20	DFBLR9020P401	9,762.00	928
24	DFBLR9024P401	13,904.00	1640
30	DFBLR9030P401	24,307.00	2105
36	DFBLR9036P401	36,745.00	3285
42	DFBLR9042P401	61,874.00	4865
48	DFBLR9048P401	85,172.00	7800
54	DFBLR9054P401	POA	6205

**90° FLANGE X FLARE BENDS**

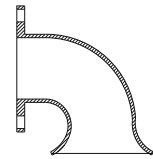

Size (in)	Item No.	List Price (\$)	Wt. (lb.)
3	DFF9003P401	506.00	25
4	DFF9004P401	582.00	40
6	DFF9006P401	893.00	70
8	DFF9008P401	1,410.00	110
10	DFF9010P401	2,129.00	175
12	DFF9012P401	2,646.00	245
14	DFF9014P401	3,531.00	340
16	DFF9016P401	4,619.00	460
18	DFF9018P401	5,547.00	560
20	DFF9020P401	7,242.00	700
24	DFF9024P401	10,061.00	1100
30	DFF9030P401	20,238.00	1840
36	DFF9036P401	27,749.00	2700
42	DFF9042P401	34,534.00	3250
48	DFF9048P401	55,405.00	4215
54	DFF9054P401	POA	3965

**STRAIGHT FLANGE X FLARE**

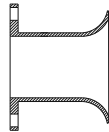

Size (in)	Item No.	List Price (\$)	Wt. (lb.)
3	DFP03P401	POA	20
4	DFP04P401	460.00	30
6	DFP06P401	645.00	40
8	DFP08P401	1,001.00	70
10	DFP10P401	1,308.00	95
12	DFP12P401	1,907.00	115
14	DFP14P401	2,097.00	190
16	DFP16P401	2,813.00	330
18	DFP18P401	3,208.00	355
20	DFP20P401	4,204.00	460
24	DFP24P401	5,509.00	635
30	DFP30P401	12,251.00	1025
36	DFP36P401	POA	1460
42	DFP42P401	POA	1900
48	DFP48P401	POA	2350
54	DFP54P401	POA	2035

**LONG RADIUS 90° FLANGE X FLARE BENDS**

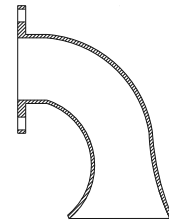

Size (in)	Item No.	List Price (\$)	Wt. (lb.)
3	DFFLR9003P401	POA	30
4	DFFLR9004P401	POA	50
6	DFFLR9006P401	1,646.00	90
8	DFFLR9008P401	2,656.00	115
10	DFFLR9010P401	4,074.00	250
12	DFFLR9012P401	5,891.00	375
14	DFFLR9014P401	7,706.00	500
16	DFFLR9016P401	10,734.00	715
18	DFFLR9018P401	12,016.00	800
20	DFFLR9020P401	17,889.00	1140
24	DFFLR9024P401	20,993.00	1335
30	DFFLR9030P401	36,018.00	2190
36	DFFLR9036P401	56,154.00	3465
42	DFFLR9042P401	55,704.00	5150
48	DFFLR9048P401	72,292.00	6725

P401  
P401  
P401  
P401  
P401  
P401  
P401  
P401

## 90° REDUCING BENDS

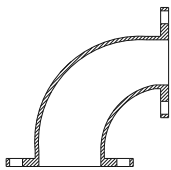

Size (in)	Item No.	List Price (\$)	Wt. (lb.)
4 X 3	DFBR0403P401	450.00	35
6 X 3	DFBR0603P401	779.00	45
6 X 4	DFBR0604P401	770.00	55
6 X 5	DFBR0605P401	POA	
8 X 4	DFBR0804P401	1,040.00	80
8 X 6	DFBR0806P401	1,122.00	90
10X 4	DFBR1004P401	1,625.00	105
10X 6	DFBR1006P401	1,635.00	125
10X 8	DFBR1008P401	1,760.00	150
12X 4	DFBR1204P401	POA	
12X 6	DFBR1206P401	1,946.00	165
12X 8	DFBR1208P401	2,193.00	190
12X10	DFBR1210P401	2,276.00	220
14X 6	DFBR1406P401	2,299.00	144
14X 8	DFBR1408P401	2,507.00	200
14X10	DFBR1410P401	2,709.00	260
14X12	DFBR1412P401	2,957.00	270
16X 6	DFBR1606P401	POA	220
16X 8	DFBR1608P401	2,813.00	240
16X10	DFBR1610P401	3,141.00	344
16X12	DFBR1612P401	3,391.00	373
16X14	DFBR1614P401	3,593.00	330
18X 6	DFBR1806P401	POA	260
18X 8	DFBR1808P401	POA	280
18X10	DFBR1810P401	3,659.00	320
18X12	DFBR1812P401	3,824.00	465
18X14	DFBR1814P401	4,112.00	370
18X16	DFBR1816P401	4,397.00	410
20X 6	DFBR2006P401	POA	320
20X 8	DFBR2008P401	POA	345
20X10	DFBR2010P401	POA	385
20X12	DFBR2012P401	5,140.00	415
20X14	DFBR2014P401	5,635.00	518
20X16	DFBR2016P401	5,431.00	533
20X18	DFBR2018P401	5,695.00	515
24X 6	DFBR2406P401	POA	480
24X 8	DFBR2408P401	POA	505
24X10	DFBR2410P401	POA	545
24X12	DFBR2412P401	6,350.00	575
24X14	DFBR2414P401	6,879.00	595
24X16	DFBR2416P401	7,323.00	635

Size (in)	Item No.	List Price (\$)	Wt. (lb.)
24X18	DFBR2418P401	7,410.00	675
24X20	DFBR2420P401	7,806.00	740
30X12	DFBR3012P401	9,534.00	840
30X14	DFBR3014P401	18,117.00	860
30X16	DFBR3016P401	10,103.00	900
30X18	DFBR3018P401	17,606.00	940
30X20	DFBR3020P401	18,829.00	1005
30X24	DFBR3024P401	12,993.00	1165
36X12	DFBR3612P401	12,120.00	1195
36X14	DFBR3614P401	16,121.00	1215
36X16	DFBR3616P401	12,729.00	1255
36X18	DFBR3618P401	17,035.00	1295
36X20	DFBR3620P401	17,604.00	1315
36X24	DFBR3624P401	16,906.00	1520
36X30	DFBR3630P401	19,321.00	1785
42X12	DFBR4212P401	POA	1655
42X14	DFBR4214P401	22,422.00	1675
42X16	DFBR4216P401	18,551.00	1715
42X18	DFBR4218P401	25,526.00	1755
42X20	DFBR4220P401	24,944.00	1820
42X24	DFBR4224P401	21,420.00	1980
42X30	DFBR4230P401	25,898.00	2245
42X36	DFBR4236P401	37,494.00	2600
48X12	DFBR4812P401	24,055.00	2175
48X14	DFBR4814P401	29,606.00	2195
48X16	DFBR4816P401	24,719.00	2235
48X18	DFBR4818P401	36,560.00	2275
48X20	DFBR4820P401	39,742.00	2340
48X24	DFBR4824P401	34,946.00	2500
48X30	DFBR4830P401	38,931.00	2765
48X36	DFBR4836P401	40,014.00	3115
48X42	DFBR4842P401	47,357.00	3580
54X12	DFBR5412P401	POA	1990
54X14	DFBR5414P401	POA	2015
54X16	DFBR5416P401	POA	2055
54X18	DFBR5418P401	POA	2095
54X20	DFBR5420P401	POA	2160
54X24	DFBR5424P401	POA	2320
54X30	DFBR5430P401	POA	2585
54X36	DFBR5436P401	POA	2940
54X42	DFBR5442P401	POA	3395
54X48	DFBR5448P401	POA	3565

**90° BASE BENDS**

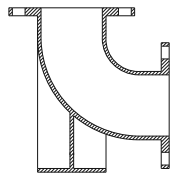

Size (in)	Item No.	List Price (\$)	Wt. (lb.)
3	DFBB9003P401	664.00	35
4	DFBB9004P401	664.00	55
6	DFBB9006P401	957.00	85
8	DFBB9008P401	1,670.00	145
10	DFBB9010P401	2,252.00	210
12	DFBB9012P401	3,086.00	300
14	DFBB9014P401	3,695.00	320
16	DFBB9016P401	4,497.00	445
18	DFBB9018P401	5,590.00	565
20	DFBB9020P401	7,242.00	700
24	DFBB9024P401	10,369.00	1030
30	DFBB9030P401	16,969.00	1625
36	DFBB9036P401	24,482.00	2385
42	DFBB9042P401	43,886.00	3465
48	DFBB9048P401	49,091.00	4610
54	DFBB9054P401	POA	4415

**90° LONG RADIUS BASE BENDS**

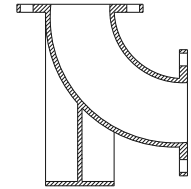

Size (in)	Item No.	List Price (\$)	Wt. (lb.)
3	DFBBLR9003P401	484.00	40
4	DFBBLR9004P401	704.00	60
6	DFBBLR9006P401	1,140.00	100
8	DFBBLR9008P401	1,902.00	180
10	DFBBLR9010P401	2,664.00	260
12	DFBBLR9012P401	4,058.00	390
14	DFBBLR9014P401	4,165.00	650
16	DFBBLR9016P401	6,917.00	815
18	DFBBLR9018P401	7,515.00	955
20	DFBBLR9020P401	9,762.00	1200
24	DFBBLR9024P401	13,904.00	1770
30	DFBBLR9030P401	24,307.00	2295
36	DFBBLR9036P401	36,745.00	3535
42	DFBBLR9042P401	61,874.00	5275
48	DFBBLR9048P401	85,172.00	7305
54	DFBBLR9054P401	POA	6880

**BASE TEES**

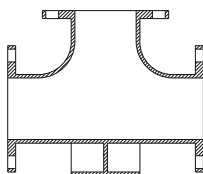

Size (in)	Item No.	List Price (\$)	Wt. (lb.)
3	DFTB0303P401	544.00	45
4	DFTB0404P401	829.00	75
6	DFTB0606P401	1,225.00	110
8	DFTB0808P401	1,945.00	185
10	DFTB1010P401	2,990.00	300
12	DFTB1212P401	4,165.00	430
14	DFTB1414P401	4,723.00	500
16	DFTB1616P401	5,768.00	600
18	DFTB1818P401	7,022.00	740
20	DFTB2020P401	9,276.00	930
24	DFTB2424P401	13,728.00	1410
30	DFTB3030P401	23,077.00	2270
36	DFTB3636P401	33,334.00	3320
42	DFTB4242P401	65,509.00	5850
48	DFTB4848P401	86,096.00	7720
54	DFTB5454P401	POA	6465

P 4 0 1 P 4 0 1 P 4 0 1 P 4 0 1 P 4 0 1 P 4 0 1 P 4 0 1 P 4 0 1 P 4 0 1 P 4 0 1



P401 P401

**90° REDUCING BASE BENDS**

(WITH BASE UNDER SMALL END)

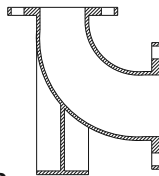

R - Available multiple size reductions.

Size (in)	Item No.	List Price (\$)	Wt. (lb.)
4 X 3	DFBBSDR0403P401	POA	45
6 X 4	DFBBSDR0604P401	POA	75
8 X 4	DFBBSDR0804P401	POA	120
8 X 6	DFBBSDR0806P401	POA	130
10X 6	DFBBSDR1006P401	POA	170
10X 8	DFBBSDR1008P401	POA	195
12X 6	DFBBSDR1206P401	POA	230
12X 8	DFBBSDR1208P401	POA	255
12X10	DFBBSDR1210P401	POA	285
14X R	DFBBSDR14P401	POA	
16X R	DFBBSDR16P401	POA	
18X R	DFBBSDR18P401	POA	
20X R	DFBBSDR20P401	POA	
24X R	DFBBSDR24P401	POA	
30X R	DFBBSDR30P401	POA	
36X R	DFBBSDR36P401	POA	
42X R	DFBBSDR42P401	POA	
48X R	DFBBSDR48P401	POA	
54X R	DFBBSDR54P401	POA	

**90° REDUCING BASE BENDS**

(WITH BASE UNDER LARGE END)

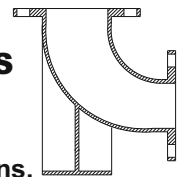

R - Available multiple size reductions.

Size (in)	Item No.	List Price (\$)	Wt. (lb.)
4 X 3	DFBBLDR0403P401	POA	45
6 X 4	DFBBLDR0604P401	POA	75
8 X 4	DFBBLDR0804P401	POA	120
8 X 6	DFBBLDR0806P401	POA	130
10X 6	DFBBLDR1006P401	POA	170
10X 8	DFBBLDR1008P401	POA	195
12X 6	DFBBLDR1206P401	POA	230
12X 8	DFBBLDR1208P401	POA	255
12X10	DFBBLDR1210P401	POA	285
14X R	DFBBLDR14P401	POA	
16X R	DFBBLDR16P401	POA	
18X R	DFBBLDR18P401	POA	
20X R	DFBBLDR20P401	POA	
24X R	DFBBLDR24P401	POA	
30X R	DFBBLDR30P401	POA	
36X R	DFBBLDR36P401	POA	
42X R	DFBBLDR42P401	POA	
48X R	DFBBLDR48P401	POA	
54X R	DFBBLDR54P401	POA	

**TRUE WYES**

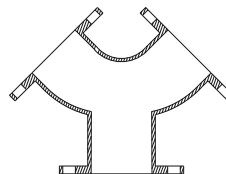

Size (in)	Item No.	List Price (\$)	Wt. (lb.)
4 X 4 X 4	DFYT040404P401	624.00	50
6 X 4 X 4	DFYT060404P401	777.00	75
6 X 6 X 6	DFYT060606P401	975.00	80
8 X 6 X 6	DFYT080606P401	1,196.00	120
8 X 8 X 4	DFYT080804P401	POA	
8 X 8 X 8	DFYT080808P401	1,575.00	125
10 X 10 X 6	DFYT101006P401	POA	
10 X 8 X 8	DFYT100808P401	1,846.00	155
10 X 10 X 10	DFYT101010P401	2,191.00	185
12 X 12 X 6	DFYT121206P401	POA	
12 X 12 X 8	DFYT121208P401	POA	

Size (in)	Item No.	List Price (\$)	Wt. (lb.)
12 X 12 X 10	DFYT121210P401	POA	
12 X 12 X 12	DFYT121212P401	3,463.00	300
14 X 14 X 14	DFYT141414P401	POA	415
16 X 16 X 16	DFYT161616P401	POA	580
18 X 18 X 18	DFYT181818P401	POA	680
20 X 20 X 20	DFYT202020P401	POA	960
24 X 24 X 24	DFYT242424P401	POA	1370
30 X 30 X 30	DFYT303030P401	POA	80
36 X 36 X 36	DFYT363636P401	POA	120
42 X 42 X 42	DFYT424242P401	POA	125
48 X 48 X 48	DFYT484848P401	POA	120

**FLANGE TEES**

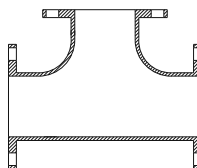

Size (in)	Item No.	List Price (\$)	Wt. (lb.)
2 X 2	DFT0202P401	POA	20
3 X 2	DFT0302P401	POA	35
3 X 3	DFT0303P401	747.00	40
4 X 2	DFT0402P401	POA	50
4 X 3	DFT0403P401	722.00	60
4 X 4	DFT0404P401	747.00	65
5 X 5	DFT0505P401	POA	80
6 X 2	DFT0602P401	POA	156
6 X 3	DFT0603P401	1,041.00	85
6 X 4	DFT0604P401	1,058.00	90
6 X 6	DFT0606P401	985.00	95
8 X 3	DFT0803P401	1,600.00	130
8 X 4	DFT0804P401	1,461.00	140
8 X 6	DFT0806P401	1,391.00	145
8 X 8	DFT0808P401	1,540.00	155
10X 4	DFT1004P401	2,021.00	205
10X 6	DFT1006P401	1,918.00	215
10X 8	DFT1008P401	1,989.00	225
10X10	DFT1010P401	2,226.00	270
12X 4	DFT1204P401	2,664.00	290
12X 6	DFT1206P401	2,583.00	295
12X 8	DFT1208P401	2,688.00	310
12X10	DFT1210P401	3,085.00	360
12X12	DFT1212P401	3,105.00	385
14X 4	DFT1404P401	3,965.00	370
14X 6	DFT1406P401	3,817.00	375
14X 8	DFT1408P401	3,942.00	390
14X10	DFT1410P401	4,024.00	400
14X12	DFT1412P401	4,230.00	425
14X14	DFT1414P401	4,310.00	435
16X 4	DFT1604P401	4,821.00	460
16X 6	DFT1606P401	3,942.00	465
16X 8	DFT1608P401	4,018.00	475
16X10	DFT1610P401	4,872.00	495
16X12	DFT1612P401	4,268.00	520
16X14	DFT1614P401	5,195.00	530
16X16	DFT1616P401	4,548.00	550
18X 6	DFT1806P401	4,410.00	480
18X 8	DFT1808P401	5,264.00	495
18X10	DFT1810P401	5,139.00	510

Size (in)	Item No.	List Price (\$)	Wt. (lb.)
18X12	DFT1812P401	4,790.00	535
18X14	DFT1814P401	6,039.00	630
18X16	DFT1816P401	6,286.00	650
18X18	DFT1818P401	5,725.00	785
20X 6	DFT2006P401	6,448.00	610
20X 8	DFT2008P401	6,536.00	620
20X10	DFT2010P401	6,669.00	635
20X12	DFT2012P401	6,891.00	660
20X14	DFT2014P401	6,935.00	665
20X16	DFT2016P401	8,216.00	810
20X18	DFT2018P401	8,303.00	820
20X20	DFT2020P401	7,199.00	855
24X 4	DFT2404P401	POA	
24X 6	DFT2406P401	7,498.00	845
24X 8	DFT2408P401	8,866.00	860
24X10	DFT2410P401	9,042.00	880
24X12	DFT2412P401	7,787.00	890
24X14	DFT2414P401	9,160.00	900
24X16	DFT2416P401	7,950.00	915
24X18	DFT2418P401	12,048.00	1220
24X20	DFT2420P401	12,360.00	1510
24X24	DFT2424P401	11,016.00	1330
30X 6	DFT3006P401	15,362.00	1450
30X 8	DFT3008P401	15,408.00	
30X10	DFT3010P401	15,693.00	
30X12	DFT3012P401	15,693.00	1490
30X14	DFT3014P401	15,693.00	1490
30X16	DFT3016P401	15,834.00	1505
30X18	DFT3018P401	16,850.00	1515
30X20	DFT3020P401	16,163.00	1540
30X24	DFT3024P401	20,757.00	2025
30X30	DFT3030P401	18,428.00	2150
36X10	DFT3610P401	POA	3082
36X12	DFT3612P401	22,447.00	2170
36X14	DFT3614P401	22,494.00	2175
36X16	DFT3616P401	22,589.00	2185
36X18	DFT3618P401	22,637.00	2190
36X20	DFT3620P401	22,825.00	2210
36X24	DFT3624P401	23,253.00	2255

Contd.....

P 4 0 1 P 4 0 1 P 4 0 1 P 4 0 1 P 4 0 1 P 4 0 1 P 4 0 1 P 4 0 1 P 4 0 1 P 4 0 1 P 4 0 1 P 4 0 1

**FLANGE TEES**

Contd.....

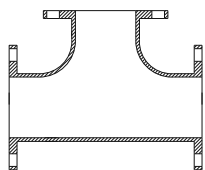

Size (in)	Item No.	List Price (\$)	Wt. (lb.)
36X30	DFT3630P401	30,304.00	3000
36X36	DFT3636P401	26,507.00	3160
42X12	DFT4212P401	34,181.00	3165
42X14	DFT4214P401	34,234.00	3170
42X16	DFT4216P401	34,331.00	3180
42X18	DFT4218P401	34,382.00	3185
42X20	DFT4220P401	34,584.00	3205
42X24	DFT4224P401	34,988.00	3245
42X30	DFT4230P401	43,877.00	4125
42X36	DFT4236P401	56,351.00	5360
42X42	DFT4242P401	58,575.00	5580
48X12	DFT4812P401	46,114.00	4315
48X14	DFT4814P401	46,114.00	4315
48X16	DFT4816P401	46,262.00	4330
48X18	DFT4818P401	46,262.00	4330
48X20	DFT4820P401	46,464.00	4350
48X24	DFT4824P401	46,821.00	4385
48X30	DFT4830P401	47,527.00	4455
48X36	DFT4836P401	58,638.00	7035
48X42	DFT4842P401	75,203.00	7195
48X48	DFT4848P401	77,121.00	7385
54X12	DFT5412P401	POA	4435
54X14	DFT5414P401	POA	4435
54X16	DFT5416P401	POA	4450
54X18	DFT5418P401	POA	4460
54X20	DFT5420P401	POA	4480
54X24	DFT5424P401	POA	4515
54X30	DFT5430P401	POA	4615
54X36	DFT5436P401	POA	4695
54X42	DFT5442P401	POA	5740
54X48	DFT5448P401	POA	5850
54X54	DFT5454P401	POA	6025

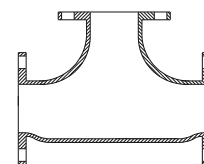
**FLANGE TEES - BULL HEAD**

Size (in)	Item No.	List Price (\$)	Wt. (lb.)
4 X 4 X 6	DFTBH040406P401	POA	90
6 X 6 X 8	DFTBH060608P401	POA	140
8 X 6 X 4	DFTBH080604P401	POA	146
8 X 8 X10	DFTBH080810P401	POA	260
8 X 8 X12	DFTBH080812P401	POA	291
10X10X12	DFTBH101012P401	POA	355

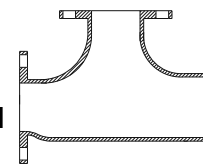
**FLANGE TEES - REDUCING ON THE RUN**

Size (in)	Item No.	List Price (\$)	Wt. (lb.)
4 X 3 X 3	DFTROR040303P401	POA	55
6 X 4 X 4	DFTROR060404P401	POA	103
6 X 4 X 6	DFTROR060406P401	POA	108
8 X 6 X 4	DFTROR080604P401	POA	146
8 X 6 X 6	DFTROR080606P401	POA	148
8 X 6 X 8	DFTROR080608P401	POA	145
10X 6 X 6	DFTROR100606P401	POA	275
10X 6 X10	DFTROR100610P401	POA	305
10X 8 X 6	DFTROR100806P401	POA	280
10X 8 X 8	DFTROR100808P401	POA	302
10X 8 X10	DFTROR100810P401	POA	325
12X 6 X 6	DFTROR120606P401	POA	340
12X 6 X 8	DFTROR120608P401	POA	360
12X 8 X 6	DFTROR120806P401	POA	355
12X 8 X 8	DFTROR120808P401	POA	375
12X 8 X12	DFTROR120812P401	POA	420
12X10X 6	DFTROR121006P401	POA	390
12X10X 8	DFTROR121008P401	POA	400
12X10X10	DFTROR121010P401	POA	420
12X10X12	DFTROR121012P401	POA	440

**FLANGE CROSS**

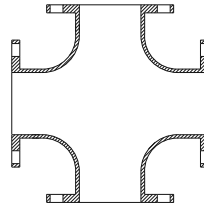

Size (in)	Item No.	List Price (\$)	Wt. (lb.)
3 X 3	DFX0303P401	776.00	50
4 X 3	DFX0403P401	811.00	70
4 X 4	DFX0404P401	776.00	80
6 X 3	DFX0603P401	1,128.00	95
6 X 4	DFX0604P401	1,220.00	110
6 X 6	DFX0606P401	1,236.00	120
8 X 3	DFX0803P401	1,688.00	140
8 X 4	DFX0804P401	1,697.00	155
8 X 6	DFX0806P401	1,781.00	175
8 X 8	DFX0808P401	1,793.00	195
10X 4	DFX1004P401	2,334.00	220
10X 6	DFX1006P401	2,499.00	240
10X 8	DFX1008P401	2,704.00	265
10X10	DFX1010P401	3,234.00	330
12X 4	DFX1204P401	3,179.00	310
12X 6	DFX1206P401	3,261.00	320
12X 8	DFX1208P401	3,467.00	345
12X10	DFX1210P401	4,041.00	415
12X12	DFX1212P401	3,705.00	460
14X 6	DFX1406P401	4,024.00	400
14X 8	DFX1408P401	4,230.00	425
14X10	DFX1410P401	4,515.00	460
14X12	DFX1412P401	4,887.00	505
14X14	DFX1414P401	5,090.00	530
16X 6	DFX1606P401	4,866.00	490
16X 8	DFX1608P401	5,111.00	520
16X10	DFX1610P401	5,398.00	555
16X12	DFX1612P401	5,810.00	605
16X14	DFX1614P401	8,234.00	620
16X16	DFX1616P401	6,303.00	755
18X 6	DFX1806P401	5,097.00	505
18X 8	DFX1808P401	5,342.00	535
18X10	DFX1810P401	5,547.00	560
18X12	DFX1812P401	5,958.00	610
18X14	DFX1814P401	6,860.00	720
18X16	DFX1816P401	7,231.00	765
18X18	DFX1818P401	7,474.00	795
20X 6	DFX2006P401	6,669.00	635
20X 8	DFX2008P401	6,935.00	665

Size (in)	Item No.	List Price (\$)	Wt. (lb.)
20X10	DFX2010P401	7,111.00	685
20X12	DFX2012P401	7,552.00	735
20X14	DFX2014P401	7,642.00	745
20X16	DFX2016P401	9,145.00	915
20X18	DFX2018P401	9,409.00	945
20X20	DFX2020P401	10,028.00	1015
24X 6	DFX2406P401	9,000.00	875
24X 8	DFX2408P401	9,178.00	895
24X10	DFX2410P401	9,486.00	930
24X12	DFX2412P401	9,751.00	960
24X14	DFX2414P401	9,884.00	975
24X16	DFX2416P401	10,193.00	1010
24X18	DFX2418P401	13,331.00	1365
24X20	DFX2420P401	13,904.00	1430
24X24	DFX2424P401	15,141.00	1570
30X10	DFX3010P401	POA	
30X12	DFX3012P401	16,403.00	1565
30X14	DFX3014P401	16,450.00	1570
30X16	DFX3016P401	16,780.00	1605
30X18	DFX3018P401	16,877.00	1515
30X20	DFX3020P401	17,396.00	1670
30X24	DFX3024P401	22,841.00	2245
30X30	DFX3030P401	25,254.00	2500
36X12	DFX3612P401	23,107.00	2240
36X14	DFX3614P401	23,107.00	2240
36X16	DFX3616P401	23,395.00	2270
36X18	DFX3618P401	23,488.00	2280
36X20	DFX3620P401	23,914.00	2325
36X24	DFX3624P401	24,671.00	2405
36X30	DFX3630P401	33,146.00	3300
36X36	DFX3636P401	36,177.00	3620
42X12	DFX4212P401	35,046.00	3240
42X14	DFX4214P401	35,046.00	3240
42X16	DFX4216P401	35,372.00	3270
42X18	DFX4218P401	34,595.00	3275
42X20	DFX4220P401	35,911.00	3320
42X24	DFX4224P401	36,723.00	4135
42X30	DFX4230P401	47,321.00	4375
42X36	DFX4236P401	61,869.00	5720

Contd.....

P 4 0 1 P 4 0 1 P 4 0 1 P 4 0 1 P 4 0 1 P 4 0 1 P 4 0 1

P 4 0 1 P 4 0 1 P 4 0 1 P 4 0 1 P 4 0 1 P 4 0 1 P 4 0 1 P 4 0 1

**FLANGE CROSS**

Contd.....

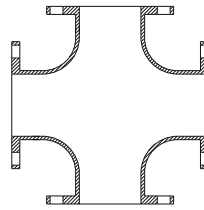

Size (in)	Item No.	List Price (\$)	Wt. (lb.)
42X42	DFX4242P401	66,576.00	6155
48X12	DFX4812P401	47,193.00	4390
48X14	DFX4814P401	47,138.00	4385
48X16	DFX4816P401	47,462.00	4415
48X18	DFX4818P401	47,516.00	4420
48X20	DFX4820P401	47,944.00	4460
48X24	DFX4824P401	48,751.00	4535
48X30	DFX4830P401	50,202.00	5705
48X36	DFX4836P401	63,210.00	7310
48X42	DFX4842P401	82,023.00	7630
48X48	DFX4848P401	89,191.00	8005

Size (in)	Item No.	List Price (\$)	Wt. (lb.)
54X12	DFX5412P401	POA	4575
54X14	DFX5414P401	POA	4575
54X16	DFX5416P401	POA	4605
54X18	DFX5418P401	POA	4625
54X20	DFX5420P401	POA	4665
54X24	DFX5424P401	POA	4700
54X30	DFX5430P401	POA	4800
54X36	DFX5436P401	POA	4950
54X42	DFX5442P401	POA	6210
54X48	DFX5448P401	POA	6425
54X54	DFX5454P401	POA	6780

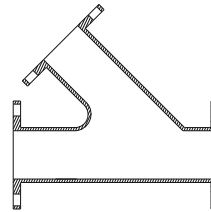
**FLANGE LATERAL WYES**

Size (in)	Item No.	List Price (\$)	Wt. (lb.)
3 X 3	DFY0303P401	707.00	45
4 X 2	DFY0402P401	POA	
4 X 3	DFY0403P401	769.00	65
4 X 4	DFY0404P401	707.00	75
6 X 3	DFY0603P401	POA	
6 X 4	DFY0604P401	1,262.00	105
6 X 6	DFY0606P401	1,114.00	120
8 X 4	DFY0804P401	1,902.00	165
8 X 6	DFY0806P401	1,842.00	175
8 X 8	DFY0808P401	1,733.00	200
10X 4	DFY1004P401	2,664.00	240
10X 6	DFY1006P401	2,745.00	250
10X 8	DFY1008P401	2,950.00	335
10X10	DFY1010P401	2,628.00	335
12X 4	DFY1204P401	3,753.00	350
12X 6	DFY1206P401	3,876.00	427
12X 8	DFY1208P401	3,835.00	452

Size (in)	Item No.	List Price (\$)	Wt. (lb.)
12X10	DFY1210P401	4,369.00	420
12X12	DFY1212P401	3,850.00	515
14X 6	DFY1406P401	5,008.00	475
14X 8	DFY1408P401	5,214.00	500
14X10	DFY1410P401	5,049.00	525
14X12	DFY1412P401	5,828.00	570
14X14	DFY1414P401	5,707.00	605
16X 6	DFY1606P401	5,933.00	620
16X 8	DFY1608P401	6,671.00	645
16X10	DFY1610P401	6,916.00	675
16X12	DFY1612P401	6,712.00	715
16X14	DFY1614P401	7,656.00	755
16X16	DFY1616P401	7,452.00	805
18X 6	DFY1806P401	POA	
18X 8	DFY1808P401	6,082.00	780
18X10	DFY1810P401	8,216.00	810
18X12	DFY1812P401	8,585.00	850

Contd.....

**FLANGE LATERAL WYES**

Contd.....

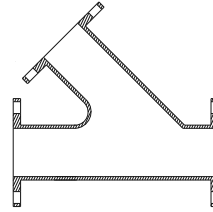

Size (in)	Item No.	List Price (\$)	Wt. (lb.)
18X14	DFY1814P401	8,952.00	885
18X16	DFY1816P401	9,363.00	935
18X18	DFY1818P401	8,992.00	1035
20X 8	DFY2008P401	POA	740
20X10	DFY2010P401	8,172.00	1025
20X12	DFY2012P401	10,867.00	1065
20X14	DFY2014P401	11,794.00	1110
20X16	DFY2016P401	12,281.00	1155
20X18	DFY2018P401	12,318.00	1200
20X20	DFY2020P401	12,237.00	1265
24X 6	DFY2406P401	POA	
24X 8	DFY2408P401	POA	1425
24X10	DFY2410P401	POA	1460
24X12	DFY2412P401	11,872.00	1550
24X14	DFY2414P401	12,873.00	1560
24X16	DFY2416P401	17,969.00	1615
24X18	DFY2418P401	17,076.00	1680
24X20	DFY2420P401	17,538.00	1750
24X24	DFY2424P401	18,103.00	1905
30X12	DFY3012P401	30,620.00	2545
30X14	DFY3014P401	30,620.00	2590
30X16	DFY3016P401	30,997.00	2645
30X18	DFY3018P401	31,183.00	2690
30X20	DFY3020P401	31,658.00	2760
30X24	DFY3024P401	31,931.00	2915
30X30	DFY3030P401	32,122.00	3225
36X12	DFY3612P401	46,716.00	4490
36X14	DFY3614P401	46,815.00	4545
36X16	DFY3616P401	47,057.00	4000
36X18	DFY3618P401	47,120.00	4670

Size (in)	Item No.	List Price (\$)	Wt. (lb.)
36X20	DFY3620P401	47,520.00	4750
36X24	DFY3624P401	48,012.00	4920
36X30	DFY3630P401	54,705.00	5255
36X36	DFY3636P401	56,251.00	5740
42X12	DFY4212P401	59,123.00	5725
42X14	DFY4214P401	59,215.00	5800
42X16	DFY4216P401	59,383.00	5850
42X18	DFY4218P401	59,471.00	6000
42X20	DFY4220P401	59,811.00	6680
42X24	DFY4224P401	59,837.00	6850
42X30	DFY4230P401	75,586.00	7185
42X36	DFY4236P401	79,694.00	7670
42X42	DFY4242P401	1,01,555.00	9185
48X12	DFY4812P401	78,422.00	7200
48X14	DFY4814P401	78,422.00	7276
48X16	DFY4816P401	78,676.00	7400
48X18	DFY4818P401	78,676.00	7620
48X20	DFY4820P401	79,009.00	7685
48X24	DFY4824P401	79,601.00	8695
48X30	DFY4830P401	80,784.00	5573
48X36	DFY4836P401	99,667.00	9515
48X42	DFY4842P401	1,02,116.00	11030
48X48	DFY4848P401	1,33,648.00	12115
54X24	DFY5424P401	POA	6220
54X30	DFY5430P401	POA	7478
54X36	DFY5436P401	POA	7600
54X42	DFY5442P401	POA	8930
54X48	DFY5448P401	POA	9480
54X54	DFY5454P401	POA	11780
60X30	DFY6030P401	POA	9045

P401 P401 P401 P401 P401 P401 P401 P401 P401 P401

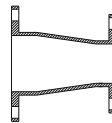

P 4 0 1 P 4 0 1 P 4 0 1 P 4 0 1 P 4 0 1 P 4 0 1 P 4 0 1 P 4 0 1 P 4 0 1 P 4 0 1 P 4 0 1 P 4 0 1

**CONCENTRIC REDUCER**

Size (in)	Item No.	List Price (\$)	Wt. (lb.)
3 X 2	DFCR0302P401	POA	16
4 X 2	DFCR0402P401	POA	25
4 X 2.5	DFCR0402.5P401	POA	26
4 X 3	DFCR0403P401	409.00	30
6 X 2	DFCR0602P401	POA	35
6 X 3	DFCR0603P401	642.00	40
6 X 4	DFCR0604P401	632.00	45
6 X 5	DFCR0605P401	739.00	52
8 X 3	DFCR0803P401	876.00	60
8 X 4	DFCR0804P401	893.00	65
8 X 5	DFCR0805P401	1,003.00	70
8 X 6	DFCR0806P401	938.00	75
10X 4	DFCR1004P401	1,228.00	85
10X 6	DFCR1006P401	1,197.00	90
10X 8	DFCR1008P401	1,363.00	110
12X 4	DFCR1204P401	1,619.00	120
12X 6	DFCR1206P401	1,624.00	130
12X 8	DFCR1208P401	1,743.00	145
12X10	DFCR1210P401	1,887.00	170
14X 6	DFCR1406P401	2,015.00	155
14X 8	DFCR1408P401	2,180.00	175
14X10	DFCR1410P401	2,319.00	190
14X12	DFCR1412P401	2,225.00	248
16X 6	DFCR1606P401	2,405.00	190
16X 8	DFCR1608P401	2,261.00	210
16X10	DFCR1610P401	2,437.00	235
16X12	DFCR1612P401	2,758.00	265
16X14	DFCR1614P401	3,141.00	280
18X 8	DFCR1808P401	2,921.00	240
18X10	DFCR1810P401	3,127.00	265
18X12	DFCR1812P401	3,075.00	295
18X14	DFCR1814P401	3,495.00	310
18X16	DFCR1816P401	3,408.00	340
20X 6	DFCR2006P401	POA	

Size (in)	Item No.	List Price (\$)	Wt. (lb.)
20X 8	DFCR2008P401	POA	
20X10	DFCR2010P401	3,795.00	310
20X12	DFCR2012P401	3,674.00	345
20X14	DFCR2014P401	4,195.00	355
20X16	DFCR2016P401	3,866.00	390
20X18	DFCR2018P401	4,682.00	410
24X 8	DFCR2408P401	POA	410
24X10	DFCR2410P401	POA	
24X12	DFCR2412P401	5,778.00	480
24X14	DFCR2414P401	5,896.00	490
24X16	DFCR2416P401	5,163.00	525
24X18	DFCR2418P401	6,127.00	550
24X20	DFCR2420P401	6,481.00	590
30X12	DFCR3012P401	POA	825
30X16	DFCR3016P401	8,968.00	770
30X18	DFCR3018P401	9,254.00	810
30X20	DFCR3020P401	POA	870
30X24	DFCR3024P401	POA	970
36X16	DFCR3616P401	POA	1105
36X18	DFCR3618P401	POA	
36X20	DFCR3620P401	POA	1230
36X24	DFCR3624P401	POA	1345
36X30	DFCR3630P401	POA	1555
42X24	DFCR4224P401	POA	1820
42X30	DFCR4230P401	POA	2060
42X36	DFCR4236P401	POA	2550
48X30	DFCR4830P401	POA	2625
48X36	DFCR4836P401	POA	2950
48X42	DFCR4842P401	POA	3320
54X30	DFCR5430P401	POA	1625
54X36	DFCR5436P401	POA	1680
54X42	DFCR5442P401	POA	1800
54X48	DFCR5448P401	POA	1695

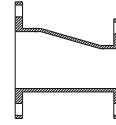
**ECCENTRIC REDUCER**

Size (in)	Item No.	List Price (\$)	Wt. (lb.)
3 X 2	DFER0302P401	POA	16
4 X 2	DFER0402P401	POA	25
4 X 3	DFER0403P401	459.00	30
6 X 2	DFER0602P401	POA	35
6 X 3	DFER0603P401	642.00	40
6 X 4	DFER0604P401	690.00	45
6 X 5	DFER0605P401	748.00	52
8 X 3	DFER0803P401	959.00	60
8 X 4	DFER0804P401	POA	65
8 X 5	DFER0805P401	1,003.00	70
8 X 6	DFER0806P401	1,040.00	75
10X 4	DFER1004P401	1,228.00	85
10X 6	DFER1006P401	1,268.00	90
10X 8	DFER1008P401	1,432.00	110
12X 4	DFER1204P401	1,619.00	120
12X 6	DFER1206P401	1,702.00	130
12X 8	DFER1208P401	1,824.00	145
12X10	DFER1210P401	2,030.00	170
14X 6	DFER1406P401	2,015.00	155
14X 8	DFER1408P401	2,138.00	175
14X10	DFER1410P401	2,299.00	190
14X12	DFER1412P401	2,588.00	248
16X 6	DFER1606P401	2,405.00	190
16X 8	DFER1608P401	2,567.00	210
16X10	DFER1610P401	2,775.00	235
16X12	DFER1612P401	3,019.00	265
16X14	DFER1614P401	3,141.00	280
18X 8	DFER1808P401	2,921.00	240
18X10	DFER1810P401	3,127.00	265
18X12	DFER1812P401	3,371.00	295
18X14	DFER1814P401	3,495.00	310
18X16	DFER1816P401	3,740.00	340
20X 8	DFER2008P401	POA	
20X10	DFER2010P401	3,795.00	310

Size (in)	Item No.	List Price (\$)	Wt. (lb.)
20X12	DFER2012P401	4,106.00	345
20X14	DFER2014P401	4,195.00	355
20X16	DFER2016P401	4,503.00	390
20X18	DFER2018P401	4,679.00	410
24X 8	DFER2408P401	POA	
24X10	DFER2410P401	POA	
24X12	DFER2412P401	5,509.00	480
24X14	DFER2414P401	5,597.00	490
24X16	DFER2416P401	5,906.00	525
24X18	DFER2418P401	6,127.00	550
24X20	DFER2420P401	6,481.00	590
30X10	DFER3010P401	POA	
30X14	DFER3014P401	11,304.00	825
30X16	DFER3016P401	10,437.00	770
30X18	DFER3018P401	9,300.00	810
30X20	DFER3020P401	9,821.00	870
30X24	DFER3024P401	10,767.00	970
36X14	DFER3614P401	POA	1290
36X16	DFER3616P401	POA	1105
36X18	DFER3618P401	POA	
36X20	DFER3620P401	POA	1230
36X24	DFER3624P401	14,584.00	1345
36X30	DFER3630P401	POA	1555
42X24	DFER4224P401	20,595.00	1820
42X30	DFER4230P401	23,020.00	2060
42X36	DFER4236P401	25,898.00	2550
48X24	DFER4824P401	POA	
48X30	DFER4830P401	29,042.00	2625
48X36	DFER4836P401	32,325.00	2950
48X42	DFER4842P401	36,063.00	3320
54X30	DFER5430P401	POA	1625
54X36	DFER5436P401	POA	1680
54X42	DFER5442P401	POA	1800
54X48	DFER5448P401	POA	1695

P401 P401 P401 P401 P401 P401 P401

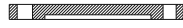
**BLIND FLANGES**

Size (in)	Item No.	List Price (\$)	Wt. (lb.)
2	DBF02P401	POA	9
3	DBF03P401	281.00	9
4	DBF04P401	344.00	16
6	DBF06P401	526.00	25
8	DBF08P401	718.00	42
10	DBF10P401	1,081.00	63
12	DBF12P401	1,454.00	85
14	DBF14P401	2,048.00	120
16	DBF16P401	2,486.00	145
18	DBF18P401	3,335.00	195
20	DBF20P401	4,505.00	245
24	DBF24P401	6,703.00	370
30	DBF30P401	9,852.00	500
36	DBF36P401	18,904.00	960
42	DBF42P401	27,308.00	1300
48	DBF48P401	36,545.00	1740
54	DBF54P401	POA	2600

**2" TAPPED  
BLIND FLANGES**

Size (in)	Item No.	List Price (\$)	Wt. (lb.)
3	DBFT03P401	413.00	9
4	DBFT04P401	413.00	16
6	DBFT06P401	559.00	25
8	DBFT08P401	850.00	42
10	DBFT10P401	1,215.00	63
12	DBFT12P401	1,588.00	85
14	DBFT14P401	2,258.00	120
16	DBFT16P401	2,695.00	145
18	DBFT18P401	3,595.00	195
20	DBFT20P401	4,769.00	245
24	DBFT24P401	6,968.00	370
30	DBFT30P401	10,248.00	500
36	DBFT36P401	19,301.00	960
42	DBFT42P401	27,835.00	1300
48	DBFT48P401	37,073.00	1740
54	DBFT54P401	POA	2600

P 4 0 1 P 4 0 1 P 4 0 1 P 4 0 1 P 4 0 1 P 4 0 1 P 4 0 1 P 4 0 1 P 4 0 1 P 4 0 1

**NOTES**



# SIP Industries

Quality Manufacturers Since 1960

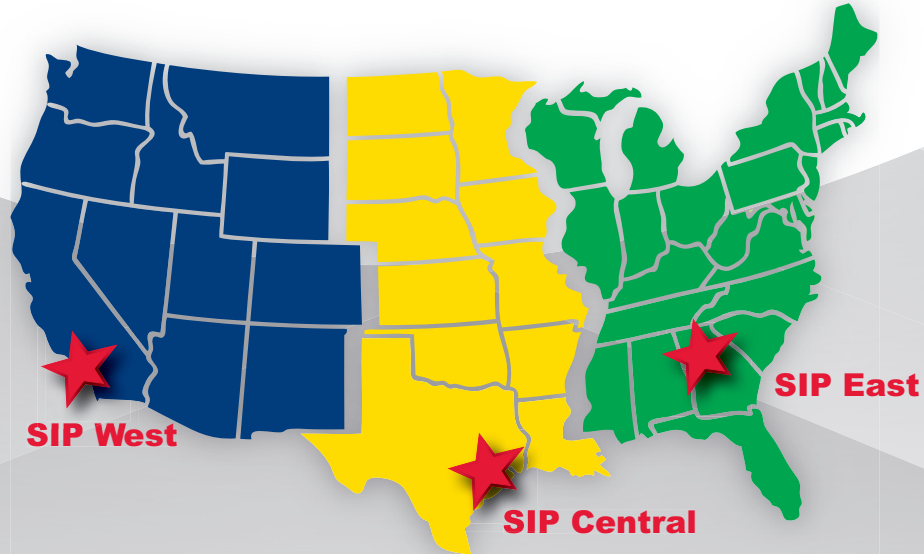

## PRODUCT LINE

### AWWA DI Fittings & Accessories

- C153 Compact MJ Fittings and Acc. 2" - 64"
- C110 Full Body MJ Fittings 2" - 64"
- C153 Trim Tyton® Push-On Fittings 4" - 24"
- C110 Flange Fittings 2" - 64"
- MJ x MJ Adapter for Connecting MJ Bells 3" - 24"
- Stainless Steel & Blue T-Bolts
- Made in India, China & Mexico
- Bare, Cement, Zinc, FBE & Other Linings

### Joint Restraint System

- EZD Joint Restraint for DI Pipe 3" - 48"
- EZDTP Joint Restraint Tandem for DI Pipe 3" - 48"
- EZDPTP Joint Restraint for Push-On Joints DI Pipe 3" - 48"
- Ductile Iron Retainer Glands 3" - 30"
- FAR / FAH Flange Adapter for DI Pipe 3" - 48"
- EZFA Restrained Flange Adapter for DI and PVC Pipe 3" - 36"
- EZPVC Joint Restraint for PVC Pipe 3" - 36"
- ULTRA Joint Restraint for PVC Pipe 4" - 12"
- EZPVCPTP Joint Restraint for Push-On Joints PVC Pipe 14" - 36"
- PTPVC Pipe to Pipe Restraint 4" - 48"
- PTPDF Pipe to MJ Fittings Restraint 4" - 48"
- PTPFC Pipe to PVC Fittings Restraint 4" - 12"
- Made in China & USA
- EZ Shield or Shop Coating

### Municipal Construction Castings

- Manhole Rings and Cover
- Frames and Grates
- Valve Boxes and Service Boxes
- Water Meter Covers and Boxes
- Cleanout and Monument Boxes
- Detectable Warning Plates
- Extension Rings
- Trench Grates and Tree Grates
- Made in India & USA

### Fabrication Products for DI Pipe

- High Hub Flanges Class 150 and 250. 3" - 64"
- Threaded Bell Flanges 3" - 48"
- Anchor Flanges 3" - 60"
- Filler Flanges 4" - 30"

### Other Products and Services

- All Thread Rod
- Pipe Lube and Hydraulic Cement
- Socket Clamps and Lugs
- Flange Packs
- OEM Castings



**SIP CORPORATE** 8876 Gulf Freeway, Suite 500, Houston, TX 77017

**SIP CENTRAL** 2900 Patio Drive, Houston, TX 77017

**SIP EAST** 600 Rayloc Drive, Atlanta, GA 30336

**SIP WEST** 8333 Almeria Avenue, Fontana, CA 92335

Phone: 877-921-6111 or 713-923-6111 | Fax: 713-923-6114 | [www.sipindustries.com](http://www.sipindustries.com) | [sales@sipindustries.com](mailto:sales@sipindustries.com)