

**60**  
60 YEARS OF SERVICE

\*\*\*  
**SIP INDUSTRIES**  
SERAMPORE  
SINCE 1960

# SIP Industries



Quality Manufacturers Since 1960

## Utility Pipe Fittings Zinc Coated

# PRICE LIST

Effective : January 14, 2019

[www.sipindustries.com](http://www.sipindustries.com)

Toll Free 877-921-6111





## TABLE OF CONTENTS

GENERAL TERMS & CONDITIONS.....	Page : P002 - P004
ZINC COATED-COMPACT MJ FITTINGS ANSI/AWWA C153/A21.53.....	Page : P005 - P018
ZINC COATED-FULL BODY MJ FITTINGS ANSI/AWWA C110/A21.10.....	Page : P019 - P032
ZINC COATED-COMPACT PUSH-ON FITTINGS ANSI/AWWA C153/A21.53.....	Page : P033 - P040
ZINC COATED-FLANGE FITTINGS ANSI/AWWA C110/A21.10.....	Page : P041 - P054

- All dimensions are in inches unless noted otherwise.
- All weights are approximate in pounds unless noted otherwise.
- POA = Price on availability.
- R = Available multiple size reductions.

## SIP INDUSTRIES

### GENERAL TERMS AND CONDITIONS OF SALE

**1. Acceptance.** All sales by SIP Industries (Seller) are made pursuant to these Terms and Conditions. Submission of a purchase order to Seller, and/or acceptance of goods delivered by Seller, shall be deemed an acceptance of these Terms and Conditions by Purchaser. Please note that these Terms and Conditions may be modified from time to time; the applicable Terms and Conditions are those posted on SIP's website, [www.sipindustries.com](http://www.sipindustries.com), at the time that a purchase order is accepted or an agreement otherwise confirmed. Purchaser's alteration or addition to these Terms and Conditions, as same may be in effect from time to time, is expressly rejected unless accepted in writing by an authorized representative of Seller.

**2. Entire Agreement.** These Terms and Conditions, together with Seller's price list and Purchaser's purchase order, when accepted by Seller, shall be the entire agreement between Seller and Purchaser. Neither Seller nor Purchaser is relying on any representations, warranties or agreements except as expressly provided in these Terms and Conditions and in an accepted purchase order. To the extent of any conflict between the terms of a purchase order or any other documents submitted by Purchaser, on the one hand, and these Terms and Conditions, on the other, these Terms and Conditions shall govern.

**3. Prices.** Prices and descriptions of goods stated in Seller's price lists are subject to change without notice. Prices are subject to tariffs, raw material surcharges, labor disputes and shipping surcharges. To submit a purchase order, SIP Industries item numbers and part codes should be included. Seller's quotations are on globally sourced products unless otherwise noted. The ordering party is responsible to specify any required origin as required for end use. Quotations, if provided by Seller, expire sixty (60) days from the date provided unless otherwise agreed in writing.

**4. Terms.** Invoices are due and payable thirty (30) days from date of shipment, unless otherwise written on the invoice or confirmed in writing by Seller. A five percent (5%) late fee will be charged on all past-due accounts. If it becomes necessary to retain attorneys to collect an account, the Purchaser is liable for Seller's attorney's fees and other costs of collection.

**5. FOB point of shipment.** All prices are FOB point of shipment, unless otherwise agreed in writing. Seller's responsibility for goods therefore ceases and title passes to the Purchaser at the point of shipment; all claims for damages or losses in transit must be directed to the carrier with copy to Seller within ten (10) days of shipment.

**6. Delivery.** Seller shall have the right to select the freight carrier unless otherwise agreed. Seller has the right to substitute material with same function and design to accommodate unforeseen delays, shortages or restrictions.

**7. Cancellations, Changes and Returns.** All cancellations, changes and returns must be accepted in writing by an authorized representative of Seller, otherwise they will not be valid and binding on Seller. Seller will not be responsible for unauthorized returned product. It will be the responsibility of purchaser at their expense to have unauthorized product returned or disposed of. Seller shall not be obligated to accept any cancellation, change or return, but if it does so the following terms shall apply: (i) goods must be returned to Seller's facility, in the same condition in which they were accepted by Purchaser; (ii) a handling charge of thirty-five percent (35%) of the purchase price will be deducted from the credit given to Purchaser; and (iii) shipping charges, if not prepaid by Purchaser, will likewise be deducted from the credit given to Purchaser.

**8. Specially Manufactured Goods.** Unless otherwise agreed, specially-manufactured goods, including goods designed to the Purchaser's specifications, may not be cancelled or returned once work has begun to design or manufacture the goods unless an agreement is reached and confirmed in writing by Seller, including compensation to Seller for work thus far done with respect to the goods.

**9. Delays; Force Majeure.** Seller shall not be liable for any expenses, loss or damage resulting from any delay in delivery of goods or other failure of Seller's performance due to fire, floods, acts of god, strikes, labor disputes, labor shortages, riots, accidents, transportation delays or other causes beyond the reasonable control of Seller.

**10. Disclaimer regarding weights.** All stated weights are approximate and are given for inventory and shipping purposes only.

**11. Taxes.** Seller's prices do not include sales, excise or other taxes. Purchaser shall pay all such taxes. If Purchaser claims a tax exemption, Purchaser shall provide Seller with the necessary tax-exemption numbers and certificates. If Seller accepts an exemption but is later required by the taxing authority to pay taxes, Purchaser shall reimburse to Seller the amount of such taxes.

**12. Limited Warranty.** For a period of one calendar year from the date of shipment, Seller warrants that goods sold and delivered by Seller to Purchaser will conform to the number and type of goods described in the accepted purchase order and that such goods will be free from defects in material and workmanship.

THIS LIMITED WARRANTY IS SELLER'S SOLE AND EXCLUSIVE WARRANTY. SELLER MAKES NO OTHER WARRANTY OF ANY KIND, EXPRESS OR IMPLIED. SELLER DOES NOT WARRANT THAT THE GOODS ARE FIT FOR ANY PARTICULAR PURPOSE. SELLER DOES NOT WARRANT THAT THE GOODS ARE MERCHANTABILITY.

**13. Product Disclaimers.** All tooling required to manufacture products are the property of Seller even if tooling costs are incurred by Purchaser. Seller has the right to change product design, engineering, materials, tooling and processes that do not affect the intended use and application of the product. Seller will notify Purchaser if changes are substantial and may affect the application or appearance of the product. Furthermore, references to Buyer's specifications and similar requirements are only to describe the goods and do not give rise to any representation, warranty or other sales term.

Seller manufactures to industry standards and makes every effort to address applications of its products. Please see current technical advisory at Seller's web site, sipindustries.com, for up to date product support and recommendations. All product dimension, designs, technology, tooling, process, software, innovations, and drawings are considered intellectual property and are owned and confidential to Seller. Purchaser has no rights or privileges to SIP industries intellectual property including product applications without Seller's express written consent.

**14. Prompt notice required for Limited Warranty claims.** Buyer is responsible for promptly inspecting goods on delivery and notifying Seller, within sixty (60) days of delivery to Buyer, of any nonconformity or defect that would be discovered on a reasonable and customary inspection. Provided that such notice is given and that the warranty claim is made within one year, Seller will provide a replacement or price adjustment, in Seller's discretion, not to exceed the net sales price of the defective product. However, this warranty shall be of no force or effect absent such timely notice. Seller shall not in any event be responsible for labor, removal or installation charges incurred in connection with the replacement of defective goods.

**15. Conditions to Limited Warranty.** Purchaser shall notify Seller immediately upon discovery of a defect so that Seller may inspect the product in its installed condition. Seller shall not be responsible for defects or failures in goods of which it is not so notified; nor shall Seller be responsible for goods manufactured or sold by other parties or losses or impairments caused by such goods; nor shall Seller be responsible for defects or failure of goods due to improper installation, improper usage, normal or abnormal wear and tear, erosion or corrosion, improper storage, use or maintenance, vandalism, vehicular or other accidents, or storms or other forces beyond the control of the parties. Seller also shall not be responsible for goods that have been damaged by misuse, negligence or accident or that have been altered or repaired by any party other than Seller.

**16. Limitation on Liability.** In the event any remedy hereunder fails of its essential purpose and monetary damages may be imposed, Seller's liability, whether founded in contract or tort (including negligence), arising out of or resulting from (i) the Purchase Order and resulting contract or the performance or breach thereof, or (ii) the design, manufacture, delivery, sale, repair, replacement or use of the goods, shall not exceed the cost of the goods at issue in the claim. NOTWITHSTANDING ANYTHING CONTAINED HEREIN TO THE CONTRARY, SELLER SHALL NOT BE LIABLE TO PURCHASER OR ANY OTHER PERSON FOR CONSEQUENTIAL, INCIDENTAL, SPECIAL, EXEMPLARY, PUNITIVE OR OTHER INDIRECT DAMAGES, INCLUDING, WITHOUT LIMITATION, LOSS OF PROFITS, RECALL-RELATED EXPENSES, AND LOSS OF USE OF THE GOODS.

**17. Purchaser specifications.** If Seller has designed the goods using information provided by Purchaser, Seller shall not be responsible for design errors resulting from inaccurate or incomplete information supplied by Purchaser. If

Purchaser has provided specifications or a model or sample from which a good is designed and manufactured, Seller shall not be responsible for any defect, error or inadequacy provided that the good is designed or manufactured in compliance with Purchaser's specifications, model or sample.

**18. Solvency and Security Interest.** By submitting a Purchase Order, Buyer represents to Seller that Buyer is solvent and capable of timely fulfilling its payment and other obligations to Seller. Until the goods and any other indebtedness of Buyer have been paid in full, Buyer, its agents any successors: (i) will hold the goods subject to a security interest in favor of Seller allowing for the right or re-possession by Seller to the extent permitted by applicable law, (ii) will not alter, remove, destroy, or damage any identifying mark on the goods or their packaging, and (iii) will keep the goods separate from any other products.

**19. Governing law; venue.** All sales shall be governed by the law of the state of Texas. In the event that a lawsuit is filed between the parties on any claim arising out of or in connection with such sales, Seller and Purchaser agree that exclusive venue and jurisdiction shall be in the state or federal courts of Harris County, Texas.

**20. Attorney's fees and costs.** In the event of litigation between the parties with respect to the sale of goods, the prevailing party shall be entitled to recover its reasonable attorney's fees and costs, including expert witness fees.

# Utility Pipe Fittings Zinc Coated

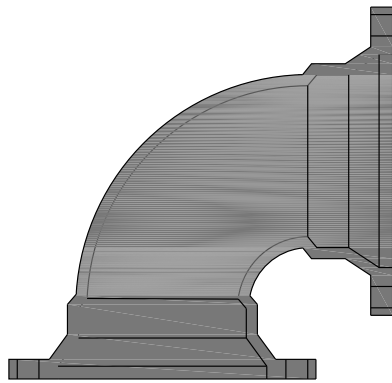

ANSI/AWWA C153/A21.53  
**COMPACT MJ FITTINGS**  
**ZINC COATED**

## PRICE LIST

Effective January 14, 2019.

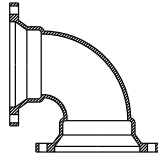
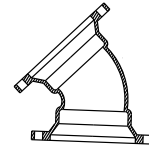

**BENDS : MJ X MJ**  
**90° (1/4)**

**BENDS : MJ X MJ**  
**45° (1/8)**

Size (in)	Item No.	Crt. Qty.	List Price (\$)	Wt. (lb.)
2	CDMJB9002Z	36	POA	14
3	CDMJB9003Z	80	117.00	23
4	CDMJB9004Z	60	127.00	27
6	CDMJB9006Z	36	206.00	39
8	CDMJB9008Z	18	303.00	57
10	CDMJB9010Z	12	475.00	89
12	CDMJB9012Z	8	637.00	108
14	CDMJB9014Z	4	1,065.00	210
16	CDMJB9016Z	2	1,424.00	264
18	CDMJB9018Z		1,722.00	335
20	CDMJB9020Z		2,336.00	400
24	CDMJB9024Z		3,492.00	565
30	CDMJB9030Z		5,613.00	960
36	CDMJB9036Z		8,768.00	1499
42	CDMJB9042Z		14,916.00	2205
48	CDMJB9048Z		19,888.00	2990

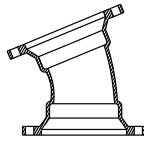
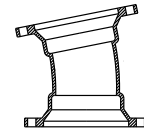
Size (in)	Item No.	Crt. Qty.	List Price (\$)	Wt. (lb.)
2	CDMJB4502Z	36	POA	13
3	CDMJB4503Z	80	104.00	21
4	CDMJB4504Z	100	104.00	23
6	CDMJB4506Z	48	169.00	32
8	CDMJB4508Z	27	245.00	46
10	CDMJB4510Z	18	355.00	70
12	CDMJB4512Z	12	527.00	86
14	CDMJB4514Z	8	828.00	164
16	CDMJB4516Z	8	1,033.00	202
18	CDMJB4518Z	2	1,427.00	250
20	CDMJB4520Z		1,553.00	305
24	CDMJB4524Z		2,316.00	405
30	CDMJB4530Z		4,713.00	783
36	CDMJB4536Z		6,884.00	1142
42	CDMJB4542Z		10,498.00	1610
48	CDMJB4548Z		13,757.00	2090

**BENDS : MJ X MJ**  
**22½° (1/16)**

**BENDS : MJ X MJ**  
**11¼° (1/32)**

Size (in)	Item No.	Crt. Qty.	List Price (\$)	Wt. (lb.)
2	CDMJB2202Z	50	POA	9
3	CDMJB2203Z	50	66.00	16
4	CDMJB2204Z	100	100.00	18
6	CDMJB2206Z	48	154.00	32
8	CDMJB2208Z	27	240.00	46
10	CDMJB2210Z	18	352.00	64
12	CDMJB2212Z	12	462.00	84
14	CDMJB2214Z	8	839.00	148
16	CDMJB2216Z	8	980.00	178
18	CDMJB2218Z	2	1,216.00	255
20	CDMJB2220Z	2	1,627.00	310
24	CDMJB2224Z	2	2,155.00	412
30	CDMJB2230Z		3,962.00	796
36	CDMJB2236Z		5,790.00	1160
42	CDMJB2242Z		8,648.00	1350
48	CDMJB2248Z		11,285.00	1760

Size (in)	Item No.	Crt. Qty.	List Price (\$)	Wt. (lb.)
2	CDMJB1102Z	30	POA	8
3	CDMJB1103Z	30	75.00	14
4	CDMJB1104Z	50	94.00	16
6	CDMJB1106Z	60	160.00	30
8	CDMJB1108Z	27	217.00	42
10	CDMJB1110Z	18	339.00	58
12	CDMJB1112Z	16	428.00	74
14	CDMJB1114Z	8	936.00	130
16	CDMJB1116Z	4	1,015.00	158
18	CDMJB1118Z	2	1,494.00	205
20	CDMJB1120Z	2	1,513.00	245
24	CDMJB1124Z	2	2,012.00	315
30	CDMJB1130Z		3,947.00	800
36	CDMJB1136Z		5,395.00	1165
42	CDMJB1142Z		8,095.00	1180
48	CDMJB1148Z		10,967.00	1475

\* AWWA C110

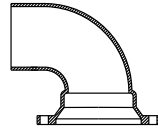

BENDS : MJ X PE  
90° (1/4)

Size (in)	Item No.	Crt. Qty.	List Price (\$)	Wt. (lb.)
3	CDMJPB9003Z	72	112.00	16
4	CDMJPB9004Z	60	145.00	22
6	CDMJPB9006Z	36	247.00	41
8	CDMJPB9008Z	9	340.00	61
10	CDMJPB9010Z	12	536.00	83
12	CDMJPB9012Z	8	698.00	114
14	CDMJPB9014Z	4	1,207.00	197
16	CDMJPB9016Z	4	1,848.00	248
18	CDMJPB9018Z		POA	325
20	CDMJPB9020Z		3,363.00	390
24	CDMJPB9024Z		3,784.00	575
30	CDMJPB9030Z		POA	945
36	CDMJPB9036Z		POA	1362
42	CDMJPB9042Z		POA	2068
48	CDMJPB9048Z		POA	

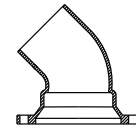
BENDS : MJ X PE  
45° (1/8)

Size (in)	Item No.	Crt. Qty.	List Price (\$)	Wt. (lb.)
3	CDMJPB4503Z	100	94.00	13
4	CDMJPB4504Z	100	109.00	19
6	CDMJPB4506Z	24	185.00	34
8	CDMJPB4508Z	24	289.00	49
10	CDMJPB4510Z	18	434.00	72
12	CDMJPB4512Z	12	604.00	98
14	CDMJPB4514Z	8	964.00	148
16	CDMJPB4516Z	8	1,158.00	184
18	CDMJPB4518Z	2	POA	235
20	CDMJPB4520Z		2,534.00	290
24	CDMJPB4524Z		2,566.00	390
30	CDMJPB4530Z		POA	772
36	CDMJPB4536Z		POA	1056
42	CDMJPB4542Z		POA	1505
48	CDMJPB4548Z		POA	2055

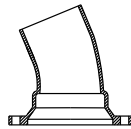
BENDS : MJ X PE  
22½° (1/16)

Size (in)	Item No.	Crt. Qty.	List Price (\$)	Wt. (lb.)
3	CDMJPB2203Z	100	80.00	12
4	CDMJPB2204Z	100	110.00	18
6	CDMJPB2206Z	48	186.00	29
8	CDMJPB2208Z		288.00	43
10	CDMJPB2210Z	18	387.00	61
12	CDMJPB2212Z	12	505.00	81
14	CDMJPB2214Z	8	999.00	133
16	CDMJPB2216Z	8	1,560.00	166
18	CDMJPB2218Z		POA	235
20	CDMJPB2220Z		POA	300
24	CDMJPB2224Z		3,369.00	395
30	CDMJPB2230Z		POA	600
36	CDMJPB2236Z		POA	
42	CDMJPB2242Z		POA	
48	CDMJPB2248Z		POA	

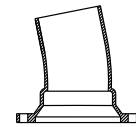
BENDS : MJ X PE  
11¼° (1/32)

Size (in)	Item No.	Crt. Qty.	List Price (\$)	Wt. (lb.)
3	CDMJPB1103Z	100	80.00	12
4	CDMJPB1104Z	100	106.00	17
6	CDMJPB1106Z	48	175.00	27
8	CDMJPB1108Z		272.00	39
10	CDMJPB1110Z	18	342.00	52
12	CDMJPB1112Z	12	438.00	70
14	CDMJPB1114Z	8	816.00	122
16	CDMJPB1116Z	8	1,012.00	148
18	CDMJPB1118Z		POA	235
20	CDMJPB1120Z		POA	300
24	CDMJPB1124Z		3,375.00	465
30	CDMJPB1130Z		POA	562
42	CDMJPB1142Z		POA	

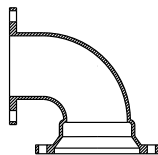
**BENDS : MJ X FE**  
**90° (1/4)**

Size (in)	Item No.	Crt. Qty.	List Price (\$)	Wt. (lb.)
3	CDMJFB9003Z	72	123.00	20
4	CDMJFB9004Z	48	154.00	26
6	CDMJFB9006Z	27	265.00	47
8	CDMJFB9008Z	18	442.00	68
10	CDMJFB9010Z	12	690.00	102
12	CDMJFB9012Z	8	983.00	134
14	CDMJFB9014Z	4	1,683.00	223
16	CDMJFB9016Z	4	2,048.00	303
24	CDMJFB9024Z		POA	625
30	CDMJFB9030Z		POA	1020

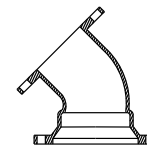
**BENDS : MJ X FE**  
**45° (1/8)**

Size (in)	Item No.	Crt. Qty.	List Price (\$)	Wt. (lb.)
3	CDMJFB4503Z	32	POA	17
4	CDMJFB4504Z	100	152.00	24
6	CDMJFB4506Z	48	223.00	39
8	CDMJFB4508Z	27	425.00	57
10	CDMJFB4510Z	18	645.00	83
12	CDMJFB4512Z	12	927.00	111
14	CDMJFB4514Z	8	1,365.00	208
16	CDMJFB4516Z	8	1,904.00	300
24	CDMJFB4524Z		POA	617
30	CDMJFB4530Z		POA	1014

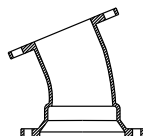
**BENDS : MJ X FE**  
**22½° (1/16)**

Size (in)	Item No.	Crt. Qty.	List Price (\$)	Wt. (lb.)
3	CDMJFB2203Z	24	POA	18
4	CDMJFB2204Z	100	194.00	27
6	CDMJFB2206Z	48	247.00	36
8	CDMJFB2208Z	27	384.00	53
10	CDMJFB2210Z	18	557.00	100
12	CDMJFB2212Z	12	809.00	145
30	CDMJFB2230Z		POA	

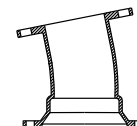
**BENDS : MJ X FE**  
**11¼° (1/32)**

Size (in)	Item No.	Crt. Qty.	List Price (\$)	Wt. (lb.)
4	CDMJFB1104Z	100	170.00	20
6	CDMJFB1106Z	48	240.00	30
8	CDMJFB1108Z	27	318.00	50
10	CDMJFB1110Z	18	522.00	74
12	CDMJFB1112Z	12	669.00	85

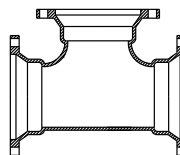
**TEES : MJ X MJ**

Size (in)	Item No.	Crt. Qty.	List Price (\$)	Wt. (lb.)
2 X 2	CDMJT0202Z		POA	22
3 X 2	CDMJT0302Z		POA	43
3 X 3	CDMJT0303Z	50	155.00	28
4 X 2	CDMJT0402Z	36	POA	29
4 X 3	CDMJT0403Z	16	182.00	35
4 X 4	CDMJT0404Z	60	170.00	32
6 X 2	CDMJT0602Z		POA	42
6 X 3	CDMJT0603Z	12	226.00	42
6 X 4	CDMJT0604Z	36	276.00	46
6 X 4 X 6	CDMJT060406Z	12	POA	60

Size (in)	Item No.	Crt. Qty.	List Price (\$)	Wt. (lb.)
6 X 6	CDMJT0606Z	24	299.00	56
6 X 6 X 8	CDMJT060608Z	25	POA	75
8 X 3	CDMJT0803Z	9	350.00	52
8 X 4	CDMJT0804Z	27	319.00	60
8 X 6	CDMJT0806Z	18	372.00	72
8 X 6 X 6	CDMJT080606Z	9	POA	75
8 X 6 X 8	CDMJT080608Z	9	POA	85
8 X 8	CDMJT0808Z	18	449.00	86
10 X 3	CDMJT1003Z	6	456.00	75
10 X 4	CDMJT1004Z	18	474.00	78

\* AWWA C110

Contd.....



## TEES : MJ X FE

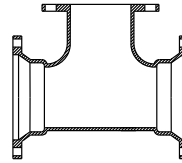

Size (in)	Item No.	Crt. Qty.	List Price (\$)	Wt. (lb.)
3 X 3	CDMJFT0303Z	40	196.00	30
4 X 2	CDMJFT0402Z		POA	53
4 X 3	CDMJFT0403Z	16	218.00	34
4 X 4	CDMJFT0404Z	36	215.00	38
6 X 3	CDMJFT0603Z	12	318.00	51
6 X 4	CDMJFT0604Z	36	334.00	54
6 X 6	CDMJFT0606Z	24	359.00	62
8 X 4	CDMJFT0804Z	27	397.00	79
8 X 6	CDMJFT0806Z	18	414.00	80
8 X 8	CDMJFT0808Z	18	527.00	90
10X 4	CDMJFT1004Z	6	546.00	89
10X 6	CDMJFT1006Z	8	684.00	110
10X 8	CDMJFT1008Z	6	735.00	115
10X10	CDMJFT1010Z	4	919.00	130
12X 4	CDMJFT1204Z	8	733.00	117
12X 6	CDMJFT1206Z	8	783.00	133
12X 8	CDMJFT1208Z	8	884.00	135
12X10	CDMJFT1210Z	4	985.00	150
12X12	CDMJFT1212Z	4	1,219.00	170
14X 6	CDMJFT1406Z	8	1,237.00	185
14X 8	CDMJFT1408Z		POA	225
14X10	CDMJFT1410Z	8	1,722.00	244
14X12	CDMJFT1412Z	8	1,892.00	284
14X14	CDMJFT1414Z	8	2,068.00	305
16X 6	CDMJFT1606Z	2	1,397.00	210
16X 8	CDMJFT1608Z	2	1,678.00	260
16X10	CDMJFT1610Z	4	2,017.00	287
16X12	CDMJFT1612Z	4	2,079.00	312

Size (in)	Item No.	Crt. Qty.	List Price (\$)	Wt. (lb.)
16X14	CDMJFT1614Z	4	POA	348
16X16	CDMJFT1616Z	4	2,872.00	374
18X 6	CDMJFT1806Z	4	1,684.00	320
18X 8	CDMJFT1808Z	4	2,207.00	352
18X12	CDMJFT1812Z		POA	358
18X18	CDMJFT1818Z		POA	445
20X 6	CDMJFT2006Z	4	2,346.00	362
20X 8	CDMJFT2008Z		POA	384
20X10	CDMJFT2010Z		POA	
24X 6	CDMJFT2406Z	2	2,678.00	408
24X 8	CDMJFT2408Z		POA	472
24X12	CDMJFT2412Z	2	3,764.00	580
24X16	CDMJFT2416Z	2	4,736.00	745
24X18	CDMJFT2418Z		POA	
24X20	CDMJFT2420Z		POA	
24X24	CDMJFT2424Z		POA	923
30X 6	CDMJFT3006Z		POA	805
30X 8	CDMJFT3008Z		POA	695
30X12	CDMJFT3012Z		POA	715
30X16	CDMJFT3016Z		POA	1187
30X24	CDMJFT3024Z		POA	
36X 6	CDMJFT3606Z		9,560.00	1175
36X12	CDMJFT3612Z		POA	
36X16	CDMJFT3616Z		POA	1475
36X36	CDMJFT3636Z		POA	
42X24	CDMJFT4224Z		POA	
42X30	CDMJFT4230Z		POA	

## MJ X SWIVEL HYDRANT TEE (W/SWIVEL GLAND) ANCHOR TEE

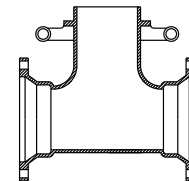

Size (in)	Item No.	Crt. Qty.	List Price (\$)	Wt. (lb.)
4 X 4	CDMJHT0404Z		POA	
6 X 6	CDMJHT0606Z	24	346.00	66
8 X 6	CDMJHT0806Z	18	432.00	86
8 X 8	CDMJHT0808Z	16	628.00	105
10X 6	CDMJHT1006Z	12	533.00	110
10X 8	CDMJHT1008Z	4	713.00	120
12X 6	CDMJHT1206Z	8	617.00	128

Size (in)	Item No.	Crt. Qty.	List Price (\$)	Wt. (lb.)
12X 8	CDMJHT1208Z	4	889.00	130
14X 6	CDMJHT1406Z	8	1,403.00	211
16X 6	CDMJHT1606Z	4	1,094.00	280
16X 8	CDMJHT1608Z	4	POA	298
18X 6	CDMJHT1806Z		1,808.00	280
20X 6	CDMJHT2006Z		1,797.00	360
24X 6	CDMJHT2406Z		2,595.00	465

\* AWWA C110

**CROSSES : MJ X MJ**

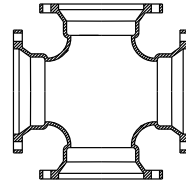

Size (in)	Item No.	Crt. Qty.	List Price (\$)	Wt. (lb.)
3 X 3	CDMJX0303Z		202.00	40
4 X 3	CDMJX0403Z		240.00	49
4 X 4	CDMJX0404Z	12	343.00	42
6 X 4	CDMJX0604Z	6	373.00	68
6 X 6	CDMJX0606Z	16	433.00	80
8 X 4	CDMJX0804Z	6	592.00	100
8 X 6	CDMJX0806Z	12	434.00	105
8 X 8	CDMJX0808Z	12	463.00	110
10X 4	CDMJX1004Z	4	576.00	120
10X 6	CDMJX1006Z	12	558.00	125
10X 8	CDMJX1008Z	8	692.00	130
10X10	CDMJX1010Z	8	730.00	145
12X 4	CDMJX1204Z	8	713.00	123
12X 6	CDMJX1206Z	8	702.00	140
12X 8	CDMJX1208Z	8	808.00	155
12X10	CDMJX1210Z	4	1,276.00	187
12X12	CDMJX1212Z	8	1,276.00	215
14X 6	CDMJX1406Z	8	1,273.00	210
14X 8	CDMJX1408Z	8	1,438.00	230
14X10	CDMJX1410Z		14x10	255
14X12	CDMJX1412Z		2,415.00	270
14X14	CDMJX1414Z	4	2,206.00	336
16X 6	CDMJX1606Z	4	1,529.00	250
16X 8	CDMJX1608Z		1,768.00	264
16X10	CDMJX1610Z		2,272.00	285
16X12	CDMJX1612Z		2,429.00	310
16X16	CDMJX1616Z		3,534.00	390
18X 6	CDMJX1806Z		POA	

Size (in)	Item No.	Crt. Qty.	List Price (\$)	Wt. (lb.)
18X12	CDMJX1812Z		POA	437
18X18	CDMJX1818Z		POA	657
20X 8	CDMJX2008Z		POA	440
20X12	CDMJX2012Z		POA	558
20X18	CDMJX2018Z		POA	698
20X20	CDMJX2020Z		POA	798
24X 6	CDMJX2406Z		POA	481
24X 8	CDMJX2408Z		POA	500
24X12	CDMJX2412Z		POA	620
24X16	CDMJX2416Z		POA	720
24X18	CDMJX2418Z		POA	868
24X20	CDMJX2420Z		POA	1014
24X24	CDMJX2424Z		5,908.00	1038
30X12	CDMJX3012Z		POA	1130
30X16	CDMJX3016Z		POA	
30X24	CDMJX3024Z		POA	1640
30X30	CDMJX3030Z		POA	1840
36X24	CDMJX3624Z		16,808.00	1955
36X36	CDMJX3636Z		18,670.00	2655
42X24	CDMJX4224Z		POA	
42X30	CDMJX4230Z		POA	
42X36	CDMJX4236Z		POA	3375
42X42	CDMJX4242Z		POA	
48X24	CDMJX4824Z		POA	
48X30	CDMJX4830Z		POA	4506
48X36	CDMJX4836Z		POA	4700
48X42	CDMJX4842Z		POA	
48X48	CDMJX4848Z		POA	5000

**TEES : MJ X PE X MJ**

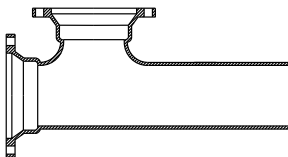

Size (in)	Item No.	Crt. Qty.	List Price (\$)	Wt. (lb.)
6	CDMJPEMJT06Z		334.00	57
8 X 6	CDMJPEMJT0806Z		433.00	69
8	CDMJPEMJT08Z	9	494.00	77
10	CDMJPEMJT10Z		754.00	120
12	CDMJPEMJT12Z		POA	

\* AWWA C110

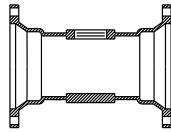
**TEES : MJ TAPPED 2"**

Size (in)	Item No.	Crt. Qty.	List Price (\$)	Wt. (lb.)
3	CDMJTT0303Z	48	174.00	18
4	CDMJTT0404Z	48	202.00	25
6	CDMJTT0606Z	48	246.00	35
8	CDMJTT0808Z	36	382.00	55
10	CDMJTT1010Z	18	783.00	70
12	CDMJTT1212Z	8	1,065.00	85
16	CDMJTT1616Z		1,148.00	164

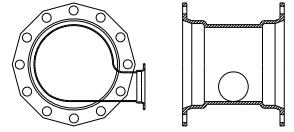
**TEES : MJ TANGENTIAL**

Size (in)	Item No.	Crt. Qty.	List Price (\$)	Wt. (lb.)
16 X 6	CDMJTLT1606Z		POA	270
16 X 12	CDMJTLT1612Z		POA	344
18 X 6	CDMJTLT1806Z		POA	306
24 X 6	CDMJTLT2406Z		POA	375
24 X 12	CDMJTLT2412Z		POA	450

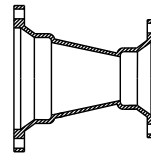
**REDUCERS : MJ X MJ**

Size (in)	Item No.	Crt. Qty.	List Price (\$)	Wt. (lb.)
3 X 2	CDMJR0302Z		POA	26
4 X 2	CDMJR0402Z	36	POA	35
4 X 3	CDMJR0403Z	80	107.00	18
6 X 2	CDMJR0602Z		POA	45
6 X 3	CDMJR0603Z	32	142.00	26
6 X 4	CDMJR0604Z	64	120.00	24
8 X 4	CDMJR0804Z	36	163.00	32
8 X 6	CDMJR0806Z	36	175.00	36
10 X 4	CDMJR1004Z	9	256.00	46
10 X 6	CDMJR1006Z	27	224.00	47
10 X 8	CDMJR1008Z	24	246.00	50
12 X 4	CDMJR1204Z	18	326.00	58
12 X 6	CDMJR1206Z	18	296.00	60
12 X 8	CDMJR1208Z	18	304.00	60
12 X 10	CDMJR1210Z	18	330.00	64
14 X 6	CDMJR1406Z	4	674.00	110
14 X 8	CDMJR1408Z	12	668.00	115
14 X 10	CDMJR1410Z	12	527.00	120
14 X 12	CDMJR1412Z	4	527.00	130
16 X 6	CDMJR1606Z	4	766.00	140
16 X 8	CDMJR1608Z	4	738.00	155
16 X 10	CDMJR1610Z	4	712.00	160
16 X 12	CDMJR1612Z	6	685.00	161
16 X 14	CDMJR1614Z	4	869.00	165
18 X 4	CDMJR1804Z		POA	
18 X 8	CDMJR1808Z		1,055.00	200

Size (in)	Item No.	Crt. Qty.	List Price (\$)	Wt. (lb.)
18 X 10	CDMJR1810Z		1,034.00	195
18 X 12	CDMJR1812Z		1,006.00	180
18 X 14	CDMJR1814Z		1,316.00	200
18 X 16	CDMJR1816Z	2	1,066.00	195
20 X 6	CDMJR2006Z		POA	232
20 X 8	CDMJR2008Z		POA	227
20 X 10	CDMJR2010Z		1,400.00	220
20 X 12	CDMJR2012Z		1,118.00	205
20 X 14	CDMJR2014Z		1,115.00	200
20 X 16	CDMJR2016Z		1,034.00	215
20 X 18	CDMJR2018Z	2	1,373.00	225
24 X 8	CDMJR2408Z		POA	
24 X 10	CDMJR2410Z		POA	
24 X 12	CDMJR2412Z		1,714.00	305
24 X 14	CDMJR2414Z		3,405.00	310
24 X 16	CDMJR2416Z		1,779.00	320
24 X 18	CDMJR2418Z		1,695.00	305
24 X 20	CDMJR2420Z		2,028.00	320
30 X 12	CDMJR3012Z		POA	705
30 X 16	CDMJR3016Z		POA	633
30 X 18	CDMJR3018Z		POA	658
30 X 20	CDMJR3020Z		POA	628
30 X 24	CDMJR3024Z		2,848.00	478
36 X 12	CDMJR3612Z		POA	1037
36 X 16	CDMJR3616Z		POA	1078
36 X 18	CDMJR3618Z		POA	1329

\* AWWA C110

Contd.....

**REDUCERS : MJ X MJ**

Contd.....

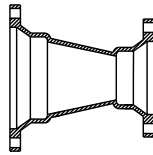

Size (in)	Item No.	Crt. Qty.	List Price (\$)	Wt. (lb.)
36X20	CDMJR3620Z		POA	975
36X24	CDMJR3624Z		4,586.00	770
36X30	CDMJR3630Z		4,988.00	650
42X16	CDMJR4216Z		POA	
42X18	CDMJR4218Z		POA	
42X20	CDMJR4220Z		POA	
42X24	CDMJR4224Z		8,497.00	1356
42X30	CDMJR4230Z		6,687.00	1083
42X36	CDMJR4236Z		6,992.00	1114
48X16	CDMJR4816Z		POA	
48X18	CDMJR4818Z		POA	
48X20	CDMJR4820Z		POA	
48X24	CDMJR4824Z		9,628.00	1700
48X30	CDMJR4830Z		11,603.00	1779
48X36	CDMJR4836Z		10,222.00	1641
48X42	CDMJR4842Z		10,865.00	1462

**REDUCERS : PE X PE**

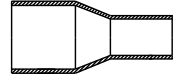

Size (in)	Item No.	Crt. Qty.	List Price (\$)	Wt. (lb.)
4 X 3	CDMJRP0403Z	48	90.00	16
6 X 3	CDMJRP0603Z	48	144.00	22
6 X 4	CDMJRP0604Z	25	142.00	30
8 X 4	CDMJRP0804Z	36	207.00	34
8 X 6	CDMJRP0806Z	16	218.00	40
10X 6	CDMJRP1006Z	9	287.00	46
10X 8	CDMJRP1008Z	9	295.00	49
12X 4	CDMJRP1204Z		363.00	58
12X 6	CDMJRP1206Z	9	363.00	59
12X 8	CDMJRP1208Z	9	373.00	59
12X10	CDMJRP1210Z	9	345.00	62
14X12	CDMJRP1412Z		523.00	95
16X 6	CDMJRP1606Z		615.00	128
16X 8	CDMJRP1608Z		798.00	130
16X10	CDMJRP1610Z		786.00	129
16X12	CDMJRP1612Z		654.00	115
16X14	CDMJRP1614Z		920.00	133
18X10	CDMJRP1810Z		POA	
18X12	CDMJRP1812Z		POA	
20X12	CDMJRP2012Z		POA	
20X16	CDMJRP2016Z		POA	
24X 8	CDMJRP2408Z		POA	
24X20	CDMJRP2420Z		POA	
30X16	CDMJRP3016Z		POA	690

**REDUCERS : MJ X FE**

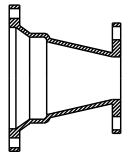

Size (in)	Item No.	Crt. Qty.	List Price (\$)	Wt. (lb.)
4 X 3	CDMJFR0403Z		POA	17
6 X 4	CDMJFR0604Z	32	POA	23
8 X 6	CDMJFR0806Z	18	POA	34
12X 8	CDMJFR1208Z		POA	58
18X 8	CDMJFR1808Z		POA	190
18X12	CDMJFR1812Z		POA	198
24X12	CDMJFR2412Z		POA	318

**REDUCERS : MJ LARGE END (LEB)**

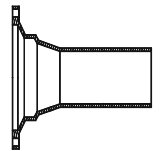

Size (in)	Item No.	Crt. Qty.	List Price (\$)	Wt. (lb.)
3 X 2	CDMJRL0302Z		POA	20
4 X 2	CDMJRL0402Z		POA	30
4 X 3	CDMJRL0403Z	40	112.00	18
6 X 3	CDMJRL0603Z	30	159.00	30
6 X 4	CDMJRL0604Z	60	178.00	26
8 X 4	CDMJRL0804Z	50	210.00	35
8 X 6	CDMJRL0806Z	48	180.00	33
10X 4	CDMJRL1004Z	4	268.00	44
10X 6	CDMJRL1006Z	18	280.00	48
10X 8	CDMJRL1008Z	16	305.00	50

**MJ PE CUTTING SLEEVES**

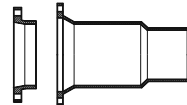

Size (in)	Item No.	Crt. Qty.	List Price (\$)	Wt. (lb.)
4	CDMJPESC04Z	36	POA	50
6	CDMJPESC06Z	18	POA	62
8	CDMJPESC08Z	18	POA	90
10	CDMJPESC10Z	8	POA	105
12	CDMJPESC12Z	8	POA	128
16	CDMJPESC16Z		POA	275

\* AWWA C110

Contd.....

ZINC ZINC ZINC ZINC ZINC ZINC ZINC



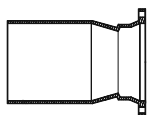

**REDUCERS : MJ SMALL  
END (SEB)** Contd.....

Size (in)	Item No.	Crt. Qty.	List Price (\$)	Wt. (lb.)
24X16	CDMJRS2416Z		1,877.00	285
24X18	CDMJRS2418Z		2,095.00	300
24X20	CDMJRS2420Z		1,992.00	270
30X16	CDMJRS3016Z		POA	565
30X18	CDMJRS3018Z		POA	648
30X20	CDMJRS3020Z		POA	560
30X24	CDMJRS3024Z		POA	536
36X16	CDMJRS3616Z		POA	620
36X20	CDMJRS3620Z		POA	874
36X24	CDMJRS3624Z		POA	790
36X30	CDMJRS3630Z		POA	788
42X24	CDMJRS4224Z		POA	1204
42X30	CDMJRS4230Z		POA	931
42X36	CDMJRS4236Z		POA	1023
48X30	CDMJRS4830Z		POA	1625

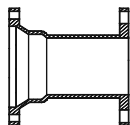
**ADAPTERS : MJ X FLANGE**

Size (in)	Item No.	Crt. Qty.	List Price (\$)	Wt. (lb.)
3	CDMJFA03Z	150	100.00	14
4	CDMJFA04Z	120	128.00	23
6	CDMJFA06Z	45	166.00	30
8	CDMJFA08Z	45	253.00	46
10	CDMJFA10Z	30	433.00	62
12	CDMJFA12Z	24	555.00	98
14	CDMJFA14Z	20	836.00	143
16	CDMJFA16Z	10	968.00	170
18	CDMJFA18Z	2	1,406.00	220
20	CDMJFA20Z	10	1,738.00	240
24	CDMJFA24Z	2	2,094.00	322
30	CDMJFA30Z		3,883.00	544
36	CDMJFA36Z		5,563.00	798
42	CDMJFA42Z		POA	1214
48	CDMJFA48Z		POA	1600

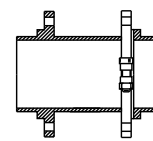
**HYDRANT ADAPTERS :  
SWIVEL X SOLID  
WITH SWIVEL GLAND  
(ANCHOR COUPLING)**

Size (in)	Item No.	Crt. Qty.	List Price (\$)	Wt. (lb.)
4 X 13	CDMJHA0413Z	18	POA	29
6 X 13	CDMJHA0613Z	36	325.00	46
6 X 18	CDMJHA0618Z	24	362.00	55
6 X 24	CDMJHA0624Z	24	480.00	59
6 X 36	CDMJHA0636Z	6	POA	75
6 X 48	CDMJHA0648Z		POA	94
8 X 13	CDMJHA0813Z	24	432.00	54
8 X 18	CDMJHA0818Z		POA	67
8 X 24	CDMJHA0824Z		POA	82
8 X 48	CDMJHA0848Z		POA	143
12 X 13	CDMJHA1213Z	8	POA	120

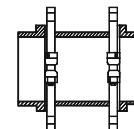
**HYDRANT ADAPTERS :  
SWIVEL X SWIVEL  
WITH TWO-SWIVEL GLAND**

Size (in)	Item No.	Crt. Qty.	List Price (\$)	Wt. (lb.)
6 X 12	CDMJHHA0612Z		POA	30
6 X 18	CDMJHHA0618Z		POA	49
6 X 24	CDMJHHA0624Z		POA	52

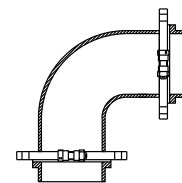
**HYDRANT ELL :  
SWIVEL X SWIVEL  
WITH TWO-SWIVEL GLAND**

Size (in)	Item No.	Crt. Qty.	List Price (\$)	Wt. (lb.)
6	CDMJHB9006Z	24	POA	50

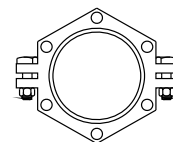
**SWIVEL GLAND**

Size (in)	Item No.	Crt. Qty.	List Price (\$)	Wt. (lb.)
4	CDMJGS04Z	100	POA	8
6	CDMJGS06Z	100	POA	9
8	CDMJGS08Z	100	POA	11
12	CDMJGS12Z	50	POA	24

\* AWWA C110

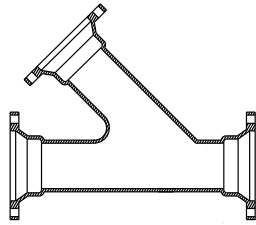
**MJ 45° LATERAL  
(WYES)**

Size (in)	Item No.	Crt. Qty.	List Price (\$)	Wt. (lb.)
3 X 3	CDMJL0303Z		209.00	36
4 X 2	CDMJL0402Z		POA	
4 X 3	CDMJL0403Z		232.00	40
4 X 4	CDMJL0404Z	30	268.00	42
6 X 4	CDMJL0604Z	12	277.00	53
6 X 6	CDMJL0606Z	16	407.00	85
8 X 4	CDMJL0804Z	6	559.00	75
8 X 6	CDMJL0806Z	6	469.00	92
8 X 8	CDMJL0808Z	6	588.00	105
10X 4	CDMJL1004Z	4	908.00	147
10X 6	CDMJL1006Z	4	957.00	156
10X 8	CDMJL1008Z	4	1,040.00	172
10X10	CDMJL1010Z	4	1,269.00	212
12X 4	CDMJL1204Z	2	1,293.00	185
12X 6	CDMJL1206Z	2	1,345.00	187
12X 8	CDMJL1208Z	2	1,445.00	190
12X10	CDMJL1210Z	2	1,696.00	245
12X12	CDMJL1212Z	2	1,564.00	275
14X 6	CDMJL1406Z	2	2,280.00	
14X 8	CDMJL1408Z	2	POA	
14X10	CDMJL1410Z	2	POA	
14X14	CDMJL1414Z	2	2,766.00	474
16X 6	CDMJL1606Z	2	1,823.00	300
16X 8	CDMJL1608Z	2	2,136.00	349
16X10	CDMJL1610Z		POA	
16X12	CDMJL1612Z		2,742.00	453
16X16	CDMJL1616Z	2	3,333.00	575
18X 6	CDMJL1806Z		POA	408
18X10	CDMJL1810Z		POA	485
18X12	CDMJL1812Z		POA	510
18X18	CDMJL1818Z		POA	808
20X20	CDMJL2020Z		POA	1525
24X10	CDMJL2410Z		POA	1800
24X12	CDMJL2412Z		POA	900
24X16	CDMJL2416Z		POA	1815
24X18	CDMJL2418Z		POA	1047
24X24	CDMJL2424Z		POA	1269
30X20	CDMJL3020Z		POA	2575
30X24	CDMJL3024Z		POA	1575

Size (in)	Item No.	Crt. Qty.	List Price (\$)	Wt. (lb.)
30X30	CDMJL3030Z		POA	1269
36X 8	CDMJL3608Z		POA	1430
36X20	CDMJL3620Z		POA	2032
36X30	CDMJL3630Z		POA	5080
36X36	CDMJL3636Z		POA	2280
42X24	CDMJL4224Z		POA	3400
42X42	CDMJL4242Z		POA	4438
48X18	CDMJL4818Z		POA	3502
48X20	CDMJL4820Z		POA	3695
48X24	CDMJL4824Z		POA	4313
48X30	CDMJL4830Z		POA	4522
48X48	CDMJL4848Z		POA	5907

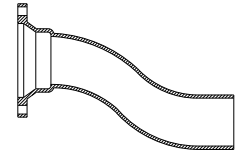
**MJ X PE OFFSET**

Size (in)	Item No.	Crt. Qty.	List Price (\$)	Wt. (lb.)
3 X 6	CDMJOP0306Z		POA	32
3 X 12	CDMJOP0312Z		POA	42
3 X 18	CDMJOP0318Z		POA	54
3 X 24	CDMJOP0324Z		POA	58
4 X 6	CDMJOP0406Z	12	POA	45
4 X 12	CDMJOP0412Z	12	POA	56
4 X 18	CDMJOP0418Z	16	POA	62
4 X 24	CDMJOP0424Z	6	POA	70
6 X 6	CDMJOP0606Z	12	POA	55
6 X 12	CDMJOP0612Z	8	POA	68
6 X 18	CDMJOP0618Z	8	POA	97
6 X 24	CDMJOP0624Z	4	POA	116
8 X 6	CDMJOP0806Z	4	POA	84
8 X 12	CDMJOP0812Z	4	POA	110
8 X 18	CDMJOP0818Z	4	POA	124
8 X 24	CDMJOP0824Z	3	POA	147
10 X 6	CDMJOP1006Z	6	POA	127
10 X 12	CDMJOP1012Z	4	POA	130
10 X 18	CDMJOP1018Z	4	POA	160
10 X 24	CDMJOP1024Z	4	POA	169
12 X 6	CDMJOP1206Z	4	POA	115
12 X 12	CDMJOP1212Z	4	POA	198
12 X 18	CDMJOP1218Z	4	POA	270
12 X 24	CDMJOP1224Z	2	POA	335
12 X 30	CDMJOP1230Z		POA	225

\* AWWA C110

**MJ OFFSET**

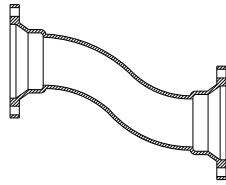

Size (in)	Item No.	Crt. Qty.	List Price (\$)	Wt. (lb.)
3 X 6	CDMJO0306Z		POA	30
3 X 12	CDMJO0312Z		POA	40
3 X 18	CDMJO0318Z		POA	49
3 X 24	CDMJO0324Z		POA	55
4 X 6	CDMJO0406Z	12	POA	25
4 X 12	CDMJO0412Z	12	POA	55
4 X 18	CDMJO0418Z	8	POA	65
4 X 24	CDMJO0424Z	16	POA	75
6 X 6	CDMJO0606Z	12	POA	29
6 X 12	CDMJO0612Z	16	POA	69
6 X 18	CDMJO0618Z	8	POA	87
6 X 24	CDMJO0624Z	8	POA	107
8 X 6	CDMJO0806Z	4	POA	80
8 X 12	CDMJO0812Z	4	POA	104
8 X 18	CDMJO0818Z	4	POA	135
8 X 24	CDMJO0824Z	3	POA	141
10 X 6	CDMJO1006Z	4	POA	110
10 X 12	CDMJO1012Z	4	POA	135
10 X 18	CDMJO1018Z	4	POA	165
10 X 24	CDMJO1024Z	4	POA	175
12 X 6	CDMJO1206Z	4	POA	118
12 X 12	CDMJO1212Z	4	POA	203
12 X 18	CDMJO1218Z	4	POA	230
12 X 24	CDMJO1224Z	2	POA	277
12 X 30	CDMJO1230Z		POA	285
16 X 12	CDMJO1612Z		POA	305
16 X 18	CDMJO1618Z		POA	362
20 X 12	CDMJO2012Z		POA	437
20 X 18	CDMJO2018Z		POA	581

**MJ LONG SLEEVES**

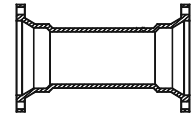

Size (in)	Item No.	Crt. Qty.	List Price (\$)	Wt. (lb.)
2	CDMJLS02Z	50	POA	7
3	CDMJLS03Z	126	102.00	18
4	CDMJLS04Z	75	110.00	20
6	CDMJLS06Z	36	194.00	36
8	CDMJLS08Z	27	306.00	46
10	CDMJLS10Z	18	362.00	62
12	CDMJLS12Z	12	472.00	76
14	CDMJLS14Z	8	735.00	140
16	CDMJLS16Z	8	929.00	172
18	CDMJLS18Z	5	1,170.00	225
20	CDMJLS20Z	5	1,415.00	255
24	CDMJLS24Z	5	1,862.00	335
30	CDMJLS30Z		3,835.00	694
36	CDMJLS36Z		4,764.00	1016
42	CDMJLS42Z		7,097.00	1390
48	CDMJLS48Z		9,763.00	1740

**MJ SHORT SLEEVES**

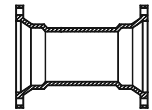

Size (in)	Item No.	Crt. Qty.	List Price (\$)	Wt. (lb.)
2	CDMJSS02Z		POA	12
3	CDMJSS03Z	50	80.00	13
4	CDMJSS04Z	125	78.00	17
6	CDMJSS06Z	60	139.00	28
8	CDMJSS08Z	45	182.00	38
10	CDMJSS10Z	30	317.00	49
12	CDMJSS12Z	20	357.00	56
14	CDMJSS14Z	16	667.00	111
16	CDMJSS16Z	16	828.00	130
18	CDMJSS18Z	2	1,034.00	160
20	CDMJSS20Z	8	1,265.00	195
24	CDMJSS24Z	2	1,672.00	255
30	CDMJSS30Z		3,397.00	500
36	CDMJSS36Z		4,609.00	725
42	CDMJSS42Z		POA	877
48	CDMJSS48Z		POA	1406

\* AWWA C110

**MJ CAPS : SOLID**

Size (in)	Item No.	Crt. Qty.	List Price (\$)	Wt. (lb.)
2	CDMJC02Z		POA	6
3	CDMJC03Z	300	46.00	8
4	CDMJC04Z	240	49.00	10
6	CDMJC06Z	144	88.00	17
8	CDMJC08Z	108	135.00	22
10	CDMJC10Z	72	176.00	32
12	CDMJC12Z	52	254.00	42
14	CDMJC14Z	36	387.00	70
16	CDMJC16Z	20	518.00	98
18	CDMJC18Z	20	633.00	120
20	CDMJC20Z	20	806.00	130
24	CDMJC24Z	10	1,107.00	170
30	CDMJC30Z	2	2,463.00	385
36	CDMJC36Z	2	4,378.00	614
42	CDMJC42Z		POA	893
48	CDMJC48Z		POA	1067

**MJ CAPS : 2" TAPPED**

Size (in)	Item No.	Crt. Qty.	List Price (\$)	Wt. (lb.)
2	CDMJCT02Z		POA	10
3	CDMJCT03Z	300	87.00	8
4	CDMJCT04Z	240	89.00	10
6	CDMJCT06Z	144	128.00	17
8	CDMJCT08Z	108	174.00	22
10	CDMJCT10Z	72	215.00	32
12	CDMJCT12Z	52	294.00	42
14	CDMJCT14Z	36	456.00	70
16	CDMJCT16Z	20	579.00	98
18	CDMJCT18Z	20	718.00	120
20	CDMJCT20Z	20	898.00	130
24	CDMJCT24Z	10	1,170.00	170
30	CDMJCT30Z	2	2,579.00	385
36	CDMJCT36Z	2	4,494.00	614
42	CDMJCT42Z		POA	893
48	CDMJCT48Z		POA	1076

**MJ PLUGS : SOLID**



Size (in)	Item No.	Crt. Qty.	List Price (\$)	Wt. (lb.)
2	CDMJP02Z		POA	6
3	CDMJP03Z	100	65.00	8
4	CDMJP04Z	100	59.00	10
6	CDMJP06Z	144	109.00	22
8	CDMJP08Z	66	160.00	32
10	CDMJP10Z	52	275.00	40
12	CDMJP12Z	40	280.00	55
14	CDMJP14Z	16	580.00	70
16	CDMJP16Z	10	743.00	105
18	CDMJP18Z	4	922.00	125
20	CDMJP20Z	4	1,193.00	139
24	CDMJP24Z	4	1,655.00	180
30	CDMJP30Z	2	3,229.00	433
36	CDMJP36Z	2	4,988.00	674
42	CDMJP42Z		6,839.00	1067
48	CDMJP48Z		9,118.00	1313

**MJ PLUGS : 2" TAPPED**

Size (in)	Item No.	Crt. Qty.	List Price (\$)	Wt. (lb.)
2	CDMJPT02Z		POA	5
3	CDMJPT03Z	300	103.00	8
4	CDMJPT04Z	240	98.00	10
6	CDMJPT06Z	144	148.00	22
8	CDMJPT08Z	108	199.00	32
10	CDMJPT10Z	66	314.00	40
12	CDMJPT12Z	24	319.00	55
14	CDMJPT14Z	32	607.00	70
16	CDMJPT16Z	20	782.00	105
18	CDMJPT18Z	20	946.00	125
20	CDMJPT20Z	20	1,188.00	139
24	CDMJPT24Z	10	1,603.00	180
30	CDMJPT30Z	2	3,225.00	433
36	CDMJPT36Z	2	4,939.00	674
42	CDMJPT42Z		6,977.00	1067
48	CDMJPT48Z		9,274.00	1313

\* AWWA C110

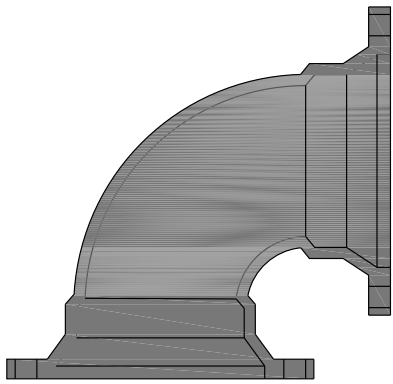
# Utility Pipe Fittings Zinc Coated



ANSI/AWWA C110/A21.10  
**FULL BODY MJ FITTINGS**  
**ZINC COATED**

**PRICE LIST**  
Effective January 14, 2019.

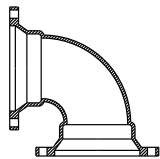

**BENDS : MJ X MJ**  
**90° (1/4)**

Size (in)	Item No.	Crt. Qty.	List Price (\$)	Wt. (lb.)
2	XDMJB9002Z	36	234.00	14
3	XDMJB9003Z	36	215.00	35
4	XDMJB9004Z	24	284.00	55
6	XDMJB9006Z	12	436.00	85
8	XDMJB9008Z	12	698.00	125
10	XDMJB9010Z	4	1,179.00	190
12	XDMJB9012Z	4	1,346.00	255
14	XDMJB9014Z	0	2,445.00	380
16	XDMJB9016Z	0	2,934.00	430
18	XDMJB9018Z	0	4,173.00	545
20	XDMJB9020Z	0	4,715.00	680
24	XDMJB9024Z	0	6,180.00	1025
30	XDMJB9030Z	0	10,972.00	1690
36	XDMJB9036Z	0	14,962.00	2475
42	XDMJB9042Z	0	25,080.00	3410
48	XDMJB9048Z	0	33,795.00	4595

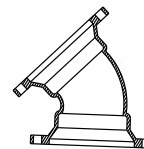
**BENDS :MJ X MJ**  
**45° (1/8)**

Size (in)	Item No.	Crt. Qty.	List Price (\$)	Wt. (lb.)
2	XDMJB4502Z	36	163.00	13
3	XDMJB4503Z	0	184.00	30
4	XDMJB4504Z	36	257.00	50
6	XDMJB4506Z	12	389.00	75
8	XDMJB4508Z	12	574.00	110
10	XDMJB4510Z	4	877.00	155
12	XDMJB4512Z	4	1,133.00	215
14	XDMJB4514Z	0	1,778.00	270
16	XDMJB4516Z	0	2,263.00	340
18	XDMJB4518Z	0	2,886.00	420
20	XDMJB4520Z	0	3,098.00	530
24	XDMJB4524Z	0	4,349.00	755
30	XDMJB4530Z	0	8,636.00	1380
36	XDMJB4536Z	0	12,955.00	2095
42	XDMJB4542Z	0	21,735.00	2955
48	XDMJB4548Z	0	30,008.00	4080

**BENDS : MJ X MJ**  
**22½° (1/16)**



Size (in)	Item No.	Crt. Qty.	List Price (\$)	Wt. (lb.)
2	XDMJB2202Z	0	POA	13
3	XDMJB2203Z	0	184.00	30
4	XDMJB2204Z	12	299.00	50
6	XDMJB2206Z	12	403.00	75
8	XDMJB2208Z	12	780.00	110
10	XDMJB2210Z	4	967.00	160
12	XDMJB2212Z	4	1,186.00	220
14	XDMJB2214Z	0	1,812.00	275
16	XDMJB2216Z	0	2,240.00	345
18	XDMJB2218Z	0	2,829.00	430
20	XDMJB2220Z	0	3,707.00	535
24	XDMJB2224Z	0	4,280.00	765
30	XDMJB2230Z	0	8,323.00	1400
36	XDMJB2236Z	0	12,625.00	2135
42	XDMJB2242Z	0	22,213.00	3020
48	XDMJB2248Z	0	30,670.00	4170

**BENDS : MJ X MJ**  
**11¼° (1/32)**

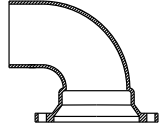

Size (in)	Item No.	Crt. Qty.	List Price (\$)	Wt. (lb.)
2	XDMJB1102Z	0	POA	13
3	XDMJB1103Z	0	180.00	30
4	XDMJB1104Z	12	299.00	50
6	XDMJB1106Z	12	449.00	75
8	XDMJB1108Z	12	588.00	110
10	XDMJB1110Z	0	967.00	160
12	XDMJB1112Z	6	1,345.00	220
14	XDMJB1114Z	0	1,812.00	275
16	XDMJB1116Z	0	2,272.00	345
18	XDMJB1118Z	0	2,927.00	430
20	XDMJB1120Z	0	3,684.00	540
24	XDMJB1124Z	0	5,009.00	770
30	XDMJB1130Z	0	9,799.00	1410
36	XDMJB1136Z	0	15,050.00	2145
42	XDMJB1142Z	0	22,324.00	3035
48	XDMJB1148Z	0	30,818.00	4190

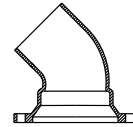
**BENDS : MJ X PE**  
**90° (1/4)**

Size (in)	Item No.	Crt. Qty.	List Price (\$)	Wt. (lb.)
3	XDMJBP9003Z	0	218.00	35
4	XDMJBP9004Z	8	312.00	50
6	XDMJBP9006Z	12	583.00	80
8	XDMJBP9008Z	12	915.00	120
10	XDMJBP9010Z	8	1,179.00	170
12	XDMJBP9012Z	4	1,580.00	255
14	XDMJBP9014Z	0	3,308.00	330
16	XDMJBP9016Z	0	2,698.00	410
18	XDMJBP9018Z	0	3,422.00	600
20	XDMJBP9020Z	0	4,275.00	775
24	XDMJBP9024Z	0	6,479.00	985
30	XDMJBP9030Z	0	11,043.00	1920
36	XDMJBP9036Z	0	16,092.00	2310
42	XDMJBP9042Z	0	26,276.00	3215
48	XDMJBP9048Z	0	45,096.00	4345

**BENDS : MJ X PE**  
**45° (1/8)**

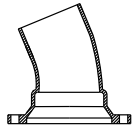
Size (in)	Item No.	Crt. Qty.	List Price (\$)	Wt. (lb.)
3	XDMJBP4503Z	24	POA	32
4	XDMJBP4504Z	50	288.00	45
6	XDMJBP4506Z	12	486.00	70
8	XDMJBP4508Z	24	735.00	105
10	XDMJBP4510Z	12	1,043.00	155
12	XDMJBP4512Z	4	1,333.00	215
14	XDMJBP4514Z	4	1,675.00	258
16	XDMJBP4516Z	4	1,956.00	320
18	XDMJBP4518Z	0	2,599.00	455
20	XDMJBP4520Z	0	3,289.00	664
24	XDMJBP4524Z	2	4,649.00	715
30	XDMJBP4530Z	0	8,884.00	1510
36	XDMJBP4536Z	0	13,445.00	1930
42	XDMJBP4542Z	0	24,312.00	2745
48	XDMJBP4548Z	0	34,858.00	3820

**BENDS : MJ X PE**  
**22½° (1/16)**

Size (in)	Item No.	Crt. Qty.	List Price (\$)	Wt. (lb.)
3	XDMJBP2203Z	24	POA	32
4	XDMJBP2204Z	24	283.00	50
6	XDMJBP2206Z	0	436.00	70
8	XDMJBP2208Z	0	654.00	105
10	XDMJBP2210Z	0	992.00	160
12	XDMJBP2212Z	0	1,363.00	220
14	XDMJBP2214Z	4	POA	335
16	XDMJBP2216Z	0	2,142.00	365
18	XDMJBP2218Z	0	2,667.00	455
20	XDMJBP2220Z	0	3,325.00	575
24	XDMJBP2224Z	0	4,770.00	930
30	XDMJBP2230Z	0	9,753.00	1540
36	XDMJBP2236Z	0	13,724.00	1970
42	XDMJBP2242Z	0	26,125.00	2815
48	XDMJBP2248Z		POA	

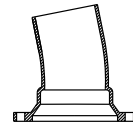
**BENDS : MJ X PE**  
**11½° (1/32)**

Size (in)	Item No.	Crt. Qty.	List Price (\$)	Wt. (lb.)
3	XDMJBP1103Z	24	POA	32
4	XDMJBP1104Z	24	570.00	50
6	XDMJBP1106Z	24	742.00	70
8	XDMJBP1108Z	16	654.00	105
12	XDMJBP1112Z	0	963.00	220
14	XDMJBP1114Z	0	3,962.00	260
16	XDMJBP1116Z	2	4,870.00	365
18	XDMJBP1118Z	0	POA	455
20	XDMJBP1120Z	0	5,765.00	575
24	XDMJBP1124Z	0	4,802.00	845
30	XDMJBP1130Z	0	9,093.00	1305
36	XDMJBP1136Z	0	13,792.00	2185
48	XDMJBP1148Z	0	37,108.00	3945

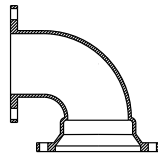
**BENDS : MJ X FE**  
**90° (1/4)**

Size (in)	Item No.	Crt. Qty.	List Price (\$)	Wt. (lb.)
4	XDMJFB9004Z	0	314.00	53
6	XDMJFB9006Z	0	438.00	75
8	XDMJFB9008Z	2	679.00	115
10	XDMJFB9010Z	0	983.00	177
12	XDMJFB9012Z	0	1,617.00	246
16	XDMJFB9016Z	0	2,816.00	465
18	XDMJFB9018Z	0	3,494.00	577
20	XDMJFB9020Z	0	POA	745
24	XDMJFB9024Z	0	7,900.00	1150

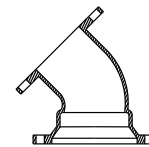
**BENDS : MJ X FE**  
**45° (1/8)**

Size (in)	Item No.	Crt. Qty.	List Price (\$)	Wt. (lb.)
4	XDMJFB4504Z	0	263.00	45
6	XDMJFB4506Z	0	409.00	69
8	XDMJFB4508Z	0	619.00	105
10	XDMJFB4510Z	0	958.00	155
12	XDMJFB4512Z	0	1,245.00	215
16	XDMJFB4516Z	0	2,829.00	360
18	XDMJFB4518Z	0	3,974.00	422
20	XDMJFB4520Z	0	6,032.00	543
24	XDMJFB4524Z	0	5,343.00	903

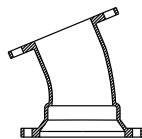
**BENDS : MJ X FE**  
**22½° (1/16)**

Size (in)	Item No.	Crt. Qty.	List Price (\$)	Wt. (lb.)
4	XDMJFB2204Z	0	POA	45
6	XDMJFB2206Z	0	360.00	69
8	XDMJFB2208Z	0	619.00	105
10	XDMJFB2210Z	0	899.00	155
12	XDMJFB2212Z	0	1,389.00	215
16	XDMJFB2216Z	0	1,958.00	373
18	XDMJFB2218Z	0	2,089.00	422
20	XDMJFB2220Z	0	5,876.00	575
24	XDMJFB2224Z	0	5,555.00	800

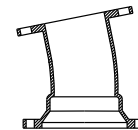
**BENDS : MJ X FE**  
**11¼° (1/32)**

Size (in)	Item No.	Crt. Qty.	List Price (\$)	Wt. (lb.)
4	XDMJFB1104Z	0	POA	45
6	XDMJFB1106Z	0	413.00	69
8	XDMJFB1108Z	0	610.00	105
10	XDMJFB1110Z	0	POA	155
12	XDMJFB1112Z	0	1,245.00	215
16	XDMJFB1116Z	0	2,214.00	360
18	XDMJFB1118Z	0	2,609.00	422
20	XDMJFB1120Z	0	POA	575
24	XDMJFB1124Z	0	5,555.00	800

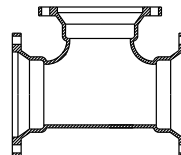
**TEES : MJ X MJ**

Size (in)	Item No.	Crt. Qty.	List Price (\$)	Wt. (lb.)
2 X 2	XDMJT0202Z	36	180.00	22
3 X 2	XDMJT0302Z		283.00	43
3 X 3	XDMJT0303Z		383.00	55
4 X 2	XDMJT0402Z	24	766.00	65
4 X 3	XDMJT0403Z		467.00	75
4 X 4	XDMJT0404Z	12	477.00	80

Size (in)	Item No.	Crt. Qty.	List Price (\$)	Wt. (lb.)
4 X 4 X 6	XDMJT040406Z		POA	115
6 X 2	XDMJT0602Z	12	635.00	100
6 X 3	XDMJT0603Z	24	657.00	110
6 X 4	XDMJT0604Z	12	688.00	115
6 X 6	XDMJT0606Z	12	669.00	125
6 X 6 X 8	XDMJT060608Z		POA	185

Contd.....

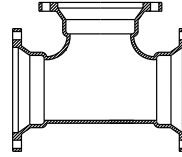

**TEES : MJ X MJ**  
Contd.....

Size (in)	Item No.	Crt. Qty.	List Price (\$)	Wt. (lb.)	Size (in)	Item No.	Crt. Qty.	List Price (\$)	Wt. (lb.)
8 X 3	XDMJT0803Z		1,258.00	155	20 X 14	XDMJT2014Z		5,230.00	795
8 X 4	XDMJT0804Z	9	987.00	165	20 X 16	XDMJT2016Z		6,145.00	945
8 X 6	XDMJT0806Z	9	929.00	175	20 X 18	XDMJT2018Z		6,479.00	985
8 X 8	XDMJT0808Z	9	1,004.00	185	20 X 20	XDMJT2020Z		5,668.00	1020
10 X 3	XDMJT1003Z		POA	216	24 X 4	XDMJT2404Z		POA	985
10 X 4	XDMJT1004Z	12	1,457.00	235	24 X 6	XDMJT2406Z		6,479.00	985
10 X 6	XDMJT1006Z	4	1,510.00	250	24 X 8	XDMJT2408Z		6,577.00	1000
10 X 8	XDMJT1008Z	4	1,570.00	260	24 X 10	XDMJT2410Z		7,832.00	1020
10 X 10	XDMJT1010Z	4	1,873.00	310	24 X 12	XDMJT2412Z		6,775.00	1030
12 X 3	XDMJT1203Z		POA	290	24 X 14	XDMJT2414Z		6,942.00	1055
12 X 4	XDMJT1204Z	8	1,926.00	315	24 X 16	XDMJT2416Z		7,150.00	1075
12 X 6	XDMJT1206Z	4	1,794.00	325	24 X 18	XDMJT2418Z		9,206.00	1400
12 X 8	XDMJT1208Z	4	2,079.00	340	24 X 20	XDMJT2420Z		11,177.00	1450
12 X 10	XDMJT1210Z	4	2,384.00	390	24 X 24	XDMJT2424Z		11,345.00	1535
12 X 12	XDMJT1212Z	4	2,496.00	410	30 X 6	XDMJT3006Z		12,050.00	1730
14 X 4	XDMJT1404Z		3,466.00	383	30 X 8	XDMJT3008Z		12,158.00	1745
14 X 6	XDMJT1406Z	4	2,863.00	435	30 X 10	XDMJT3010Z		12,260.00	1760
14 X 8	XDMJT1408Z		2,960.00	450	30 X 12	XDMJT3012Z		12,399.00	1780
14 X 10	XDMJT1410Z		3,062.00	465	30 X 14	XDMJT3014Z		17,802.00	1800
14 X 12	XDMJT1412Z		3,258.00	495	30 X 16	XDMJT3016Z		18,008.00	1820
14 X 14	XDMJT1414Z		3,422.00	520	30 X 18	XDMJT3018Z		12,854.00	1845
16 X 4	XDMJT1604Z		4,369.00	600	30 X 20	XDMJT3020Z		13,063.00	1875
16 X 6	XDMJT1606Z		3,553.00	540	30 X 24	XDMJT3024Z		16,716.00	2400
16 X 8	XDMJT1608Z		3,618.00	550	30 X 30	XDMJT3030Z		18,076.00	2595
16 X 10	XDMJT1610Z		3,750.00	570	36 X 6	XDMJT3606Z		17,414.00	2439
16 X 12	XDMJT1612Z		3,882.00	590	36 X 8	XDMJT3608Z		17,553.00	2520
16 X 14	XDMJT1614Z		4,079.00	620	36 X 10	XDMJT3610Z		POA	2535
16 X 16	XDMJT1616Z		4,524.00	650	36 X 12	XDMJT3612Z		17,764.00	2550
18 X 4	XDMJT1804Z		POA	528	36 X 14	XDMJT3614Z		17,903.00	2570
18 X 6	XDMJT1806Z		3,882.00	590	36 X 16	XDMJT3616Z		15,224.00	2585
18 X 8	XDMJT1808Z		3,982.00	605	36 X 18	XDMJT3618Z		POA	2610
18 X 10	XDMJT1810Z		4,079.00	620	36 X 20	XDMJT3620Z		18,355.00	2635
18 X 12	XDMJT1812Z		4,209.00	640	36 X 24	XDMJT3624Z		18,738.00	2690
18 X 14	XDMJT1814Z		4,969.00	755	36 X 30	XDMJT3630Z		24,695.00	3545
18 X 16	XDMJT1816Z		5,165.00	785	36 X 36	XDMJT3636Z		21,077.00	3745
18 X 18	XDMJT1818Z		5,395.00	820	42 X 6	XDMJT4206Z		POA	3440
20 X 6	XDMJT2006Z	2	5,240.00	725	42 X 12	XDMJT4212Z		26,147.00	3555
20 X 8	XDMJT2008Z	2	6,065.00	735	42 X 14	XDMJT4214Z		26,295.00	3575
20 X 10	XDMJT2010Z		4,969.00	755	42 X 16	XDMJT4216Z		26,442.00	3595
20 X 12	XDMJT2012Z	2	5,033.00	775	42 X 18	XDMJT4218Z		45,824.00	3615

Contd.....

**TEES : MJ X MJ**

Contd.....

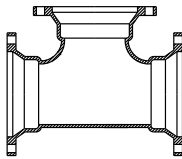

Size (in)	Item No.	Crt. Qty.	List Price (\$)	Wt. (lb.)
42 X 20	XDMJT4220Z		45,852.00	3640
42 X 24	XDMJT4224Z		27,142.00	3690
42 X 30	XDMJT4230Z		34,199.00	4650
42 X 36	XDMJT4236Z		44,680.00	6075
42 X 42	XDMJT4242Z		46,483.00	6320
48 X 12	XDMJT4812Z		50,845.00	4870
48 X 14	XDMJT4814Z		50,756.00	4885
48 X 16	XDMJT4816Z		52,666.00	4905
48 X 18	XDMJT4818Z		54,334.00	4925
48 X 20	XDMJT4820Z		49,527.00	4950
48 X 24	XDMJT4824Z		36,738.00	4995
48 X 30	XDMJT4830Z		37,804.00	5140
48 X 36	XDMJT4836Z		46,188.00	6280
48 X 42	XDMJT4842Z		59,793.00	8130
48 X 36 X 48	XDMJT483648Z		POA	6397
48 X 48	XDMJT4848Z		61,926.00	8420

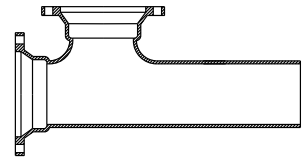
**TEES : MJ X PE X MJ**

Size (in)	Item No.	Crt. Qty.	List Price (\$)	Wt. (lb.)
4 X 4	XDMJPT0404Z		POA	75
6 X 6	XDMJPT0606Z		POA	120
8 X 4	XDMJPT0804Z	6	1,298.00	160
8 X 6	XDMJPT0806Z		POA	170
8 X 8	XDMJPT0808Z		1,116.00	180
10 X 10	XDMJPT1010Z		POA	250
12 X 4	XDMJPT1204Z		POA	315
12 X 6	XDMJPT1206Z		2,698.00	325
12 X 8	XDMJPT1208Z		2,499.00	340
12 X 10	XDMJPT1210Z		POA	390
12 X 12	XDMJPT1212Z		3,076.00	410
14 X 14	XDMJPT1414Z		3,808.00	500
16 X 8	XDMJPT1608Z	2	3,718.00	530
16 X 16	XDMJPT1616Z		4,746.00	625
24 X 6	XDMJPT2406Z	2	8,774.00	945
24 X 8	XDMJPT2408Z		8,977.00	960
24 X 12	XDMJPT2412Z		9,150.00	990
24 X 16	XDMJPT2416Z		9,512.00	1035
24 X 24	XDMJPT2424Z		13,905.00	1490
36 X 12	XDMJPT3612Z		POA	2375
36 X 24	XDMJPT3624Z		POA	2515
36 X 36	XDMJPT3636Z		POA	3565

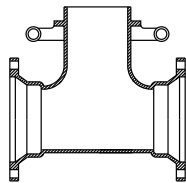
**MJ X SWIVEL  
HYDRANT TEE  
(W/SWIVEL GLAND)**

Size (in)	Item No.	Crt. Qty.	List Price (\$)	Wt. (lb.)
6 X 6	XDMJTH0606Z	9	816.00	145
8 X 6	XDMJTH0806Z	9	1,027.00	165
8 X 8	XDMJTH0808Z		1,704.00	210
10 X 6	XDMJTH1006Z		1,703.00	270
12 X 6	XDMJTH1206Z	4	2,163.00	365
12 X 8	XDMJTH1208Z	4	3,743.00	350
16 X 6	XDMJTH1606Z		3,654.00	619
16 X 8	XDMJTH1608Z		POA	649
20 X 6	XDMJTH2006Z	2	11,809.00	725
24 X 6	XDMJTH2406Z		14,553.00	973
30 X 6	XDMJTH3006Z		13,876.00	2070
36 X 6	XDMJTH3606Z		POA	2830

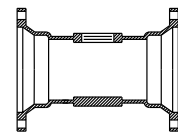
**TEES : MJ TAPPED 2"**

Size (in)	Item No.	Crt. Qty.	List Price (\$)	Wt. (lb.)
4 X 4	XDMJX0404TZ	0	322.00	45
6 X 6	XDMJX0606TZ	0	475.00	70
8 X 8	XDMJX0808TZ	0	734.00	95
10 X 10	XDMJX1010TZ	0	846.00	130
12 X 12	XDMJX1212TZ	0	1,065.00	165
16 X 16	XDMJX1616TZ	0	1,832.00	274
18 X 18	XDMJX1818TZ	0	POA	305
20 X 20	XDMJX2020TZ	0	3,345.00	352
24 X 24	XDMJX2424TZ	0	POA	496

## TEES : MJ X FE

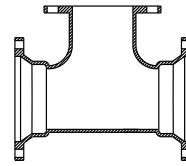

Size (in)	Item No.	Crt. Qty.	List Price \$	Wt. (lb.)
3 X 3	XDMJFT0303Z		POA	45
4 X 2	XDMJFT0402Z		534.00	53
4 X 4	XDMJFT0404Z		555.00	74
6 X 3	XDMJFT0603Z		POA	115
6 X 4	XDMJFT0604Z		804.00	109
6 X 6	XDMJFT0606Z	2	868.00	120
8 X 4	XDMJFT0804Z		1,102.00	159
8 X 6	XDMJFT0806Z	2	984.00	170
8 X 8	XDMJFT0808Z	2	1,193.00	194
10 X 4	XDMJFT1004Z		1,424.00	229
10 X 6	XDMJFT1006Z	12	1,394.00	245
10 X 8	XDMJFT1008Z		1,544.00	250
12 X 4	XDMJFT1204Z	2	1,987.00	323
12 X 6	XDMJFT1206Z	2	1,922.00	320
12 X 8	XDMJFT1208Z	2	2,765.00	342
12 X 10	XDMJFT1210Z		POA	372
12 X 12	XDMJFT1212Z		POA	401
14 X 6	XDMJFT1406Z		POA	457
14 X 8	XDMJFT1408Z		POA	473
16 X 4	XDMJFT1604Z		3,784.00	575
16 X 6	XDMJFT1606Z		3,982.00	605
16 X 8	XDMJFT1608Z		4,048.00	615
16 X 12	XDMJFT1612Z		4,285.00	651
16 X 16	XDMJFT1616Z		4,802.00	730
18 X 6	XDMJFT1806Z		4,375.00	665
18 X 8	XDMJFT1808Z		4,442.00	675
18 X 12	XDMJFT1812Z		4,639.00	735
18 X 18	XDMJFT1818Z		6,019.00	915
20 X 6	XDMJFT2006Z		POA	820
20 X 8	XDMJFT2008Z		5,494.00	835
20 X 12	XDMJFT2012Z		POA	700
20 X 20	XDMJFT2020Z		7,663.00	1165
24 X 6	XDMJFT2406Z		7,402.00	1125
24 X 8	XDMJFT2408Z		7,496.00	1140
24 X 12	XDMJFT2412Z		7,663.00	1165
24 X 18	XDMJFT2418Z		POA	1349
24 X 24	XDMJFT2424Z		11,806.00	1795
30 X 6	XDMJFT3006Z		POA	1800

Size (in)	Item No.	Crt. Qty.	List Price \$	Wt. (lb.)
30 X 8	XDMJFT3008Z		POA	1725
30 X 30	XDMJFT3030Z		POA	3080
36 X 6	XDMJFT3606Z		17,335.00	2430
36 X 8	XDMJFT3608Z		POA	
36 X 12	XDMJFT3612Z		17,764.00	2550
36 X 16	XDMJFT3616Z		17,706.00	2450
36 X 24	XDMJFT3624Z		24,374.00	2660
36 X 30	XDMJFT3630Z		34,632.00	2964
36 X 36	XDMJFT3636Z		36,750.00	3461
42 X 12	XDMJFT4212Z		39,104.00	3547
42 X 16	XDMJFT4216Z		40,785.00	3562
42 X 24	XDMJFT4224Z		42,417.00	3527
48 X 24	XDMJFT4824Z		POA	4965

## CROSSES : MJ X FE

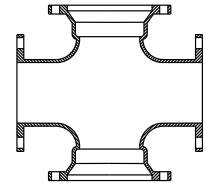

Size (in)	Item No.	Crt. Qty.	List Price (\$)	Wt. (lb.)
6 X 6	XDMJFX0606Z	0	POA	140
8 X 6	XDMJFX0806Z	0	POA	185
8 X 8	XDMJFX0808Z	0	POA	240
10 X 10	XDMJFX1010Z	0	POA	354
12 X 6	XDMJFX1206Z	0	POA	340
12 X 8	XDMJFX1208Z	0	POA	365
12 X 12	XDMJFX1212Z	0	POA	487
16 X 8	XDMJFX1608Z	0	POA	655
16 X 16	XDMJFX1616Z	0	POA	875

ZINC ZINC ZINC ZINC ZINC

ZINC ZINC ZINC ZINC ZINC ZINC ZINC ZINC ZINC ZINC ZINC

**CROSSES : MJ X MJ**

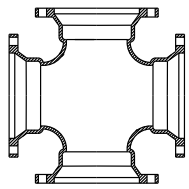

Size (in)	Item No.	Crt. Qty.	List Price (\$)	Wt. (lb.)
4 X 4	XDMJX0404Z		654.00	105
6 X 4	XDMJX0604Z		POA	142
6 X 6	XDMJX0606Z	8	954.00	160
8 X 4	XDMJX0804Z		1,149.00	185
8 X 6	XDMJX0806Z		1,273.00	205
8 X 8	XDMJX0808Z	4	1,403.00	235
10 X 6	XDMJX1006Z		1,767.00	285
10 X 8	XDMJX1008Z		1,920.00	310
10 X 10	XDMJX1010Z		2,353.00	380
12 X 4	XDMJX1204Z		2,540.00	340
12 X 6	XDMJX1206Z		2,229.00	360
12 X 8	XDMJX1208Z	2	2,354.00	385
12 X 12	XDMJX1212Z	2	3,025.00	495
14 X 8	XDMJX1408Z		2,960.00	500
14 X 14	XDMJX1414Z		4,178.00	635
16 X 6	XDMJX1606Z		3,784.00	575
16 X 8	XDMJX1608Z		3,982.00	605
16 X 12	XDMJX1612Z		7,283.00	685
16 X 16	XDMJX1616Z		5,196.00	790
18 X 8	XDMJX1808Z		4,185.00	655
18 X 10	XDMJX1810Z		4,507.00	685
18 X 12	XDMJX1812Z		4,770.00	725
18 X 18	XDMJX1818Z		6,546.00	995
20 X 8	XDMJX2008Z		5,132.00	790
20 X 12	XDMJX2012Z		5,658.00	860
20 X 16	XDMJX2016Z		7,138.00	1085
20 X 20	XDMJX2020Z		8,089.00	1230
24 X 6	XDMJX2406Z		6,664.00	1025
24 X 8	XDMJX2408Z		6,874.00	1045
24 X 12	XDMJX2412Z		7,295.00	1110
24 X 16	XDMJX2416Z		7,896.00	1200
24 X 20	XDMJX2420Z		11,017.00	1675
24 X 24	XDMJX2424Z		12,069.00	1835
30 X 6	XDMJX3006Z		12,330.00	1770
30 X 12	XDMJX3012Z		12,993.00	1865
30 X 16	XDMJX3016Z		22,607.00	1968
30 X 24	XDMJX3024Z		18,634.00	2675
30 X 30	XDMJX3030Z		21,420.00	3075
36 X 12	XDMJX3612Z		18,319.00	2645

Size (in)	Item No.	Crt. Qty.	List Price (\$)	Wt. (lb.)
36 X 16	XDMJX3616Z		29,490.00	2718
36 X 20	XDMJX3620Z		30,116.00	2815
36 X 24	XDMJX3624Z		27,634.00	2910
36 X 30	XDMJX3630Z		37,643.00	3978
36 X 36	XDMJX3636Z		30,439.00	4370
42 X 24	XDMJX4224Z		68,929.00	3924
42 X 30	XDMJX4230Z		87,149.00	5039
42 X 36	XDMJX4236Z		1,05,960.00	5428
42 X 42	XDMJX4242Z		1,14,524.00	7145
48 X 24	XDMJX4824Z		47,502.00	5225
48 X 30	XDMJX4830Z		50,010.00	5510
48 X 36	XDMJX4836Z		49,939.00	6795
48 X 42	XDMJX4842Z		71,413.00	8827
48 X 48	XDMJX4848Z		89,718.00	9400

**MJ 45° LATERAL (WYES)**

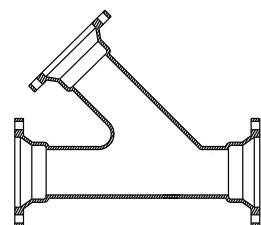

Size (in)	Item No.	Crt. Qty.	List Price (\$)	Wt. (lb.)
3 X 3	XDMJL0303Z		373.00	60
4 X 3	XDMJL0403Z		POA	
4 X 4	XDMJL0404Z		559.00	90
6 X 4	XDMJL0604Z	12	838.00	130
6 X 6	XDMJL0606Z	4	1,045.00	145
8 X 4	XDMJL0804Z		1,179.00	190
8 X 6	XDMJL0806Z	4	1,273.00	205
8 X 8	XDMJL0808Z	4	1,306.00	230
10 X 4	XDMJL1004Z		2,746.00	274
10 X 6	XDMJL1006Z		1,767.00	285
10 X 8	XDMJL1008Z		1,892.00	310
10 X 10	XDMJL1010Z		2,323.00	340
12 X 4	XDMJL1204Z		2,577.00	382
12 X 6	XDMJL1206Z		2,955.00	396
12 X 8	XDMJL1208Z		2,632.00	425

Contd.....

**MJ 45° LATERAL (WYES)** Contd.....

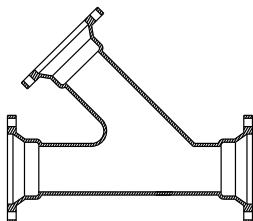

Size (in)	Item No.	Crt. Qty.	List Price (\$)	Wt. (lb.)
12 X 10	XDMJL1210Z		3,789.00	512
12 X 12	XDMJL1212Z		3,312.00	535
14 X 6	XDMJL1406Z		3,719.00	615
14 X 8	XDMJL1408Z		4,185.00	630
14 X 12	XDMJL1412Z		5,852.00	652
14 X 14	XDMJL1414Z		4,969.00	725
16 X 6	XDMJL1606Z		5,066.00	770
16 X 8	XDMJL1608Z		5,230.00	795
16 X 10	XDMJL1610Z		5,460.00	835
16 X 12	XDMJL1612Z		5,723.00	872
16 X 16	XDMJL1616Z		5,854.00	1079
18 X 6	XDMJL1806Z		POA	752
18 X 8	XDMJL1808Z		6,267.00	968
18 X 10	XDMJL1810Z		7,038.00	975
18 X 12	XDMJL1812Z		7,433.00	1015
18 X 16	XDMJL1816Z		7,563.00	1135
18 X 18	XDMJL1818Z		7,892.00	1200
20 X 06	XDMJL2006Z		POA	872
20 X 08	XDMJL2008Z		POA	689
20 X 10	XDMJL2010Z		8,239.00	1220
20 X 12	XDMJL2012Z		7,905.00	1260
20 X 14	XDMJL2014Z		13,163.00	1368
20 X 16	XDMJL2016Z		7,683.00	1375
20 X 20	XDMJL2020Z		10,032.00	1525
24 X 6	XDMJL2406Z		POA	1874
24 X 8	XDMJL2408Z		POA	1882
24 X 12	XDMJL2412Z		19,582.00	1388
24 X 16	XDMJL2416Z		21,227.00	1827
24 X 18	XDMJL2418Z		22,586.00	2075
24 X 20	XDMJL2420Z		19,090.00	2148
24 X 24	XDMJL2424Z		14,764.00	2372
30 X 12	XDMJL3012Z		30,819.00	3125
30 X 16	XDMJL3016Z		26,582.00	3264
30 X 18	XDMJL3018Z		27,032.00	2995
30 X 20	XDMJL3020Z		24,459.00	3418
30 X 24	XDMJL3024Z		25,729.00	3292
30 X 30	XDMJL3030Z		25,565.00	3670
36 X 12	XDMJL3612Z		43,156.00	4695
36 X 16	XDMJL3616Z		39,263.00	5050

Size (in)	Item No.	Crt. Qty.	List Price (\$)	Wt. (lb.)
36 X 18	XDMJL3618Z		41,630.00	5025
36 X 20	XDMJL3620Z		36,627.00	5090
36 X 24	XDMJL3624Z		36,696.00	5851
36 X 30	XDMJL3630Z		40,397.00	5815
36 X 36	XDMJL3636Z		48,583.00	6900
42 X 24	XDMJL4224Z		50,085.00	6810
42 X 30	XDMJL4230Z		53,027.00	7280
42 X 36	XDMJL4236Z		61,449.00	8355
42 X 42	XDMJL4242Z		77,722.00	9915
48 X 20	XDMJL4820Z		72,475.00	6554
48 X 24	XDMJL4824Z		POA	
48 X 30	XDMJL4830Z		76,038.00	6574
48 X 48	XDMJL4848Z		82,982.00	11892

**MJ X PE OFFSET**

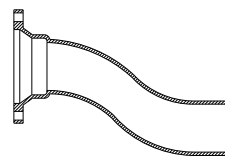

Size (in)	Item No.	Crt. Qty.	List Price (\$)	Wt. (lb.)
4 X 6	XDMJOP0406Z		704.00	70
4 X 12	XDMJOP0412Z		718.00	80
4 X 24	XDMJOP0424Z		967.00	125
6 X 6	XDMJOP0606Z		868.00	105
6 X 12	XDMJOP0612Z		807.00	130
6 X 18	XDMJOP0618Z		947.00	160
6 X 24	XDMJOP0624Z		937.00	160
8 X 6	XDMJOP0806Z		1,575.00	155
8 X 12	XDMJOP0812Z		1,284.00	195
8 X 18	XDMJOP0818Z		2,378.00	240
8 X 24	XDMJOP0824Z		1,844.00	285
10 X 12	XDMJOP1012Z		POA	280
10 X 18	XDMJOP1018Z		POA	340
12 X 06	XDMJOP1206Z		2,657.00	328
12 X 12	XDMJOP1212Z		4,457.00	420
12 X 18	XDMJOP1218Z	2	POA	520
12 X 24	XDMJOP1224Z		POA	630
16 X 18	XDMJOP1618Z		POA	690

ZINC ZINC ZINC ZINC ZINC ZINC ZINC ZINC ZINC ZINC ZINC ZINC

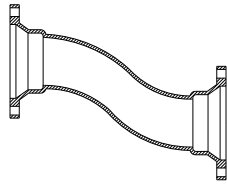
**MJ OFFSET**

Size (in)	Item No.	Crt. Qty.	List Price (\$)	Wt. (lb.)
4 X 6	XDMJO0406Z	0	POA	75
4 X 12	XDMJO0412Z	0	532.00	85
4 X 18	XDMJO0418Z	0	654.00	105
4 X 24	XDMJO0424Z	0	777.00	126
6 X 6	XDMJO0606Z	0	683.00	114
6 X 12	XDMJO0612Z	0	838.00	135
6 X 18	XDMJO0618Z	0	1,025.00	188
6 X 24	XDMJO0624Z	0	960.00	182
8 X 6	XDMJO0806Z	0	992.00	177
8 X 12	XDMJO0812Z	0	1,238.00	231
8 X 18	XDMJO0818Z	0	1,513.00	287
8 X 24	XDMJO0824Z	0	1,584.00	280
10 X 12	XDMJO1012Z	0	2,072.00	347
10 X 18	XDMJO1018Z	0	2,105.00	340
10 X 24	XDMJO1024Z	0	2,599.00	420
12 X 6	XDMJO1206Z	0	POA	345
12 X 12	XDMJO1212Z	0	2,599.00	420
12 X 18	XDMJO1218Z	0	3,219.00	520
12 X 24	XDMJO1224Z	0	3,962.00	649
16 X 12	XDMJO1612Z	0	4,258.00	715
16 X 18	XDMJO1618Z	0	4,570.00	850
20 X 12	XDMJO2012Z	0	4,770.00	1025
20 X 18	XDMJO2018Z	0	7,826.00	1246
20 X 24	XDMJO2024Z	0	POA	1362

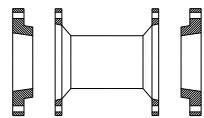
**MJ DUAL PURPOSE SLEEVES**

Size (in)	Item No.	Crt. Qty.	List Price (\$)	Wt. (lb.)
4	XDMJSSDP04Z	24	POA	35
6	XDMJSSDP06Z	18	POA	45
8	XDMJSSDP08Z	0	POA	65

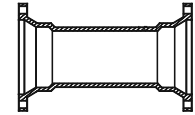
**MJ LONG SLEEVES**

Size (in)	Item No.	Crt. Qty.	List Price \$	Wt. (lb.)
2	XDMJSL02Z	0	190.00	18
3	XDMJSL03Z	0	189.00	30
4	XDMJSL04Z	24	242.00	45
6	XDMJSL06Z	27	350.00	65
8	XDMJSL08Z	27	442.00	85
10	XDMJSL10Z	12	718.00	115
12	XDMJSL12Z	12	832.00	145
14	XDMJSL14Z	2	1,285.00	195
16	XDMJSL16Z	2	1,525.00	235
18	XDMJSL18Z	0	2,079.00	285
20	XDMJSL20Z	2	2,113.00	325
24	XDMJSL24Z	0	2,777.00	425
30	XDMJSL30Z	0	6,433.00	1088
36	XDMJSL36Z	0	8,688.00	1052
42	XDMJSL42Z	0	9,709.00	1550
48	XDMJSL48Z	0	15,468.00	1940

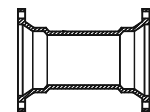
**MJ SHORT SLEEVES**

Size (in)	Item No.	Crt. Qty.	List Price (\$)	Wt. (lb.)
2	XDMJSS02Z	48	110.00	12
3	XDMJSS03Z		POA	25
4	XDMJSS04Z	4	213.00	35
6	XDMJSS06Z	4	244.00	45
8	XDMJSS08Z	27	350.00	65
10	XDMJSS10Z	4	516.00	85
12	XDMJSS12Z	12	674.00	110
14	XDMJSS14Z		1,504.00	150
16	XDMJSS16Z		1,147.00	180
18	XDMJSS18Z		1,417.00	215
20	XDMJSS20Z		1,580.00	240
24	XDMJSS24Z		2,440.00	320
30	XDMJSS30Z		5,255.00	635
36	XDMJSS36Z		7,174.00	855
42	XDMJSS42Z		8,203.00	1115
48	XDMJSS48Z		12,325.00	1385

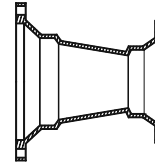
**REDUCERS : MJ X MJ**

Size (in)	Item No.	Crt. Qty.	List Price (\$)	Wt. (lb.)
3 X 2	XDMJR0302Z	60	187.00	26
4 X 2	XDMJR0402Z	48	196.00	30
4 X 3	XDMJR0403Z	48	240.00	40
6 X 2	XDMJR0602Z	24	286.00	45
6 X 3	XDMJR0603Z	24	332.00	55
6 X 4	XDMJR0604Z	24	322.00	60
8 X 3	XDMJR0803Z		578.00	84
8 X 4	XDMJR0804Z	16	516.00	80
8 X 6	XDMJR0806Z	16	508.00	95
10 X 4	XDMJR1004Z		872.00	105
10 X 6	XDMJR1006Z	12	697.00	115
10 X 8	XDMJR1008Z	12	818.00	135
12 X 4	XDMJR1204Z	8	884.00	135
12 X 6	XDMJR1206Z	8	1,086.00	150
12 X 8	XDMJR1208Z	8	1,022.00	165
12 X 10	XDMJR1210Z	8	1,155.00	190
14 X 6	XDMJR1406Z	4	1,139.00	190
14 X 8	XDMJR1408Z		1,384.00	214
14 X 10	XDMJR1410Z		1,514.00	236
14 X 12	XDMJR1412Z	2	1,683.00	255
16 X 6	XDMJR1606Z		1,514.00	230
16 X 8	XDMJR1608Z		2,017.00	250
16 X 10	XDMJR1610Z		1,835.00	280
16 X 12	XDMJR1612Z		2,203.00	305
16 X 14	XDMJR1614Z		2,206.00	335
18 X 8	XDMJR1808Z		1,943.00	295
18 X 10	XDMJR1810Z		2,142.00	325
18 X 12	XDMJR1812Z		2,303.00	350
18 X 14	XDMJR1814Z		2,502.00	380
18 X 16	XDMJR1816Z		2,733.00	415
20 X 8	XDMJR2008Z		POA	345
20 X 10	XDMJR2010Z		2,440.00	375
20 X 12	XDMJR2012Z		2,667.00	405
20 X 14	XDMJR2014Z		3,852.00	435
20 X 16	XDMJR2016Z		3,093.00	470
20 X 18	XDMJR2018Z		3,356.00	510
24 X 12	XDMJR2412Z		3,618.00	550
24 X 16	XDMJR2416Z		4,048.00	615
24 X 18	XDMJR2418Z		4,342.00	660

Size (in)	Item No.	Crt. Qty.	List Price (\$)	Wt. (lb.)
24 X 20	XDMJR2420Z		4,639.00	705
30 X 12	XDMJR3012Z		7,046.00	920
30 X 16	XDMJR3016Z		6,864.00	985
30 X 18	XDMJR3018Z		6,898.00	990
30 X 20	XDMJR3020Z		7,317.00	1050
30 X 24	XDMJR3024Z		8,118.00	1165
36 X 20	XDMJR3620Z		10,103.00	1450
36 X 24	XDMJR3624Z		11,006.00	1580
36 X 30	XDMJR3630Z		12,924.00	1855
42 X 20	XDMJR4220Z		14,087.00	1928
42 X 24	XDMJR4224Z		15,150.00	2060
42 X 30	XDMJR4230Z		17,432.00	2370
42 X 36	XDMJR4236Z		19,824.00	2714
48 X 30	XDMJR4830Z		22,103.00	3005
48 X 36	XDMJR4836Z		24,787.00	3385
48 X 42	XDMJR4842Z		27,580.00	3776

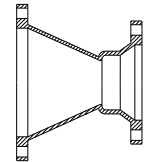
**REDUCERS : FE X MJ**

Size (in)	Item No.	Crt. Qty.	List Price (\$)	Wt. (lb.)
4 X 3	FXDMJR0403Z	0	209.00	34
6 X 4	FXDMJR0604Z	0	316.00	60
8 X 4	FXDMJR0804Z	0	430.00	80
8 X 6	FXDMJR0806Z	0	520.00	89
10 X 6	FXDMJR1006Z	0	682.00	114
10 X 8	FXDMJR1008Z	0	753.00	130
12 X 6	FXDMJR1206Z	0	845.00	151
12 X 8	FXDMJR1208Z	0	996.00	183
12 X 10	FXDMJR1210Z	0	1,087.00	190
16 X 12	FXDMJR1612Z	0	1,844.00	305

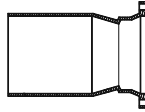
**REDUCERS : MJ  
SMALL END (SEB)**

Size (in)	Item No.	Crt. Qty.	List Price (\$)	Wt. (lb.)
3 X 2	XDMJRS0302Z	48	258.00	14
4 X 2	XDMJRS0402Z	48	222.00	18
4 X 3	XDMJRS0403Z		218.00	35
6 X 2	XDMJRS0602Z	26	300.00	45
6 X 3	XDMJRS0603Z		312.00	50
6 X 4	XDMJRS0604Z		373.00	60
8 X 3	XDMJRS0803Z		475.00	77
8 X 4	XDMJRS0804Z	16	497.00	80
8 X 6	XDMJRS0806Z	16	559.00	90
10 X 6	XDMJRS1006Z		714.00	115
10 X 8	XDMJRS1008Z		807.00	130
12 X 4	XDMJRS1204Z		807.00	130
12 X 6	XDMJRS1206Z		930.00	150
12 X 8	XDMJRS1208Z	12	1,025.00	165
12 X 10	XDMJRS1210Z		1,179.00	190
16 X 8	XDMJRS1608Z		1,514.00	230
16 X 12	XDMJRS1612Z		1,877.00	285
16 X 14	XDMJRS1614Z		3,439.00	310
18 X 12	XDMJRS1812Z		2,142.00	325
20 X 8	XDMJRS2008Z		POA	345
20 X 12	XDMJRS2012Z		2,470.00	375
20 X 16	XDMJRS2016Z		2,863.00	435
20 X 18	XDMJRS2018Z		4,286.00	345
24 X 12	XDMJRS2412Z		3,356.00	510
24 X 14	XDMJRS2414Z		5,486.00	535
24 X 16	XDMJRS2416Z		3,784.00	575
24 X 18	XDMJRS2418Z		4,079.00	620
24 X 20	XDMJRS2420Z		4,375.00	665
30 X 16	XDMJRS3016Z		6,269.00	900
30 X 18	XDMJRS3018Z		6,167.00	885
30 X 20	XDMJRS3020Z		6,585.00	945
30 X 24	XDMJRS3024Z		7,384.00	1060
36 X 20	XDMJRS3620Z		14,465.00	1285
36 X 24	XDMJRS3624Z		16,342.00	1410
36 X 30	XDMJRS3630Z		11,774.00	1690
42 X 30	XDMJRS4230Z		22,672.00	2165
42 X 36	XDMJRS4236Z		24,408.00	2485
48 X 36	XDMJRS4836Z		22,799.00	3100

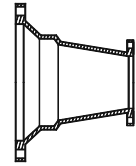
**REDUCERS : MJ X FE**

Size (in)	Item No.	Crt. Qty.	List Price (\$)	Wt. (lb.)
4 X 3	XDMJFR0403Z	0	215.00	35
6 X 3	XDMJFR0603Z	0	326.00	49
6 X 4	XDMJFR0604Z	0	343.00	54
8 X 4	XDMJFR0804Z	0	463.00	75
8 X 6	XDMJFR0806Z	2	504.00	80
10 X 6	XDMJFR1006Z	0	584.00	105
10 X 8	XDMJFR1008Z	0	753.00	130
12 X 6	XDMJFR1206Z	0	770.00	145
12 X 8	XDMJFR1208Z	0	1,082.00	175
12 X 10	XDMJFR1210Z	0	1,070.00	185
14 X 6	XDMJFR1406Z	0	1,178.00	195
14 X 8	XDMJFR1408Z	0	1,420.00	215
14 X 12	XDMJFR1412Z	0	1,482.00	270
16 X 12	XDMJFR1612Z	0	2,233.00	325
18 X 8	XDMJFR1808Z	0	1,975.00	300
18 X 12	XDMJFR1812Z	0	2,616.00	360
18 X 16	XDMJFR1816Z	0	2,929.00	445
20 X 16	XDMJFR2016Z	0	3,356.00	510
24 X 12	XDMJFR2412Z	0	4,353.00	455

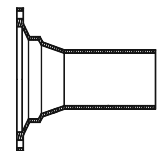
**REDUCERS : MJ  
LARGE END (LEB)**

Size (in)	Item No.	Crt. Qty.	List Price (\$)	Wt. (lb.)
4 X 3	XDMJRL0403Z		248.00	40
6 X 3	XDMJRL0603Z		343.00	55
6 X 4	XDMJRL0604Z		373.00	60
8 X 3	XDMJRL0803Z		466.00	70
8 X 4	XDMJRL0804Z		497.00	80
8 X 6	XDMJRL0806Z		610.00	98
10 X 6	XDMJRL1006Z		714.00	115
10 X 8	XDMJRL1008Z		807.00	130
12 X 4	XDMJRL1204Z		POA	135
12 X 6	XDMJRL1206Z		900.00	145
12 X 8	XDMJRL1208Z		1,025.00	165
12 X 10	XDMJRL1210Z		1,149.00	185

Contd.....





**MJ CAPS : SOLID**

Size (in)	Item No.	Crt. Qty.	List Price (\$)	Wt. (lb.)
2	XDMJC02Z	100	58.00	5
3	XDMJC03Z	50	75.00	12
4	XDMJC04Z	18	93.00	20
6	XDMJC06Z	18	138.00	30
8	XDMJC08Z	18	237.00	45
10	XDMJC10Z	8	365.00	60
12	XDMJC12Z	8	490.00	80
14	XDMJC14Z	2	936.00	110
16	XDMJC16Z	2	988.00	155
18	XDMJC18Z	2	1,140.00	185
20	XDMJC20Z	2	1,562.00	200
24	XDMJC24Z	2	2,272.00	300
30	XDMJC30Z	0	4,113.00	590
36	XDMJC36Z	0	5,924.00	815
42	XDMJC42Z	0	8,679.00	1180
48	XDMJC48Z	0	11,733.00	1595

**MJ CAPS : 2" TAPPED**

Size (in)	Item No.	Crt. Qty.	List Price (\$)	Wt. (lb.)
2	XDMJC02TZ	0	97.00	5
3	XDMJC03TZ	0	114.00	12
4	XDMJC04TZ	0	125.00	20
6	XDMJC06TZ	18	182.00	30
8	XDMJC08TZ	18	283.00	45
10	XDMJC10TZ	0	403.00	60
12	XDMJC12TZ	8	529.00	80
14	XDMJC14TZ	0	998.00	110
16	XDMJC16TZ	0	1,057.00	155
18	XDMJC18TZ	0	1,150.00	185
20	XDMJC20TZ	0	1,512.00	200
24	XDMJC24TZ	0	2,149.00	300
30	XDMJC30TZ	0	4,228.00	590
36	XDMJC36TZ	0	POA	815
42	XDMJC42TZ	0	POA	1180
48	XDMJC48TZ	0	POA	1595

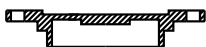
**MJ PLUGS : SOLID**

Size (in)	Item No.	Crt. Qty.	List Price (\$)	Wt. (lb.)
2	XDMJP02Z	24	56.00	5
3	XDMJP03Z	0	63.00	10
4	XDMJP04Z	18	93.00	20
6	XDMJP06Z	18	152.00	30
8	XDMJP08Z	12	272.00	50
10	XDMJP10Z	8	396.00	65
12	XDMJP12Z	8	522.00	85
14	XDMJP14Z	0	760.00	115
16	XDMJP16Z	2	949.00	145
18	XDMJP18Z	0	895.00	180
20	XDMJP20Z	0	1,562.00	200
24	XDMJP24Z	0	2,267.00	290
30	XDMJP30Z	0	4,008.00	575
36	XDMJP36Z	0	5,679.00	815
42	XDMJP42Z	0	8,166.00	1110
48	XDMJP48Z	0	10,703.00	1455

**MJ PLUGS : 2" TAPPED**

Size (in)	Item No.	Crt. Qty.	List Price \$	Wt. (lb.)
3	XDMJP03TE	0	100.00	10
4	XDMJP04TE	18	125.00	20
6	XDMJP06TE	120	182.00	30
8	XDMJP08TE	100	288.00	50
10	XDMJP10TE	8	402.00	65
12	XDMJP12TE	40	517.00	85
14	XDMJP14TE	0	823.00	115
16	XDMJP16TE	0	1,002.00	145
18	XDMJP18TE	0	867.00	180
20	XDMJP20TE	0	1,523.00	200
24	XDMJP24TE	0	2,285.00	290
30	XDMJP30TE	0	3,878.00	575
36	XDMJP36TE	0	POA	815
42	XDMJP42TE	0	POA	1110
48	XDMJP48TE	0	POA	1455

# Utility Pipe Fittings Zinc Coated

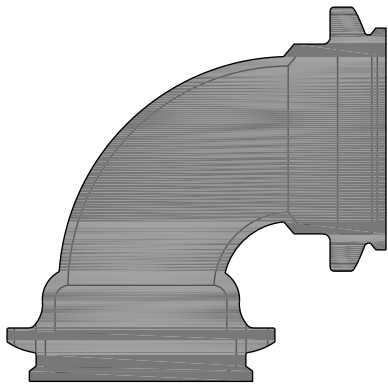

ANSI/AWWA C153/A21.53  
**COMPACT PUSH-ON FITTINGS**  

---

**ZINC COATED**

**PRICE LIST**  
Effective January 14, 2019.

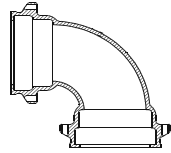

**BENDS : PO X PO  
90° (1/4)**

Size (in)	Item No.	Crt. Qty.	List Price (\$)	Wt. (lb.)
4	CDPOB9004Z	60	210.00	28
6	CDPOB9006Z	32	334.00	44
8	CDPOB9008Z	18	495.00	71
10	CDPOB9010Z	12	650.00	100
12	CDPOB9012Z	6	1,074.00	140
14	CDPOB9014Z	0	1,562.00	254
16	CDPOB9016Z	4	2,793.00	280
18	CDPOB9018Z	0	3,663.00	482
20	CDPOB9020Z	0	4,100.00	640
24	CDPOB9024Z	2	5,118.00	710

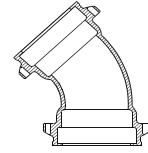
**BENDS : PO X PO  
45° (1/8)**

Size (in)	Item No.	Crt. Qty.	List Price (\$)	Wt. (lb.)
4	CDPOB4504Z	75	190.00	23
6	CDPOB4506Z	36	283.00	38
8	CDPOB4508Z	27	414.00	54
10	CDPOB4510Z	18	620.00	84
12	CDPOB4512Z	8	827.00	110
14	CDPOB4514Z		1,238.00	150
16	CDPOB4516Z	4	1,954.00	210
18	CDPOB4518Z		2,134.00	309
20	CDPOB4520Z		3,015.00	397
24	CDPOB4524Z		3,737.00	455

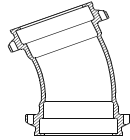
**BENDS : PO X PO  
22½° (1/16)**

Size (in)	Item No.	Crt. Qty.	List Price (\$)	Wt. (lb.)
4	CDPOB2204Z	75	182.00	22
6	CDPOB2206Z	48	252.00	34
8	CDPOB2208Z	27	352.00	55
10	CDPOB2210Z	18	525.00	70
12	CDPOB2212Z	8	703.00	90
14	CDPOB2214Z		1,238.00	162
16	CDPOB2216Z	4	1,819.00	220
18	CDPOB2218Z		2,329.00	209
20	CDPOB2220Z		3,146.00	414
24	CDPOB2224Z		4,290.00	455

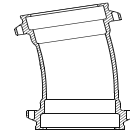
**BENDS : PO X PO  
11¼° (1/32)**

Size (in)	Item No.	Crt. Qty.	List Price (\$)	Wt. (lb.)
4	CDPOB1104Z	75	179.00	21
6	CDPOB1106Z	48	247.00	32
8	CDPOB1108Z	25	345.00	52
10	CDPOB1110Z	18	510.00	70
12	CDPOB1112Z	8	680.00	95
14	CDPOB1114Z		1,238.00	113
16	CDPOB1116Z	4	1,842.00	170
18	CDPOB1118Z		2,343.00	209
20	CDPOB1120Z		2,854.00	265
24	CDPOB1124Z	2	5,677.00	315

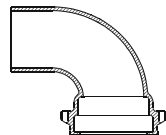
**BENDS : PO X PE  
90° (1/4)**

Size (in)	Item No.	Crt. Qty.	List Price (\$)	Wt. (lb.)
4	CDPOPB9004Z	60	382.00	24
6	CDPOPB9006Z	32	362.00	48
8	CDPOPB9008Z		POA	

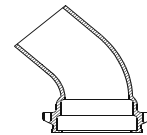
**BENDS : PO X PE  
45° (1/8)**

Size (in)	Item No.	Crt. Qty.	List Price (\$)	Wt. (lb.)
4	CDPOPB4504Z	75	138.00	21
6	CDPOPB4506Z	36	293.00	38
8	CDPOPB4508Z	27	458.00	60











## PO CAPS TAPPED

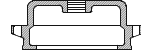

Size (in)	Item No.	Crt. Qty.	List Price (\$)	Wt. (lb.)
4	CDPOCT04Z	120	132.00	13
6	CDPOCT06Z	72	179.00	20
8	CDPOCT08Z	54	255.00	32
10	CDPOCT10Z	36	324.00	40
12	CDPOCT12Z	24	439.00	63
14	CDPOCT14Z		POA	70
16	CDPOCT16Z	12	POA	110
18	CDPOCT18Z		POA	120
20	CDPOCT20Z		POA	150
24	CDPOCT24Z		POA	216

## PO PLUGS SOLID

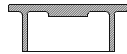

Size (in)	Item No.	Crt. Qty.	List Price (\$)	Wt. (lb.)
4	CDPOP04Z	200	70.00	12
6	CDPOP06Z	96	120.00	18
8	CDPOP08Z	72	164.00	29
10	CDPOP10Z	36	246.00	35
12	CDPOP12Z	30	284.00	46
14	CDPOP14Z		POA	74
16	CDPOP16Z	20	POA	60
18	CDPOP18Z		POA	120
20	CDPOP20Z		POA	145
24	CDPOP24Z	4	POA	204

## PO PLUGS TAPPED

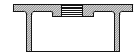

Size (in)	Item No.	Crt. Qty.	List Price (\$)	Wt. (lb.)
4	CDPOPT04Z	100	94.00	12
6	CDPOPT06Z	72	160.00	18
8	CDPOPT08Z	54	203.00	29
10	CDPOPT10Z	36	286.00	35
12	CDPOPT12Z	24	322.00	46
14	CDPOPT14Z		POA	74
16	CDPOPT16Z	8	POA	60
18	CDPOPT18Z		POA	120
20	CDPOPT20Z		POA	145
24	CDPOPT24Z	4	POA	204

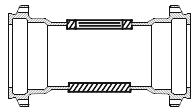
**TEES : PO TAPPED 2"**

Size (in)	Item No.	Crt. Qty.	List Price (\$)	Wt. (lb.)
4	CDCDPOTT04Z		244.00	27
6	CDCDPOTT06Z		325.00	38
8	CDCDPOTT08Z		482.00	59
10	CDCDPOTT10Z		575.00	72
12	CDCDPOTT12Z		732.00	92

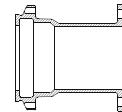
**PO FLANGE ADAPTER**

Size (in)	Item No.	Crt. Qty.	List Price (\$)	Wt. (lb.)
4	CDPOFA04Z	80	186.00	22
6	CDPOFA06Z	48	285.00	34
8	CDPOFA08Z	36	394.00	50
10	CDPOFA10Z	24	496.00	70
12	CDPOFA12Z	16	757.00	80
14	CDPOFA14Z		1,315.00	113
16	CDPOFA16Z	8	1,493.00	180
18	CDPOFA18Z		2,033.00	226
20	CDPOFA20Z		2,243.00	264
24	CDPOFA24Z	4	4,094.00	308

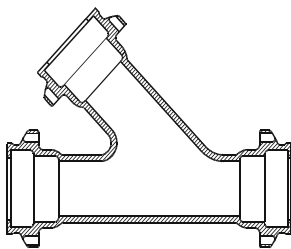
**PO LATERAL WYES**

Size (in)	Item No.	Crt. Qty.	List Price (\$)	Wt. (lb.)
4 X 4	CDPOL0404Z	8	POA	55
6 X 4	CDPOL0604Z	8	POA	75
6 X 6	CDPOL0606Z	8	POA	83
8 X 4	CDPOL0804Z		764.00	90
8 X 6	CDPOL0806Z	8	POA	125
8 X 8	CDPOL0808Z	8	POA	140
10X 4	CDPOL1004Z		910.00	141
10X 6	CDPOL1006Z		1,154.00	155
10X 8	CDPOL1008Z		1,499.00	160
10X10	CDPOL1010Z	4	1,395.00	170
12X 4	CDPOL1204Z		1,445.00	178
12X 6	CDPOL1206Z		1,529.00	234
12X 8	CDPOL1208Z		1,678.00	260
12X10	CDPOL1210Z		1,839.00	280
12X12	CDPOL1212Z	3	1,850.00	300
14X 6	CDPOL1406Z		1,794.00	236
14X 8	CDPOL1408Z		1,938.00	255
14X10	CDPOL1410Z		2,470.00	325
14X14	CDPOL1414Z		3,607.00	475
16X 6	CDPOL1606Z		2,136.00	281
16X 8	CDPOL1608Z		2,310.00	304
16X12	CDPOL1612Z		2,628.00	346
16X16	CDPOL1616Z		2,886.00	380

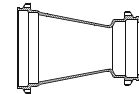
**REDUCERS : PO X PO**

Size (in)	Item No.	Crt. Qty.	List Price (\$)	Wt. (lb.)
6 X 4	CDPOR0604Z	60	209.00	30
8 X 4	CDPOR0804Z	36	296.00	40
8 X 6	CDPOR0806Z	36	305.00	40
10X 4	CDPOR1004Z		565.00	55
10X 6	CDPOR1006Z		440.00	60
10X 8	CDPOR1008Z	18	487.00	65
12X 4	CDPOR1204Z	12	620.00	70
12X 6	CDPOR1206Z	18	523.00	75
12X 8	CDPOR1208Z	12	566.00	80
12X10	CDPOR1210Z	12	679.00	107
14X 6	CDPOR1406Z		570.00	84
14X 8	CDPOR1408Z		577.00	85
14X10	CDPOR1410Z		592.00	87
14X12	CDPOR1412Z		705.00	104
16X 6	CDPOR1606Z	4	1,200.00	138
16X 8	CDPOR1608Z	4	1,244.00	137
16X10	CDPOR1610Z	4	1,216.00	130
16X12	CDPOR1612Z	4	1,283.00	135
16X14	CDPOR1614Z		1,058.00	139
18X 8	CDPOR1808Z		1,082.00	142
18X10	CDPOR1810Z		1,148.00	151
18X12	CDPOR1812Z		1,273.00	167
18X14	CDPOR1814Z		1,652.00	217

Contd.....

# Utility Pipe Fittings Zinc Coated

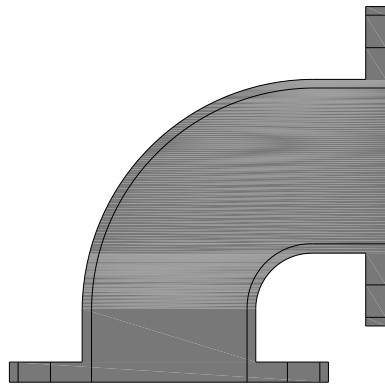

ANSI/AWWA C110/A21.10  
**FLANGE FITTINGS**  
**ZINC COATED**

## **PRICE LIST**

**Effective January 14, 2019.**

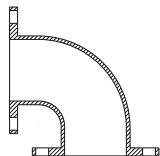

**FLANGE BENDS**  
**90° (1/4)**

Size (in)	Item No.	List Price (\$)	Wt. (lb.)
2	DFB9002Z	120.00	14
3	DFB9003Z	152.00	25
4	DFB9004Z	234.00	45
6	DFB9006Z	362.00	65
8	DFB9008Z	595.00	105
10	DFB9010Z	939.00	165
12	DFB9012Z	1,217.00	235
14	DFB9014Z	1,594.00	290
16	DFB9016Z	1,974.00	370
18	DFB9018Z	2,609.00	450
20	DFB9020Z	3,203.00	580
24	DFB9024Z	5,250.00	900
30	DFB9030Z	9,016.00	1430
36	DFB9036Z	13,362.00	2135
42	DFB9042Z	22,482.00	3055
48	DFB9048Z	30,119.00	4095
54	DFB9054Z	POA	3740

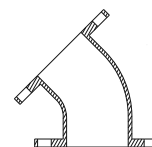
**FLANGE BENDS**  
**45° (1/8)**

Size (in)	Item No.	List Price (\$)	Wt. (lb.)
2	DFB4502Z	123.00	12
3	DFB4503Z	117.00	20
4	DFB4504Z	207.00	40
6	DFB4506Z	320.00	55
8	DFB4508Z	492.00	90
10	DFB4510Z	790.00	130
12	DFB4512Z	1,029.00	195
14	DFB4514Z	1,218.00	220
16	DFB4516Z	1,548.00	280
18	DFB4518Z	2,014.00	325
20	DFB4520Z	2,700.00	430
24	DFB4524Z	3,736.00	630
30	DFB4530Z	7,803.00	1120
36	DFB4536Z	12,227.00	1755
42	DFB4542Z	19,122.00	2600
48	DFB4548Z	26,330.00	3580
54	DFB4554Z	POA	2735

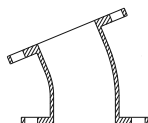
**FLANGE BENDS**  
**22½° (1/16)**

Size (in)	Item No.	List Price (\$)	Wt. (lb.)
2	DFB2202Z	POA	12
3	DFB2203Z	127.00	20
4	DFB2204Z	206.00	40
6	DFB2206Z	307.00	55
8	DFB2208Z	480.00	90
10	DFB2210Z	756.00	135
12	DFB2212Z	1,104.00	205
14	DFB2214Z	1,395.00	225
16	DFB2216Z	1,600.00	285
18	DFB2218Z	2,076.00	335
20	DFB2220Z	2,863.00	435
24	DFB2224Z	4,209.00	640
30	DFB2230Z	7,908.00	1135
36	DFB2236Z	12,470.00	1790
42	DFB2242Z	19,603.00	2665
48	DFB2248Z	26,957.00	3665
54	DFB2254Z	POA	2260

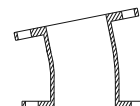
**FLANGE BENDS**  
**11¼° (1/32)**

Size (in)	Item No.	List Price (\$)	Wt. (lb.)
2	DFB1102Z	POA	12
3	DFB1103Z	127.00	20
4	DFB1104Z	240.00	40
6	DFB1106Z	372.00	55
8	DFB1108Z	507.00	90
10	DFB1110Z	838.00	135
12	DFB1112Z	1,273.00	205
14	DFB1114Z	1,450.00	225
16	DFB1116Z	1,767.00	285
18	DFB1118Z	2,076.00	335
20	DFB1120Z	2,863.00	435
24	DFB1124Z	4,425.00	645
30	DFB1130Z	8,013.00	1150
36	DFB1136Z	12,575.00	1805
42	DFB1142Z	19,712.00	2680
48	DFB1148Z	27,177.00	3695
54	DFB1154Z	POA	2100

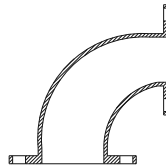

**90° REDUCING BENDS**

Size (in)	Item No.	List Price (\$)	Wt. (lb.)
4 X 3	DFBR0403Z	184.00	35
6 X 3	DFBR0603Z	348.00	45
6 X 4	DFBR0604Z	343.00	55
6 X 5	DFBR0605Z	348.00	
8 X 4	DFBR0804Z	467.00	80
8 X 6	DFBR0806Z	532.00	90
10X 4	DFBR1004Z	807.00	105
10X 6	DFBR1006Z	838.00	125
10X 8	DFBR1008Z	930.00	150
12X 4	DFBR1204Z	868.00	
12X 6	DFBR1206Z	992.00	165
12X 8	DFBR1208Z	1,168.00	190
12X10	DFBR1210Z	1,238.00	220
14X 6	DFBR1406Z	1,179.00	144
14X 8	DFBR1408Z	1,333.00	200
14X10	DFBR1410Z	1,487.00	260
14X12	DFBR1412Z	1,674.00	270
16X 6	DFBR1606Z	POA	220
16X 8	DFBR1608Z	1,487.00	240
16X10	DFBR1610Z	1,735.00	344
16X12	DFBR1612Z	1,920.00	373
16X14	DFBR1614Z	2,076.00	330
18X 6	DFBR1806Z	POA	260
18X 8	DFBR1808Z	POA	280
18X10	DFBR1810Z	2,045.00	320
18X12	DFBR1812Z	2,169.00	465
18X14	DFBR1814Z	2,385.00	370
18X16	DFBR1816Z	2,599.00	410
20X 6	DFBR2006Z	POA	320
20X 8	DFBR2008Z	POA	345
20X10	DFBR2010Z	POA	385
20X12	DFBR2012Z	2,989.00	415
20X14	DFBR2014Z	3,338.00	518
20X16	DFBR2016Z	3,258.00	533
20X18	DFBR2018Z	3,456.00	515
24X 6	DFBR2406Z	POA	480
24X 8	DFBR2408Z	POA	505
24X10	DFBR2410Z	POA	545
24X12	DFBR2412Z	3,784.00	575
24X14	DFBR2414Z	4,178.00	595
24X16	DFBR2416Z	4,507.00	635
24X18	DFBR2418Z	4,549.00	675
24X20	DFBR2420Z	4,867.00	740

Size (in)	Item No.	List Price (\$)	Wt. (lb.)
30X12	DFBR3012Z	5,852.00	840
30X14	DFBR3014Z	7,206.00	860
30X16	DFBR3016Z	6,269.00	900
30X18	DFBR3018Z	9,306.00	940
30X20	DFBR3020Z	9,870.00	1005
30X24	DFBR3024Z	8,396.00	1165
36X12	DFBR3612Z	8,326.00	1195
36X14	DFBR3614Z	10,655.00	1215
36X16	DFBR3616Z	8,745.00	1255
36X18	DFBR3618Z	11,270.00	1295
36X20	DFBR3620Z	11,672.00	1315
36X24	DFBR3624Z	11,043.00	1520
36X30	DFBR3630Z	12,816.00	1785
42X12	DFBR4212Z	POA	1655
42X14	DFBR4214Z	14,802.00	1675
42X16	DFBR4216Z	12,616.00	1715
42X18	DFBR4218Z	16,680.00	1755
42X20	DFBR4220Z	16,503.00	1820
42X24	DFBR4224Z	14,565.00	1980
42X30	DFBR4230Z	17,249.00	2245
42X36	DFBR4236Z	24,934.00	2600
48X12	DFBR4812Z	15,998.00	2175
48X14	DFBR4814Z	19,150.00	2195
48X16	DFBR4816Z	16,440.00	2235
48X18	DFBR4818Z	23,160.00	2275
48X20	DFBR4820Z	25,026.00	2340
48X24	DFBR4824Z	23,830.00	2500
48X30	DFBR4830Z	26,047.00	2765
48X36	DFBR4836Z	26,204.00	3115
48X42	DFBR4842Z	34,457.00	3580
54X12	DFBR5412Z	POA	1990
54X14	DFBR5414Z	POA	2015
54X16	DFBR5416Z	POA	2055
54X18	DFBR5418Z	POA	2095
54X20	DFBR5420Z	POA	2160
54X24	DFBR5424Z	POA	2320
54X30	DFBR5430Z	POA	2585
54X36	DFBR5436Z	POA	2940
54X42	DFBR5442Z	POA	3395
54X48	DFBR5448Z	POA	3565

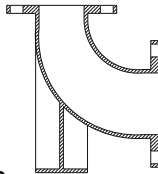

**90° REDUCING BASE BENDS**  
 (WITH BASE UNDER SMALL END)

R - Available multiple size reductions.

Size (in)	Item No.	List Price (\$)	Wt. (lb.)
4 X 3	DFBBSDR0403Z	POA	45
6 X 4	DFBBSDR0604Z	POA	75
8 X 4	DFBBSDR0804Z	POA	120
8 X 6	DFBBSDR0806Z	POA	130
10X 6	DFBBSDR1006Z	POA	170
10X 8	DFBBSDR1008Z	POA	195
12X 6	DFBBSDR1206Z	POA	230
12X 8	DFBBSDR1208Z	POA	255
12X10	DFBBSDR1210Z	POA	285
14X R	DFBBSDR14Z	POA	
16X R	DFBBSDR16Z	POA	
18X R	DFBBSDR18Z	POA	
20X R	DFBBSDR20Z	POA	
24X R	DFBBSDR24Z	POA	
30X R	DFBBSDR30Z	POA	
36X R	DFBBSDR36Z	POA	
42X R	DFBBSDR42Z	POA	
48X R	DFBBSDR48Z	POA	
54X R	DFBBSDR54Z	POA	

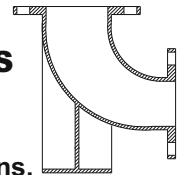
**90° REDUCING BASE BENDS**  
 (WITH BASE UNDER LARGE END)

R - Available multiple size reductions.

Size (in)	Item No.	List Price (\$)	Wt. (lb.)
4 X 3	DFBBLDR0403Z	POA	45
6 X 4	DFBBLDR0604Z	POA	75
8 X 4	DFBBLDR0804Z	POA	120
8 X 6	DFBBLDR0806Z	POA	130
10X 6	DFBBLDR1006Z	POA	170
10X 8	DFBBLDR1008Z	POA	195
12X 6	DFBBLDR1206Z	POA	230
12X 8	DFBBLDR1208Z	POA	255
12X10	DFBBLDR1210Z	POA	285
14X R	DFBBLDR14Z	POA	
16X R	DFBBLDR16Z	POA	
18X R	DFBBLDR18Z	POA	
20X R	DFBBLDR20Z	POA	
24X R	DFBBLDR24Z	POA	
30X R	DFBBLDR30Z	POA	
36X R	DFBBLDR36Z	POA	
42X R	DFBBLDR42Z	POA	
48X R	DFBBLDR48Z	POA	
54X R	DFBBLDR54Z	POA	

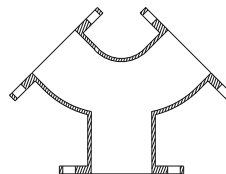
**TRUE WYES**

Size (in)	Item No.	List Price (\$)	Wt. (lb.)
4 X 4 X 4	DFYT040404Z	312.00	50
6 X 4 X 4	DFYT060404Z	POA	75
6 X 6 X 6	DFYT060606Z	497.00	80
8 X 6 X 6	DFYT080606Z	POA	120
8 X 8 X 4	DFYT080804Z	POA	
8 X 8 X 8	DFYT080808Z	868.00	125
10 X 10 X 6	DFYT101006Z	POA	
10 X 8 X 8	DFYT100808Z	962.00	155
10 X 10 X 10	DFYT101010Z	1,149.00	185
12 X 12 X 6	DFYT121206Z	POA	
12 X 12 X 8	DFYT121208Z	POA	

Size (in)	Item No.	List Price (\$)	Wt. (lb.)
12 X 12 X 10	DFYT121210Z	POA	
12 X 12 X 12	DFYT121212Z	1,858.00	300
14 X 14 X 14	DFYT141414Z	POA	415
16 X 16 X 16	DFYT161616Z	POA	580
18 X 18 X 18	DFYT181818Z	POA	680
20 X 20 X 20	DFYT202020Z	POA	960
24 X 24 X 24	DFYT242424Z	POA	1370
30 X 30 X 30	DFYT303030Z	POA	80
36 X 36 X 36	DFYT363636Z	POA	120
42 X 42 X 42	DFYT424242Z	POA	125
48 X 48 X 48	DFYT484848Z	POA	120





**FLANGE TEES**

Contd.....

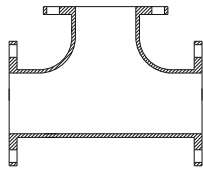

Size (in)	Item No.	List Price (\$)	Wt. (lb.)
36X30	DFT3630Z	20,895.00	3000
36X36	DFT3636Z	19,430.00	3160
42X12	DFT4212Z	23,279.00	3165
42X14	DFT4214Z	23,316.00	3170
42X16	DFT4216Z	23,389.00	3180
42X18	DFT4218Z	23,425.00	3185
42X20	DFT4220Z	23,575.00	3205
42X24	DFT4224Z	23,868.00	3245
42X30	DFT4230Z	30,339.00	4125
42X36	DFT4236Z	39,422.00	5360
42X42	DFT4242Z	41,040.00	5580
48X12	DFT4812Z	31,738.00	4315
48X14	DFT4814Z	31,738.00	4315
48X16	DFT4816Z	31,846.00	4330
48X18	DFT4818Z	31,846.00	4330
48X20	DFT4820Z	31,993.00	4350
48X24	DFT4824Z	32,250.00	4385
48X30	DFT4830Z	32,767.00	4455
48X36	DFT4836Z	40,856.00	7035
48X42	DFT4842Z	52,917.00	7195
48X48	DFT4848Z	54,315.00	7385
54X12	DFT5412Z	POA	4435
54X14	DFT5414Z	POA	4435
54X16	DFT5416Z	POA	4450
54X18	DFT5418Z	POA	4460
54X20	DFT5420Z	POA	4480
54X24	DFT5424Z	POA	4515
54X30	DFT5430Z	POA	4615
54X36	DFT5436Z	POA	4695
54X42	DFT5442Z	POA	5740
54X48	DFT5448Z	POA	5850
54X54	DFT5454Z	POA	6025

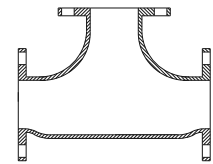
**FLANGE TEES - BULL HEAD**

Size (in)	Item No.	List Price (\$)	Wt. (lb.)
4 X 4 X 6	DFTBH040406Z	754.00	90
6 X 6 X 8	DFTBH060608Z	876.00	140
8 X 8 X 10	DFTBH080810Z	1,610.00	260
8 X 8 X 12	DFTBH080812Z	1,633.00	291
10X10X12	DFTBH101012Z	POA	355

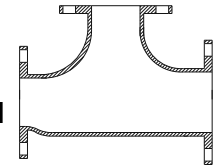
**FLANGE TEES - REDUCING ON THE RUN**

Size (in)	Item No.	List Price (\$)	Wt. (lb.)
4 X 3 X 3	DFTROR040303Z	POA	55
6 X 4 X 4	DFTROR060404Z	559.00	103
6 X 4 X 6	DFTROR060406Z	559.00	108
8 X 6 X 4	DFTROR080604Z	777.00	146
8 X 6 X 6	DFTROR080606Z	900.00	148
8 X 6 X 8	DFTROR080608Z	992.00	145
10X 6 X 6	DFTROR100606Z	1,804.00	275
10X 6 X 10	DFTROR100610Z	1,776.00	305
10X 8 X 6	DFTROR100806Z	1,815.00	280
10X 8 X 8	DFTROR100808Z	1,916.00	302
10X 8 X 10	DFTROR100810Z	1,965.00	325
12X 6 X 6	DFTROR120606Z	2,244.00	340
12X 6 X 8	DFTROR120608Z	2,348.00	360
12X 8 X 6	DFTROR120806Z	2,302.00	355
12X 8 X 8	DFTROR120808Z	2,432.00	375
12X 8 X 12	DFTROR120812Z	2,723.00	420
12X10X 6	DFTROR121006Z	2,248.00	390
12X10X 8	DFTROR121008Z	2,593.00	400
12X10X10	DFTROR121010Z	2,723.00	420
12X10X12	DFTROR121012Z	2,852.00	440















NOTES



# SIP Industries

Quality Manufacturers Since 1960

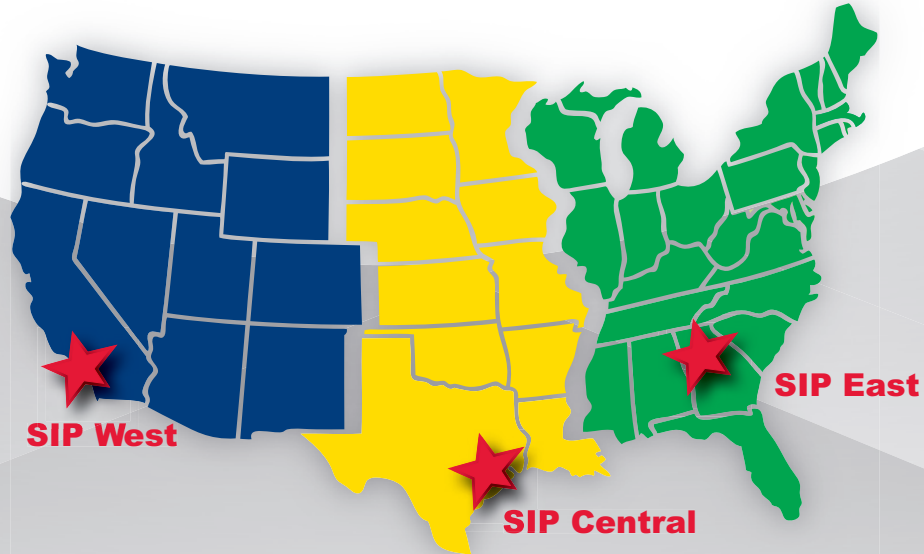

## PRODUCT LINE

### AWWA DI Fittings & Accessories

- C153 Compact MJ Fittings and Acc. 2" - 64"
- C110 Full Body MJ Fittings 2" - 64"
- C153 Trim Tyton® Push-On Fittings 4" - 24"
- C110 Flange Fittings 2" - 64"
- MJ x MJ Adapter for Connecting MJ Bells 3" - 24"
- Stainless Steel & Blue T-Bolts
- Made in India, China & Mexico
- Bare, Cement, Zinc, FBE & Other Linings

### Joint Restraint System

- EZD Joint Restraint for DI Pipe 3" - 48"
- EZDTP Joint Restraint Tandem for DI Pipe 3" - 48"
- EZDPTP Joint Restraint for Push-On Joints DI Pipe 3" - 48"
- Ductile Iron Retainer Glands 3" - 30"
- FAR / FAH Flange Adapter for DI Pipe 3" - 48"
- EZFA Restrained Flange Adapter for DI and PVC Pipe 3" - 36"
- EZPVC Joint Restraint for PVC Pipe 3" - 36"
- ULTRA Joint Restraint for PVC Pipe 4" - 12"
- EZPVCPTP Joint Restraint for Push-On Joints PVC Pipe 14" - 36"
- PTPVC Pipe to Pipe Restraint 4" - 48"
- PTPDF Pipe to MJ Fittings Restraint 4" - 48"
- PTPFC Pipe to PVC Fittings Restraint 4" - 12"
- Made in China & USA
- EZ Shield or Shop Coating

### Municipal Construction Castings

- Manhole Rings and Cover
- Frames and Grates
- Valve Boxes and Service Boxes
- Water Meter Covers and Boxes
- Cleanout and Monument Boxes
- Detectable Warning Plates
- Extension Rings
- Trench Grates and Tree Grates
- Made in India & USA

### Fabrication Products for DI Pipe

- High Hub Flanges Class 150 and 250. 3" - 64"
- Threaded Bell Flanges 3" - 48"
- Anchor Flanges 3" - 60"
- Filler Flanges 4" - 30"

### Other Products and Services

- All Thread Rod
- Pipe Lube and Hydraulic Cement
- Socket Clamps and Lugs
- Flange Packs
- OEM Castings



**SIP CORPORATE** 8876 Gulf Freeway, Suite 500, Houston, TX 77017

**SIP CENTRAL** 2900 Patio Drive, Houston, TX 77017

**SIP EAST** 600 Rayloc Drive, Atlanta, GA 30336

**SIP WEST** 8333 Almeria Avenue, Fontana, CA 92335

Phone: 877-921-6111 or 713-923-6111 | Fax: 713-923-6114 | [www.sipindustries.com](http://www.sipindustries.com) | [sales@sipindustries.com](mailto:sales@sipindustries.com)